

Department for Transport



NPTG - Nation Public Transport Gazetteer
&
NaPTAN - National Public Transport Access Node
database

<http://www.dft.gov.uk/naptan>

NPTG and NaPTAN Schema Guide.

NaPTAN & NPTG v2.5

Version History

Schema	Version	Date		Audience
2.0a	0.1 Preliminary Draft	03 04 2004	RM	Internal
2.0c	0.24 Revise Bay	30 08 2004	NJSK	Review
2.0	0.31 Corrections to csv & modification attributes	10 03 2005	NJSK	Issued
2.0	0.33 Errata NPTG Disco, clarify common name guidance	16 05 2005	NJSK	Issued
2.0	0.35 Tram as MET, Character set use, errata	01 07 2005	NJSK	Issued
2.0	0.36 Clarify use of NPTG Locality & Stop Areas, versions	04 08 2005	NJSK	Issued
2.1	0.37 Make street & Landmark optional. Cover 2.1	05 09 2005	NJSK	Issued
2.1	0.38 Support AnnotatedCoachRef on -street stops	08 09 2005	NJSK	Issued
2.1	0.39 Update UML Diagrams	18 09 2005	NJSK	Issued
2.1	0.40 Clarify Use of Ampersand	10 10 2005	NJSK	Issued
2.1	0.41 Update Trunk Localities, Met process	10 10 2005	NJSK	Issued
2.1	0.42 Correct Errata in tables	26 01 2006	NJSK	Issued
2.1	0.43 Add notes on change detection. Add ITSO use of NaPTAN, corrections. Correct Stop area rename	15.11.2006, 10.07.2007	NJSK	Issued
2.2	Add archived status	29.08.2007	NJSK	Review
2.4a	0.48 Revise diagrams and other 2.4 changes	10.02.2010	NJSK	Review
2.4a	0.48-2 Revise XML diagrams and other TXC 2.4 changes	19.03.2010	NJSK	Review
2.4a	0.48-3 Textual review and some other changes	22.03.2010	RS	Review
2.4a	0.48-4 Corrections and add Northern Ireland	25.03.2010	NJSK	NJSK
2.4a	0.49 Corrections	25.04.2010	NJSK	Consult
2.4b	0.50 Corrections	15.06.2010	NJSK	Consult
2.4b	0.52 Update private stop description to use flag (drop BCP)	16.09.2010	NJSK	Issued
2.4b	0.53 Add extra stop types for Cable car etc	19.10.2010	NJSK	Issued
2.4b	0.54 Clarify bearing, Fix typos	30.11.2010	NJSK	Review
2.4	0.56 Update Diagrams, Issue as 2.4	30.12.2010	NJSK	Issued
2.4	0.57 Clarify guidance on stations refs	04.01.2012	NJSK	Issued
2.5a	0.58 Support for Eire and Stop Accessibility	14.03.2013	NJSK	Consult
2.5a	0.63 Support for Eire and Stop Accessibility -revised	22.04.2013	NJSK	Consult
2.5b	0.64 Add public holiday to day time, add POI Venue. Corrections, revise UML diagrams.	22.04.2013	NJSK	Consult
2.5b	0.65 Correct spelling of Principal timing point in diagrams	05.09.2013	NJSK	Consult
2.5	0.66 Minor corrections to diagrams.	05.09.2013	NJSK	Review
2.5	0.67 Minor corrections	0801.2014	NJSK	Issued

Prepared By:

Nicholas Knowles

Email: schemer@naptan.org.uk

Prepared For:



Transport Direct, Department for Transport
2/17 Great Minster House,
33 Horseferry Road,
London, SW1P 4DR

© Crown Copyright 2000-2014

The content in this document may be reproduced free of charge in any format or media without requiring specific permission, subject to the [NaPTAN Terms & Conditions of use](http://www.naptan.org.uk), viewable at <http://www.naptan.org.uk>. This is subject to the material not being used in a derogatory manner or in a misleading context. The source of the material must be acknowledged as Crown Copyright and the title of the content must be included when being reproduced as part of another publication or service.

CONTENTS

<i>Section</i>	<i>Page</i>
1 INTRODUCTION	14
1.1 NPTG Components	14
1.2 NaPTAN Components	14
1.3 NPTG and NaPTAN Users	14
1.4 Motivation	15
1.5 Antecedents	15
1.6 Document Structure	16
1.7 Intellectual Property Rights	17
1.7.1 <i>NPTG and NaPTAN</i> Schema	17
1.7.2 <i>NPTG</i> Database	17
1.7.3 <i>NaPTAN</i> Database	17
1.8 Versioning	17
1.9 Changes in Releases	17
1.9.1 Standardisation 2.0	17
1.9.2 Functional Enhancements 2.0	18
1.9.3 Name Changes in Release 2.0	18
1.9.4 Changes in Release 2.1	18
1.9.5 Changes in Release 2.2	19
1.9.6 Changes in Release 2.3	19
1.9.7 Changes in Release 2.4	19
1.9.8 Changes in Release 2.5	19
1.10 Content Not Covered by NaPTAN	19
1.11 Naming Conventions	20
1.12 Presentation Conventions	20
1.12.1 XML Elements in Text	20
1.12.2 UML Diagrams	20
1.12.3 XML Structure Diagrams	20
1.13 Related Transport Information Standards	22
1.14 Acknowledgments	23
2 INTRODUCTION TO NAPTAN AND THE NPTG	25
2.1 The Purpose of the National Public Transport Gazetteer	25
2.1.1 The NPTG Database	25
2.1.2 The NPTG XML Schemas	25
2.1.3 The NPTG CSV Exchange Format	25
2.2 The Purpose of NaPTAN	25
2.2.1 NaPTAN Identifiers	25
2.2.2 The NaPTAN Database	26
2.2.3 The NaPTAN XML Schema	26
2.2.4 The NaPTAN CSV Exchange Format	26
2.2.5 NaPTAN Process	26
2.3 How are NPTG and NaPTAN used?	27
2.3.1 Scenario #1: Compilation and Distribution of <i>NPTG</i> Data	27
2.3.2 Scenario #2: Gathering and Distribution of <i>NaPTAN</i> Stop Data	27
2.3.3 Scenario #3: Exchange of <i>NaPTAN</i> Data within <i>TransXChange</i>	28
2.3.4 Scenario #4: Using NPTG and NaPTAN Data in a Place Finder	28
2.3.5 Scenario #5: Using NPTG and NaPTAN Data in a Stop Finder	29
2.3.6 Scenario #6: Using NaPTAN Data for real-time departures	29
2.4 Document Validation	29

3	SHORT TOUR OF THE NPTG AND NAPATAN REFERENCE MODELS	31
3.1	The National Gazetteer Model	31
3.1.1	Topographical Elements	31
3.1.2	Administrative Elements	34
3.1.3	NPTG Element Hierarchies	37
3.2	Populating the National Gazetteer	42
3.2.1	Choosing Administrative Areas	42
3.2.2	Choosing NPTG Districts	42
3.2.3	Choosing & Grouping NPTG Localities	42
3.2.4	Naming NPTG Localities	43
3.2.5	Geocoding NPTG Localities - Locations	46
3.3	The NaPTAN Model	47
3.3.1	Overview of NaPTAN Model	47
3.3.2	NaPTAN Stop Point & Stop Area Types	51
3.3.3	NaPTAN Stop Accessibility	56
3.3.4	NaPTAN Networks and Tariff Zones	57
3.3.1	NaPTAN Points Of Interest	58
3.3.2	NaPTAN Point Of Interest details	58
3.4	NaPTAN Element Hierarchies	59
3.5	Populating the NaPTAN Database	63
3.5.1	Choosing NaPTAN Points	63
3.5.2	Allocating an AtcoCode for a NaPTAN Stop Point	65
3.5.3	Allocating NaPTAN (SMS) Codes for NaPTAN Stop Points	65
3.5.4	Choosing NaPTAN Stop Areas	66
3.5.5	The Naming of Stop Points and Stop Areas	67
3.5.6	Bus Stop Naming Styles	69
3.5.7	Naming Of Particular Types of Stop	72
3.5.8	Naming of Stop Areas	72
3.5.9	The Classifying of Bus Stops and Other PTANs	73
3.5.10	Associating Stop Points and Stop Areas with NPTG Localities	73
3.5.11	Geocoding of Stop Points - Location	73
3.5.12	Populating Accessibility data	76
3.6	NPTG Discovery Model	79
3.6.1	Overview of NPTG Discovery Model	79
3.6.2	Informational Service Elements	79
3.6.3	Service Discovery	82
3.7	Summary of NPTG and NaPTAN Entities and Identifiers	84
3.7.1	Private codes	84
4	SCHEMAS	85
5	NPTG SCHEMA, STRUCTURE AND ELEMENTS	86
5.1	NationalPublicTransportGazetteer Root Element	86
5.1.1	NationalPublicTransportGazetteer Element Attributes	86
5.1.2	NationalPublicTransportGazetteer Child Elements	86
5.2	Region Element	88
5.3	AdministrativeArea Element	88
5.4	NPTG Locality Element	91
5.4.1	Identification	91
5.4.2	Associations	91
5.4.3	Other classifications	91

5.5	NPTG Locality / Descriptor Element	92
5.6	NPTG District Element	93
5.7	PlusbusZone Element	93
6	NAPTAN SCHEMA, STRUCTURE AND ELEMENTS	95
6.1	NaPTAN Root Element	95
6.1.1	NaPTAN Element Attributes	95
6.1.2	NaPTAN Child Elements	96
6.2	StopPoint Element	97
6.3	Identifying the Stop – StopIdentifierGroup	98
6.4	Descriptors of a Stop – SiteDescriptionGroup	99
6.4.1	Descriptor Element	99
6.4.2	Additional Descriptors	100
6.4.3	Place Element	100
6.5	Associations of a Stop – StopReferencesGroup	101
6.6	Other Information – StopFurtherDetailsGroup	102
6.7	StopClassification Element	103
	StopClassification / On-Street Elements	104
6.7.1	StopPoint / StopClassification / On-Street Bus Element	104
6.7.2	On-Street Taxi Element	107
6.7.3	On-Street Car Element (+NaPT v2.4)	107
6.8	StopClassification / Off-Street Elements	107
6.8.1	Off-Street Air Element	107
6.8.2	Off-Street Ferry Element	108
6.8.3	Off-Street Rail Element	109
6.8.4	Off-Street Metro Element	110
6.8.5	Off-Street BusAndCoach Element	111
6.8.6	Off-Street Telecabine (Lift & Cable Car) Element (+NaPT v2.4)	112
6.9	StopAvailability Element	113
6.10	StopAccessibility Element (V2.5)	114
6.10.1	SiteAccessibility Group (V2.5)	115
6.10.1	StopAccessibility Group (V2.5)	116
6.10.2	AccessVehicle Element	117
6.10.3	DayType Element	118
6.10.4	BankHolidays Element	119
6.11	StopArea Element	120
6.12	Network Element (+NaPT v2.5)	122
6.13	TariffZone Element (+NaPT v2.5)	123
6.14	PointOfInterest Element (+NaPT v2.5)	124
6.15	PointOfInterestClassification / Off-Street Elements	125
6.15.1	PointOfInterestClassification Element (+NaPT V2.5)	125
7	NPTG DISCOVERY SCHEMA, STRUCTURE AND ELEMENTS	126
7.1	NptgDiscovery Root Element	126
7.1.1	NptgDiscovery Element Attributes	126
7.1.2	NptgDiscovery Child Elements	127
7.2	WebApplication Element	128
7.2.1	UsedBy Element	129
7.3	TrustedServer Element	130
7.4	AdjacentRegionPoint Element	131
7.5	CallCentre Element	131
7.5.1	Availability Element	132

	7.5.2 Day Types Element	133
	7.5.3 Holiday Types Element	134
	7.5.4 OpeningHours Element	135
	7.5.5 TelephoneContactStructure Element	136
7.6	TrunkLocality Element	136
8	COMMON SCHEMA ELEMENTS	137
8.1	Duration Simple Type	137
8.2	Location Element	137
	8.2.1 Translation Element	138
8.3	Bearing Element	139
9	NAPTAN EXAMPLES	140
9.1	Example 1: Poles Both Sides of the Road with One Landmark	141
	9.1.1 NaPTAN StopArea Definition: Example 1	142
	9.1.2 NaPTAN StopPoint Definitions: Example 1	142
	9.1.3 Names in Context	142
9.2	Example 2: Poles Both Sides with Different Common Names and Landmarks	143
	9.2.1 NaPTAN StopArea Definitions: Example 2	144
	9.2.2 NaPTAN StopPoint Definitions: Example 2	144
	9.2.3 Names in Context	145
9.3	Example 3: Pole One Side Only with Landmark	146
	9.3.1 NaPTAN StopArea Definitions: Example 3	147
	9.3.2 NaPTAN StopPoint Definitions: Example 3	147
	9.3.3 Names in Context	148
9.4	Example 4: Unmarked Bus Stop on One Side of a Road with No Landmark	149
	9.4.1 NaPTAN StopPoint Definition: Example 4	150
	9.4.2 Names in Context	150
9.5	Example 5: Bus Interchange	151
	9.5.1 NaPTAN StopArea Definition: Example 5	152
	9.5.2 NaPTAN StopPoint Definitions: Example 5	152
	9.5.3 Names in Context	152
9.6	Example 6: Hail & Ride Stop Sections	153
	9.6.1 NaPTAN StopPoint Definition: Example 6	154
	9.6.2 Names in Context	154
9.7	Example 7: Flexible Service Stop Zones	155
	9.7.1 NaPTAN StopPoint Definitions: Example 7	156
	9.7.2 Names in Context	156
9.8	Example 8: Railway Station with Bus and Taxi	158
	9.8.1 NaPTAN StopArea Definitions: Example 8	160
	9.8.2 NaPTAN StopPoint Definitions: Example 8	160
	9.8.3 Names in Context	161
9.9	Example 9: Metro Station with Bus & Light Rail	164
	9.9.1 NaPTAN StopArea Definitions: Example 9	167
	9.9.2 NaPTAN StopPoint Definitions: Example 9	167
	9.9.3 Names in Context	168
9.10	Example 10: Bus Station with Bays	169
	9.10.1 NaPTAN StopArea Definitions: Example 10	171
	9.10.2 NaPTAN StopPoint Definitions: Example 10	171
	9.10.3 Names in Context	172
9.11	Example 11: Major Airport	173

10	NAMING & CODING CONVENTIONS	176
10.1	Naming of Elements	176
10.1.1	Use of Camel Case	176
10.1.2	Use of Standard Name Suffixes	176
10.1.3	Meaningful Names	176
10.1.4	Standardised Terminology	177
10.1.5	Semantically Significant Order	177
10.2	Typing of Elements	177
10.3	Element Constraints	177
10.4	Use of Attributes	177
10.5	Implementation of Model Relationships	178
10.6	Data Rights attribute	178
11	VERSIONING	179
11.1	Version Numbering Convention	179
11.2	Resource Versions	179
11.2.1	Schema URI version	179
11.2.2	Namespace URI version	179
11.2.3	Schema Version	179
11.2.4	Package Versions	180
11.2.5	Data Element Version	180
11.2.6	Use of the Status Attribute	182
11.2.7	Detecting Changes on Different systems - The NaPTAN Distributed Data process	185
11.2.8	Summary of Use of Data Version Attributes	187
11.2.9	Referential Integrity of references	187
11.3	Packages	189
11.3.1	NPTG Package & Model Dependencies	189
11.3.2	NPTG Discovery Package & Model Dependencies	190
11.3.3	NaPTAN Package & Model Dependencies	191
12	RELATION TO OTHER STANDARDS	194
12.1	Transmodel Compliance	194
12.1.1	Transmodel Terminology	194
12.2	ITSO Interoperability	194
13	NATIONAL LANGUAGE SUPPORT	195
13.1	Text Content Types	195
13.1.1	Use of Structured Text	195
13.1.2	Use of Free Text	195
13.1.3	Use of Aliased Free Text	195
14	INTEGRITY RULES	197
14.1	NPTG Integrity Rules	197
14.1.1	Syntactic Integrity Rules	197
14.1.2	Semantic Integrity Rules	198
14.2	NPTG Discovery Integrity Rules	198
14.2.1	Syntactic Integrity Rules	198
14.2.2	Semantic Integrity Rules	198
14.3	NaPTAN Integrity Rules	199

14.3.1	Syntactic Integrity Rules	199
14.3.2	Semantic Integrity Rules	200
15	APPENDICES	203
15.1	2.0 Changes Since 1.1	203
15.2	2.1 Changes Since 2.0	203
15.3	References	204
15.3.2	JourneyWeb	204
15.4	Standard Abbreviations for Topographical Features	207
15.4.1	Terms for Relationship	207
15.4.2	Topographical Features	207
15.4.3	Common Acronyms	207
15.4.4	Common Adjectives	207
15.5	NPTG CSV Exchange Formats	208
15.5.1	NPTG CSV 1.2 CSV Format Overview [Deprecated]	209
15.5.2	NPTG CSV 2.1 CSV Format Overview	210
15.5.3	NPTG Discovery CSV 2.1 CSV Format Overview	211
15.6	NPTG: CSV Files	211
15.6.1	NPTG: Regions CSV table	212
15.6.2	NPTG: AdminAreas CSV table	212
15.6.3	NPTG: District CSV table	212
15.6.4	NPTG: Locality CSV table*	213
15.6.5	NPTG: LocalityAlternativeNames CSV table*	213
15.6.6	NPTG: LocalityHierarchy CSV table*	214
15.6.7	NPTG: AdjacentLocalities CSV table+	214
15.6.8	NPTG Plusbuszones CSV table+	214
15.6.9	NPTG PlusbuszonesMapping CSV table+	214
15.7	NPTG Discovery: CSV Files	214
15.7.1	NPTG Discovery: AdjacentRegionPoints CSV table+	214
15.7.2	NPTG Discovery: CallCentres CSV table+	215
15.7.3	NPTG Discovery: CallCentresAreas CSV table+	215
15.7.4	NPTG Discovery: TrustedServer CSV table +	215
15.7.5	NPTG Discovery: WebApplications CSV table +	216
15.7.6	NPTG Discovery: WebAppCapabilities CSV table +	216
15.7.7	NPTG Discovery: RegionApplications CSV table +	216
15.7.8	NPTG Discovery: AdminAreaApplications CSV table +	216
15.7.9	NPTG Discovery: LocalityApplications CSV table +	216
15.7.10	NPTG Discovery: StopPointApplications CSV table +	217
15.8	NAPTAN CSV Format	217
15.8.1	NaPTAN 1.1 CSV Exchange Format Overview	218
15.8.2	NaPTAN 2.1 CSV Exchange Format Overview	219
15.9	NaPTAN: CSV Files	220
15.9.1	NaPTAN: StopPoint CSV table	220
15.9.2	NaPTAN: Hail & Ride CSV Table	221
15.9.3	NaPTAN: Flexible CSV Table	221
15.9.4	NaPTAN: AlternativeDescriptor Table	221
15.9.5	NaPTAN: StopLocalities Table	222
15.9.6	NaPTAN: StopAvailabilities Table	222
15.9.7	NaPTAN: StopsInStopArea Table	222
15.9.8	NaPTAN: AirReferences Table	223
15.9.9	NaPTAN: RailReferences Table	223
15.9.10	NaPTAN: FerryReferences Table	223
15.9.11	NaPTAN: MetroReferences Table	223

15.9.12 NaPTAN: CoachReferences Table	224
15.9.13 NaPTAN: LocalityMainAccessPoints Table	224
15.9.14 NaPTAN: StopPlusBusZones Table	224
15.9.15 NaPTAN: StopAreas (Groups Table)	224
15.9.16 NaPTAN: StopAreaHierarchy Table	225
15.10 Common CSV Types	226
15.11 ATCO & AdministrativeArea Codes	227
15.12 Index	229

List of Figures

Figure 1-1 – Name changes in NaPTAN 2.0	18
Figure 1-2 – XML Spy Diagram: Sequence	21
Figure 1-3 – XML Spy Diagram: Choice	21
Figure 1-4 – XML Spy Diagram: Multiplicity	22
Figure 3-1 – UML Diagram of NPTG Model: Introduction	31
Figure 3-2 – UML Diagram of NPTG Locality Model	33
Figure 3-3 – UML Diagram of NPTG Administrative Model: Overview	34
Figure 3-4 – UML Diagram of Main NPTG Model: Further elements	35
Figure 3-5 – UML Diagram of Main NPTG Model: Detail	36
Figure 3-6 – UML Diagram of NPTG Locality Element Hierarchy	37
Figure 3-7 – UML Diagram of Administrative Element Hierarchy	37
Figure 3-8 – UML Diagram of Locality Data types	38
Figure 3-9 – UML Diagram of Administrative Data types	39
Figure 3-10 – UML Diagram of Location Data Types	40
Figure 3-11 – UML Diagram of NaPT Utility Data Types	40
Figure 3-12 – UML Diagram of APD Address Data Types	41
Figure 3-13 – Example: Locality Hierarchy	43
Figure 3-14 – UML Diagram of primary NaPTAN elements	47
Figure 3-15 – UML Diagram of NaPTAN Model: Overview	49
Figure 3-16 – UML Diagram of NaPTAN Model: Detail	50
Figure 3-17 – UML Diagram of NaPTAN Stop Types	52
Figure 3-18 – UML Diagram of NaPTAN Off-Street Stop Point Types	54
Figure 3-19 – UML Diagram of NaPTAN On-Street Stop Point Types	55
Figure 3-20 – UML Diagram of NaPTAN StopAccessibility	56
Figure 3-21 – UML Diagram of NaPTAN TariffZones - Overview	57
Figure 3-22 – UML Diagram of NaPTAN TariffZones - Details	57
Figure 3-23 – UML Diagram of NaPTAN PointOfInterest - Overview	58
Figure 3-24 – UML Diagram of NaPTAN PointOfInterest - Details	59
Figure 3-25 – UML Diagram of NaPTAN Stop Hierarchy	60
Figure 3-26 – UML Diagram of NaPTAN TariffZone Hierarchy	60
Figure 3-27 – UML Diagram of NaPTAN PointOfInterest Hierarchy	61
Figure 3-28 – UML Diagram of NaPTAN Data types	62
Figure 3-29 – Example of Stop Names in a List	75
Figure 3-30 – Example of Ambiguous Place Names	75
Figure 3-31 – UML Diagram of Discovery Model: Overview	80
Figure 3-32 – UML Diagram of Discovery Model: Detail	81
Figure 3-33 – UML Diagram of Coverage Model	82
Figure 3-34 – UML Diagram of NPTG Discovery Hierarchy	83
Figure 5-1 – NPTG Schema Overview	87
Figure 5-3 – Region Element	88
Figure 5-4 – AdministrativeArea Element	90
Figure 5-5 – NptgLocality Element	92
Figure 5-6 – Locality / Descriptor Element	93

Figure 5-7 – NptgDistrict Element	93
Figure 5-8 – PlusbusZone Element	94
Figure 6-1 – UML Diagram of NaPTAN Schema	95
Figure 6-2 – NaPTAN Root Element	96
Figure 6-3 – StopPoint Element	97
Figure 6-4 – StopIdentifierGroup Group	98
Figure 6-5 – SiteDescriptionGroup Group	99
Figure 6-6 – Descriptor Element	100
Figure 6-7 – Place Element	101
Figure 6-8 – StopReferencesGroup Group	102
Figure 6-9 – StopFurtherDetailsGroup Group	102
Figure 6-10 – StopClassification Element	104
Figure 6-11 – OnStreet / Bus Element	105
Figure 6-12 – OnStreet / Bus / MarkedPoint Element	106
Figure 6-13 – OnStreet / Bus / UnmarkedPoint Element	106
Figure 6-14 – OnStreet / Bus / HailAndRideSection Element	106
Figure 6-15 – OnStreet / Bus / FlexibleZone Element	107
Figure 6-16 – OnStreet / Taxi Element	107
Figure 6-17 – OnStreet / Taxi Element	107
Figure 6-18 – OffStreet / Air Element	108
Figure 6-19 – OffStreet / Ferry Element	109
Figure 6-20 – RailExchange Element	110
Figure 6-21 – OffStreet / Metro Element	111
Figure 6-22 – OffStreet / Coach Element	112
Figure 6-23 – OffStreet / Telecabine Element	113
Figure 6-24 – Stop Availability Element	114
Figure 6-25 – StopAccessibility Element	114
Figure 6-26 – SiteAccessibilityGroup Group	116
Figure 6-27 – StopAccessibilityGroup Group	117
Figure 6-28 – AccessVehicle Element	118
Figure 6-29 – DayType Element	119
Figure 6-30 – BankHolidays Element	120
Figure 6-31 – StopArea Element	122
Figure 6-32 – Network Element	123
Figure 6-33 – TariffZone Element	123
Figure 6-34 – PointOfInterest Element	124
Figure 6-35 – PointOfInterestClassification Element	125
Figure 7-1 – UML Diagram of the NPTG Discovery Schema	127
Figure 7-2 – NptgDiscovery Root Element	128
Figure 7-3 – WebApplication Element	129
Figure 7-4 – UsedBy Element	130
Figure 7-5 – TrustedServer Element	130
Figure 7-6 – AdjacentRegionPoint Element	131
Figure 7-7 – CallCentre Element	132
Figure 7-8 – CallCentre / Availability Element	133
Figure 7-9 – DayTypes Element	133
Figure 7-10 – HolidayTypes Element	135
Figure 7-11 – OpeningHours Element	136
Figure 7-12 – PrimaryTelephoneNumber Element	136
Figure 7-13 – TrunkLocality Element	137
Figure 8-1 – Location Element	138
Figure 8-2 – Translation Element	139
Figure 8-3 – Bearing Element	139
Figure 9-1 – Example 1: Poles Both Sides of the Road with One Landmark	141

Figure 9-2 – Example 1: Stop Hierarchy for Cosham Health Centre.....	141
Figure 9-3 – Example 2: Poles Both Sides with Different Common Names.....	143
Figure 9-4 – Example 2: Street Names in Central Cosham.....	144
Figure 9-5 – Example 2: Stop Hierarchy for Cosham Fire & Police Stations	144
Figure 9-6 – Example 3: Pole, One Side Only with Landmark	146
Figure 9-7 – Example 3: Blacko Village map.....	147
Figure 9-8 – Example 3: Stop Hierarchy for Blacko Rising Sun	147
Figure 9-9 – Example 4: Bus Stop on One Side of a Road with No Landmark.....	149
Figure 9-10 – Example 4: Stop Hierarchy for Tilmore Gardens.....	149
Figure 9-11 – Example 5: Bus Interchange	151
Figure 9-12 – Example 5: Stop Hierarchy for Brighton Old Steine	152
Figure 9-13 – Example 6: Hail & Ride.....	153
Figure 9-14 – Example 6: Stop Hierarchy for Newhaven Hail & Ride	153
Figure 9-15 – Example 7: Flexible Zones	155
Figure 9-16 – Example 5: Stop Hierarchy for Lincoln Flexible Service	156
Figure 9-17 – Example 8: Railway Station Interchange.....	158
Figure 9-18 – Example 9: Stop Hierarchy for Farnham Station.....	159
Figure 9-19 – Example 9: Bank Tube Lines.....	164
Figure 9-20 – Example 9: Bank Station Street Area.....	164
Figure 9-21 – Example 9: Stop Hierarchy for Bank Underground Station	166
Figure 9-22 – Example 9: Bank Underground Station – Stops in Area	166
Figure 9-23 – Example 10: Aylesbury Bus Station	169
Figure 9-24 – Example 10: Stop Hierarchy for Aylesbury Bus Station	170
Figure 9-25 – Example 11a: Partial Stop Hierarchy for Heathrow Airport Terminals 123	174
Figure 9-26 – Example 11b: Partial Stop Hierarchy for Heathrow Terminal 4.....	175
Figure 11-1 – UML Model of Element Versions.....	181
Figure 11-2 – <i>Status</i> element: State Transitions.....	183
Figure 11-3 – <i>Modification</i> element State Transitions	183
Figure 11-4 – StopValidity State Transitions.....	184
Figure 11-5 – NPTG Packages.....	189
Figure 11-6 – NPTG Models	189
Figure 11-7 – NPTG Discovery Packages	190
Figure 11-8 – NPTG Discovery Models	191
Figure 11-9 – NaPTAN Packages.....	191
Figure 11-10 – NaPTAN Model Dependencies	192
Figure 15-1 – Diagram of National Gazetteer 1.2 CSV Tables.....	209
Figure 15-2 – Diagram of National Gazetteer 2.1 CSV Tables.....	210
Figure 15-3 – Diagram NPTG Discovery CSV 2.1 CSV Tables	211
Figure 15-4 – Diagram of NaPTAN 1.1 CSV Tables	218
Figure 15-5 – Diagram of NaPTAN 2.1 CSV Tables	219

List of Tables

Table 3-1 – Example of Qualified Locality Names.....	43
Table 3-2 – Characters that are invalid in NPTG & NaPTAN Place and Common Names.....	44
Table 3-3 – Characters Not To Be Used in NPTG & NaPTAN Place and Common Names.....	44
Table 3-4 – English Locality Names without any Preposition that are Hyphenated	45
Table 3-5 – Hyphenation of Prepositions & Articles in NPTG Locality Names.....	45
Table 3-6 – Combining Stop Point & Stop Area Classifications	53
Table 3-7 – Rules for SMS codes	66
Table 3-8 – Precedence of StopArea Types.....	67
Table 3-9 – Examples of Preferred Stop Names	68
Table 3-10 – Example Preferred Form for Rail Station Names	69

Table 3-11 – Example Name Elements	69
Table 3-12 – Ways of Deriving Names from Descriptors.....	69
Table 3-13 – Preferred Phrases to Use in Indicator	72
Table 3-14 – Stop Point Location Types.....	74
Table 3-15 – Populating on-street stops.....	77
Table 3-16 – Populating off-street stops.....	78
Table 3-17 – Main Entities of the NPTG & NaPTAN Models.....	84
Table 5-1 – Allowed Values for Country	88
Table 5-2 – Allowed Values for <i>SourceLocalityType</i>	91
Table 5-3 – Allowed Values for <i>LocalityClassification</i>	91
Table 5-4 – Allowed Values for Plusbus zones	93
Table 6-1 – Allowed Values for <i>StopType</i>	103
Table 6-2 – Allowed Values for <i>BusStopType</i>	104
Table 6-3 – Allowed Values for <i>TimingStatus</i>	105
Table 6-4 – Allowed Values for <i>LimitationStatus</i>	115
Table 6-5 – Accessibility defaults by mode.....	115
Table 6-6 – Allowed Values for <i>AssistanceServiceAvailability</i>	115
Table 6-7 – Allowed Values for <i>MobilityNeed</i>	117
Table 6-8 – Allowed Values for <i>AssistanceNeeded</i>	117
Table 6-9 – Allowed Values for <i>AssistedBoardingLocation</i>	118
Table 6-10 – Allowed Values for <i>StopArea</i> Classification.....	121
Table 7-1 – Allowed Values for <i>WebApplicationClassification</i>	128
Table 8-1 – Allowed Values for <i>StopPoint / Descriptor / Bearing</i>	139
Table 9-1 – Example 10: Stop Notes for Aylesbury Bus Station	170
Table 10-1 – NaPTAN Attributes	178
Table 11-1 – NPTG and NaPTAN Document Version Attributes.....	180
Table 11-2 – Entity Change Tracking & Status Attributes	182
Table 11-3 – Tracked Data Elements	185
Table 11-4 – Change Attribute Groups	185
Table 11-5 – Data Element Change Versioning Principles.....	187
Table 11-6 – NaPTAN 2.0 Module Names	193
Table 12-1 – Comparison of Key Transmodel Terms.....	194
Table 13-1 – Elements That May Contain Natural Language Free Text	196
Table 14-1 – Severity Codes for Semantic Integrity Rules	197
Table 14-2 – NPTG Syntactic Integrity Rules	198
Table 14-3 – NPTG Semantic Integrity Rules.....	198
Table 14-4 – NPTG Discovery Syntactic Integrity Rules	198
Table 14-5 – NPTG Discovery Semantic Integrity Rules.....	199
Table 14-6 – NaPTAN Syntactic Integrity Rules	200
Table 14-7 – NaPTAN Semantic Integrity Rules.....	201
Table 15-1 – NPTG CSV files	212
Table 15-2 – NPTG: Region.csv Content	212
Table 15-3 – NPTG: Admin.csv Content.....	212
Table 15-4 – NPTG: District.csv Content.....	213
Table 15-5 – NPTG: Localities.csv Content.....	213
Table 15-6 – NPTG: <i>LocalityAlternativeNames</i> .csv Content	213
Table 15-7 – NPTG: <i>LocalityHierarchy</i> .csv Content	214
Table 15-8 – NPTG: <i>AdjacentLocalities</i> .csv Content.....	214
Table 15-9 – NPTG: <i>PlusbusZones</i> .csv Content	214
Table 15-10 – NPTG: <i>PlusbusMappings</i> .csv Content	214
Table 15-11 – NPTG: <i>AdjacentRegionPoints</i> .csv Content	215
Table 15-12 – NPTG: <i>CallCentres</i> .csv Content	215
Table 15-13 – NPTG: <i>CallCentres</i> .csv Content	215
Table 15-14 – NPTG: <i>TrustedServer</i> .csv Content.....	216

Table 15-15 – NPTG: WebApplications.csv Content	216
Table 15-16 – NPTG: WebAppCapabilities.csv Content	216
Table 15-17 – NPTG: RegionApplications.csv Content	216
Table 15-18 – NPTG: AdminAreaApplications.csv Content	216
Table 15-19 – NPTG: LocalityApplications.csv Content	217
Table 15-20 – NPTG: StopPointApplications.csv Content	217
Table 15-21 – NaPTAN CSV files	220
Table 15-22 – NaPTAN: Stops.csv Content	221
Table 15-23 – NaPTAN: HailRide.csv Content	221
Table 15-24 – NaPTAN: Flexible.csv Content	221
Table 15-25 – NaPTAN: AlternativeDescriptor.csv Content	222
Table 15-26 – NaPTAN: StopLocalities.csv Content	222
Table 15-27 – NaPTAN: StopAvailabilities.csv Content	222
Table 15-28 – NaPTAN: StopsInStopArea.csv Content	222
Table 15-29 – NaPTAN: AirReferences.csv Content	223
Table 15-30 – NaPTAN: RailReferences.csv Content	223
Table 15-31 – NaPTAN: FerryReferences.csv Content	223
Table 15-32 – NaPTAN: MetroReferences.csv Content	224
Table 15-33 – NaPTAN: CoachReferences.csv Content	224
Table 15-34 – NaPTAN: LocalityMainAccessPoints.csv Content	224
Table 15-35 – NaPTAN: StopPlusBusZones.csv Content	224
Table 15-36 – NaPTAN: StopAreas.csv Content	225
Table 15-37 – NaPTAN: StopAreaHierarchy.csv Content	225
Table 15-38 – Common NPTG and NaPTAN CSV Data Types	226

1 INTRODUCTION

The National Public Transport Access Nodes (*NaPTAN*) database is a UK nationwide system for uniquely identifying all the points of access to public transport in the UK. *NaPTAN* seeks to provide a comprehensive data set of all of the stopping places used by public transport services.

The National Public Transport Gazetteer (*NPTG*) provides a topographic database of towns and settlements in the UK, and is used by the *NaPTAN* dataset to associate Public Transport Access Nodes (PTANS) with localities.

NPTG and *NaPTAN* together enable computerised public transport information systems to provide stop finding and referencing capabilities using consistent, meaningful names for places and stops. The points of the *NaPTAN* system provide a coherent national framework of reference for integrating all kinds of public transport data including journey planning and real-time information.

Both *NaPTAN* and the *NPTG* can be exchanged as XML documents; this document is a guide to the *NaPTAN* and *NPTG* XML schemas which describe those documents. The schemas are available at a website at <http://www.naptan.org.uk>, which also provides additional information and resources.

This is a revised version of the Schema Guide covering *NaPTAN* & *NPTG* 2.5, released in 2013 to coincide with release 2.5 of TransXChange. For a summary of modifications see Section 1.9.6 below.

1.1 NPTG Components

The *NPTG* consists of the following elements:

1. A standard set of names for UK places and settlements, together with a method for assigning topographic names so as to be suitable for journey planning and other computer based information services.
2. A division of the UK into administrative areas to manage public transport access node and other data, and the identification of services supporting it.
3. A pair of XML Schemas for describing the *NPTG* & *NPTG Discovery* data when it is exchanged as XML documents.
4. An alternative exchange format for exchanging *NPTG* data as CSV files.
5. A database of all the settlements in the UK, compiled to the standard that can be exported into the prescribed formats.

1.2 NaPTAN Components

NaPTAN consists of the following elements:

1. A standard method for identifying and describing access points to public transport.
2. An XML Schema for describing the *NaPTAN* data when it is exchanged as XML documents.
3. An alternative exchange format for exchanging stop data as CSV files.
4. A process for gathering information about changes to stop data and compiling it into the central database.
5. A database of all the access points in the UK, compiled to the standard that can be exported into the prescribed formats.

The *NaPTAN* database is maintained centrally under contract to the Department for Transport.

1.3 NPTG and NaPTAN Users

NPTG and *NaPTAN* data users include:

- Traveline – the National Passenger Transport Information System.

- Transport Direct Portal.
- Bus Service Operators.
- Traffic Area Offices.
- Local Authorities.
- Passenger Transport Executives.
- Scheduling System Suppliers.
- Journey Planning System Suppliers.
- Real Time Information Systems Suppliers.
- Electronic Fare management systems and Smartcards (ITSO)
- Mapping and Map-information Information System Suppliers.
- Point of interest databases.
- Tourism Industry.
- Estate Agents.

The *NaPTAN* stop database is fundamental for *TransXChange*, the UK system for recording schedules as XML documents for electronic registration of bus services.

NaPTAN is also fundamental to *JourneyWeb*, the UK national distributed journey planning protocol. Note that the appropriate naming of localities and stops is an important consideration for providing effective place and stop finding in on-line journey planners, and some guidance on this subject is included in this document.

1.4 Motivation

This *NPTG and NaPTAN XML Schema Guide* is intended to provide a technical overview and reference manual to the *NPTG and NaPTAN* Schemas for system developers, data providers and other users of *NaPTAN* and the *NPTG*.

It includes guidelines on the naming of stops and stop areas so that data is effectively labelled for use in journey planning engines. The guide provides, in particular, a description of the *NaPTAN* and *NPTG* XML schemas, both of which are encoded as W3C XML xsd schemas. Note that detailed documentation of individual schema elements is provided as annotations within the schemas. Software tools such as XML SPY can be used to explore the structure and details of the schema.

1.5 Antecedents

Version 1.0 of *NaPTAN* was originally developed by WSAtkins for Transport Direct under contract to the UK Department for Transport. It built on earlier stop numbering systems used by the Association of Transport Coordinating Officers (ATCO).

A subsequent update 1.1 in October 2003, also managed by WSAtkins, comprised a revision to the coding of stations to simplify the use of *NaPTAN* codes by journey planners.

NaPTAN version 2.0, a revision in 2004 of the standard, managed by Carl Bro with technical development by Kizoom, had as its main functional change the harmonisation of *NaPTAN* with other public transport schemas and government standards for XML schemas. *NaPTAN* 2.0 included a new documentation set, including this guide, drawing on the *NaPTAN* specification v1.0 produced by WSAtkins on behalf of the Department for Transport (see 15.3), and the '*Creation of National Public Transport Gazetteer (NPTG) Guidance Notes – Version 6 (1 June 2002)*'. A slightly revised version of the 1.1 schema was introduced as 1.3 to ease migration to 2.0. The term '1.x' is used to refer collectively to the 1.0 and other prior versions

NaPTAN version 2.1 was a very minor update to version 2.0 to relax the requirement to provide **Landmark** and **Street** elements for all descriptors. 2.1 should be fully backwards compatible with 2.1 in all other respects. It is accompanied by a 1.4 version of the earlier 1.x schema.

NaPTAN version 2.2 was a minor update to version 2.1 to add an archive status for element change management. V2.2 should be fully backwards compatible with 2.1 in all other respects. Version 2.3 added a new stop type for bus/coach stops in private locations.

NaPTAN & *NPTG* version 2.4 was a minor update to version 2.2 to add some stop type and relax some constraints on certain data types and support for private stops. It coincided with release 2.4 of *TransXChange*. It was also internally restructured into smaller component packages to facilitate maintenance and correspondence with *Transmodel/NeTEx*.

NaPTAN & *NPTG* version 2.5 is a minor update to version 2.4 to add support for *Eire* stops, fare zones and some basic accessibility tagging. It coincides with release 2.5 of *TransXChange*. V2.5 of *NaPTAN* & *NPTG* are fully backwards compatible with 2.4. For the London 2012 Olympics *JourneyWeb* was enhanced to allow planning to venues and other points of interest. *NaPTAN* 2.5 also includes elements to show how *NaPTAN* point identifiers can be used to describe sites other than stop points. Note however that point of interest data is not supplied.

The term '2.x' is used to refer collectively to the 2.0, 2.1, 2.2, 2.3, 2.4 and 2.5 versions.

The *NPTG* and *NaPTAN* 2.x XML schemas reference common *GovTalk* XML type definitions, in particular those shared by other UK Public Transport XML schema that use *NaPTAN*, such as *JourneyWeb* and *TransXChange*.

1.6 Document Structure

The *NPTG* and *NaPTAN* Schema Guide is organised as follows:

Part I – Overview.

The chapters in Part I are intended to give a summary of the basic concepts and purpose of *NPTG* and *NaPTAN*.

- *NPTG* and *NaPTAN* Overview.
- *NPTG* and *NaPTAN* Models.

Part II – Schema Elements

The chapters in Part II provide a detailed account of the schema elements:

- *NPTG* Schema.
- *NaPTAN* Schema.

Part III – *NPTG* and *NaPTAN* Examples

The chapters in Part III provide some examples for creating correct *NaPTAN* stop definitions.

Part IV – Technical Annexes

The chapters in Part IV provide technical details on various aspects of *NPTG* and *NaPTAN* documents and technology.

- Technical Annexes.
 - Versioning.
 - National Language Support.
- Reference Appendixes.
- Reference Annexes.
 - *NaPTAN* CSV exchange format.

1.7 Intellectual Property Rights

1.7.1 *NPTG and NaPTAN* Schema

The *NPTG and NaPTAN* Schemas are Crown Copyright, managed by the UK Department for Transport. The schemas may be used without charge.

The *NPTG and NaPTAN* Schemas may reference other Schemas that are also Crown Copyright, or that are owned by Associate Members of the UK Government GovTalk initiative.

Anyone who wishes to reproduce the Schemas in any format must acknowledge the source and state that the Schemas are the copyright of the named Associate Member or Crown Copyright, as appropriate. The permission to reproduce does not extend to any Schema or parts of Schema which are specifically identified as being the copyright of anyone who is not a Member or Associate Member. Permission to reproduce these Schema or parts of these Schemas must be obtained from the identified copyright holders.

The designated owner of the *NPTG and NaPTAN* schemas for GovTalk is:

NaPTAN, Transport Direct Team,
Department for Transport,
2/17 Great Minster House
33 Horseferry Road
London, SW1P 4DR

1.7.2 *NPTG* Database

Rights in the *NPTG* database are separate from rights in the *NPTG* Schema.

The *NPTG* Database is Crown Copyright. Use of the *NPTG* data is free, but subject to UK Open Government Licence (OGL). <http://www.nationalarchives.gov.uk/doc/open-government-licence/>

1.7.3 *NaPTAN* Database

Rights in the *NaPTAN* database are separate from rights in the *NaPTAN* Schema.

The *NaPTAN* Database is Crown Copyright. Use of the *NaPTAN* data is free, but subject to UK Open Government Licence (OGL). <http://www.nationalarchives.gov.uk/doc/open-government-licence/>

Anyone who wishes to use the *NaPTAN* data must acknowledge the source and state that the data is Crown Copyright in accordance with the licence conditions.

1.8 Versioning

A strict versioning system is used for the *NPTG and NaPTAN* schemas, following e-Gif principles. This has been made explicit since Version 2.0 of *NaPTAN*, and is explained in Section 11.1.

1.9 Changes in Releases

The primary objective of release 2.0 of *NaPTAN* was to systemise the XML schema and model so as to facilitate the interoperability of *NPTG* and *NaPTAN* with other UK standards.

1.9.1 Standardisation 2.0

Harmonising changes included:

- Adding coverage of *NPTG* entities in an additional, interoperating XML schema.
- Harmonising with NaPT types and with GovTalk standard types.
- Applying e-GIF and XML best practice principles.
- Support for WGS84 coordinates.
- Systemising National Language support.
- Harmonising entity modification version numbers and timestamps.
- Adding support for flexible zone stops.

1.9.2 Functional Enhancements 2.0

In addition a number of changes were included to address issues arising from experience with version 1.1. These included:

- Introduction of explicit name qualifiers so that locality and stop names can be made unique as required within different scopes. A short name to use as a qualifier was added to administrative area.
- An explicit relationship between NPTG district and administrative area.
- Restrictions on the allowed character set for name elements.
- Further guidance on naming styles so as to obtain unique names.
- Addition of an explicit delete pending status.
- Addition of a short common name to stop point, with maximum length set by administrative area.
- Extension of alternative stop name element to become an alternative descriptor element that includes indicator, street and landmark.
- Addition of an availability element including both validity periods for stops, and a transfer relationship to allow for the moving of stops.
- Separation of concept of locality centre and main or central stop for locality.
- Addition of an optional adjacency relationship for localities.

1.9.3 Name Changes in Release 2.0

One of the consequences of harmonisation was that a number of fundamental *NaPTAN* elements are renamed to bring them in line with *Transmodel* and/or the other UK Public Transport schemas.

We summarise the main name changes here:

	Name v1.1	Name in v2.0
NPTG, NaPTAN	Area	AdministrativeArea
NPTG, NaPTAN	NatGaz /Id	NptgLocalityCode
NaPTAN	Stop	StopPoint
NaPTAN	StopGroup	StopArea
NaPTAN	ATCOCode	AtcoCode
NaPTAN	SMSNumber	NaptanCode
NaPTAN	Direction	Bearing
NaPTAN	BusStopType	StopClassification/Bus/
NaPTAN	BusRegistrationStatus	TimingStatus
NPTG	ExchangePointGroup	MainPoint
NPTG	AirExchangePoint	AnnotatedAirRef
NPTG	CoachExchangePoint	AnnotatedCoachRef
NPTG	RailExchangePoint	AnnotatedRailRef
NPTG Discovery	AREP	AdjacentRegionPoint

Figure 1-1 – Name changes in NaPTAN 2.0

1.9.4 Changes in Release 2.1

- In release 2.1 the **Landmark** and **Street** elements were made optional.
- **AnnotatedCoachRef** was added to all types of on street bus and coach stop.
- **AnnotatedCoachRef** may also include an operator code.

1.9.5 Changes in Release 2.2

- Allowed an additional "archived" status.
- - [NPTG Discovery] Added **TrunkLocality**.
- - [NPTG Discovery] Corrected version No.

1.9.6 Changes in Release 2.3

- Diagrams revised and more detail added.
- NaPT_stop-V2.1 added new Public flag on stops (replacing previous proposition for a BCP stop type).

1.9.7 Changes in Release 2.4

Changes in 2.4 are limited to syntactic changes. No database changes are required.

- Functional
 - PTIC-008 NaPT_stop-v2.4 Constraints on NPTG NaPTAN code AlphaPrefix relaxed to allow 1 for London and to relax constraints on codes for use in London and Yorkshire.
 - NaPT_types-v2.1 Constraints on PrivateCode relaxed from NMTOKEN to string.
 - PTIC-075 NPTG updates: Add Northern Ireland & Eire to country enumerations. NPTG Discovery: Support multiple regions per call centre. Add SIRI & other service types.
 - Stop types added for Cable Lifts & Car setDown to enable London 2012 Olympics.
- Technical
 - All UML diagrams converted to EA format and revised, Correction to the data.
 - All XML diagrams updated to show types.
 - All Example diagrams corrected and updated.
 - Internally restructuring to small modular packages corresponding to the Transmodel / NeTeX structure. This facilitates mapping between standards and further evolution of NaPTAN. Should not have an effect on the resulting aggregated document.

1.9.8 Changes in Release 2.5

- Functional
 - PTIC-083 Support for Eire locations:
 - ITM (Irish Transverse Mercator) allowed as grid type.
 - Multiple Grid translations allowed.
 - PTIC-087 Accessible Booking info added
 - PTIC-086 StopAccessibility added to StopPoint.
 - PTIC-088 Basic Tariff Zones added. Sufficient to tag stops with the Zones for which they are eligible.
 - Add Location to AnnotatedAirRef for consistency.
 - PTIC086 Alignment with JourneyWeb. Venue types added with PointOfInterest. This also serves to clarify the general modelling of sites and to support accessibility.
- Technical.
 - The version number attribute on a NaPTAN document was previously a fixed value (e.g. 2.1, 2.4, etc). It is now a variable that defaults to the current value (e.g. 2.5). This makes it easier for implementers to use a single schema binding with documents that conform to earlier releases.

1.10 Content Not Covered by NaPTAN

NaPTAN focuses on PTAN information and does not currently cover interchange times, or interchange paths. This can be exchanged using the CEN NeTeX schema, into which NaPTAN data can be mapped.

1.11 Naming Conventions

Systematic Naming conventions are used for schema elements. These are described in Section 11.

1.12 Presentation Conventions

Consistent conventions are used throughout this Guide to present software artefacts.

1.12.1 XML Elements in Text

NaPTAN and *NPTG* use the XML Schema Language (See <http://www.w3.org/TR/xmlschema-0/>, <http://www.w3.org/TR/xmlschema-1/> and <http://www.w3.org/TR/xmlschema-2/>), and its terminology, such as “element”, “attribute”, “sequence” and “choice” to formally describe its data structures.

Throughout this *NPTG and NaPTAN* Schema Guide:

- XML elements are shown in bold italic type, for example the ***StopPoint*** element.
- XML attributes are shown in bold, for example **MappingSystem**.
- Containment of a subelement by another element is shown by a forward slash, for example ***StopPoint / AtcoCode***.

1.12.2 UML Diagrams

Unified Modelling Language (UML) notation is used for class and instance diagrams to show the formal structure of the *NPTG and NaPTAN* conceptual models; the diagrams express structure in terms of classes, connected by association, aggregation and inheritance relationships, corresponding to the semantics available in XML’s built-in reference and extension mechanisms.

UML notation uses well known conventions for showing the navigability, multiplicity, and optionality of model elements and relationships.

For *NPTG and NaPTAN*, we refine the standard UML conventions by the systematic use of colour, in particular:

- Network topology elements are shown in diagrams in *green* (for example, ***StopPoint***, ***StopArea***).
- Administrative related elements are shown in *pink* (for example, ***AdministrativeArea***, ***Region***).
- Topographical elements are shown in *olive*, for example (for example, ***NptgLocality***, ***NptgDistrict***).

Different levels of detail are shown in the UML diagrams; introductory diagrams omit details and provide a high level overview; model diagrams show detailed attributes including physical attributes used to implement relationships; hierarchical views show the supertypes of objects; supporting diagrams show the low level data types used in the model diagrams.

Since we are depicting a physical model, in detailed diagrams we also indicate the attributes used to implement relationships.

1.12.3 XML Structure Diagrams

XML Spy (from Altova GmbH) structure diagrams are used extensively in the detailed schema description to illustrate the containment structure of XML schema fragments. Each XML element is shown as a solid box. Use of a complex data type is shown by a dashed box.

The presence of attributes is indicated by a ‘+’. Since a common set of metadata attributes is used for first class objects, we do not generally show the attributes, though they may be listed in the accompanying documentation, using a convention of including the attribute name in the element comment prefixed by an ‘at’ sign (‘@’), for example ‘@lang’.

1.12.3.1 Element Structure – Sequence

The hexagonal symbol with the horizontal line of three dots indicates “sequence of.” For example, *Figure 1-2* says the element ***ValidityPeriod*** consists of the sequence of ***StartTime*** followed by ***EndTime***. Both elements are defined in the namespace whose prefix is “*txc*”. The adornment of a

small series of horizontal lines in their upper left box corners indicates that **StartTime** and **EndTime** have a simple type. Types are normally shown in the bottom half of the box.

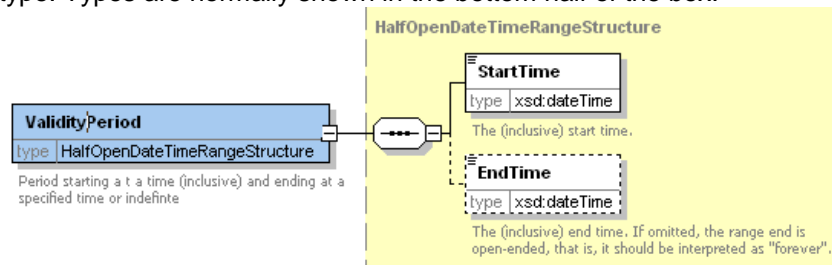

Figure 1-2 – XML Spy Diagram: Sequence

1.12.3.2 Element Structure – Choice

The hexagonal symbol with the switch-like icon indicates a choice. For example in *Figure 1-3* there is a choice between the elements **NoSubsidy**, and **Subsidy**. **Subsidy** has a further substructure, indicated by a "+" in at the right-hand end. **NoSubsidy** is simple type.

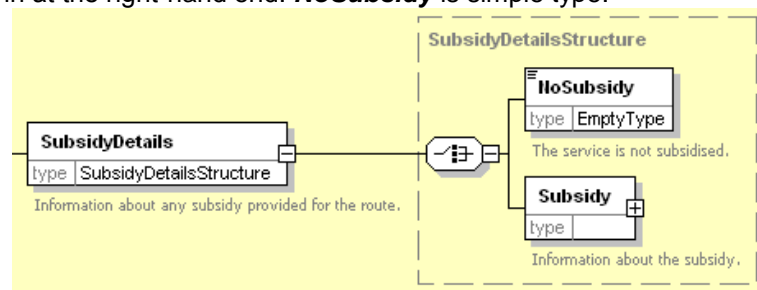

Figure 1-3 – XML Spy Diagram: Choice

1.12.3.3 Multiplicity and Optionality

Whether elements are required or optional, and the multiplicity (cardinality) of elements is indicated by adornments as follows:

- A *fine dashed line* on the connecting line and surrounding box indicates an element is optional. For example, in *Figure 1-4*; **FlexibleZones** and **Description**.
- A *solid line* indicates a mandatory element. For example, in *Figure 1-4*; **StopPointRef**.
- A *number adornment* indicates a multiplicity other than one. 'Many' is indicated by an infinity sign ∞ . Thus, for example in *Figure 1-4*, there may be zero or one **Activity instances** per **StopUsage**, but there can be between one and many **StopUsages** per **FlexibleZone**.

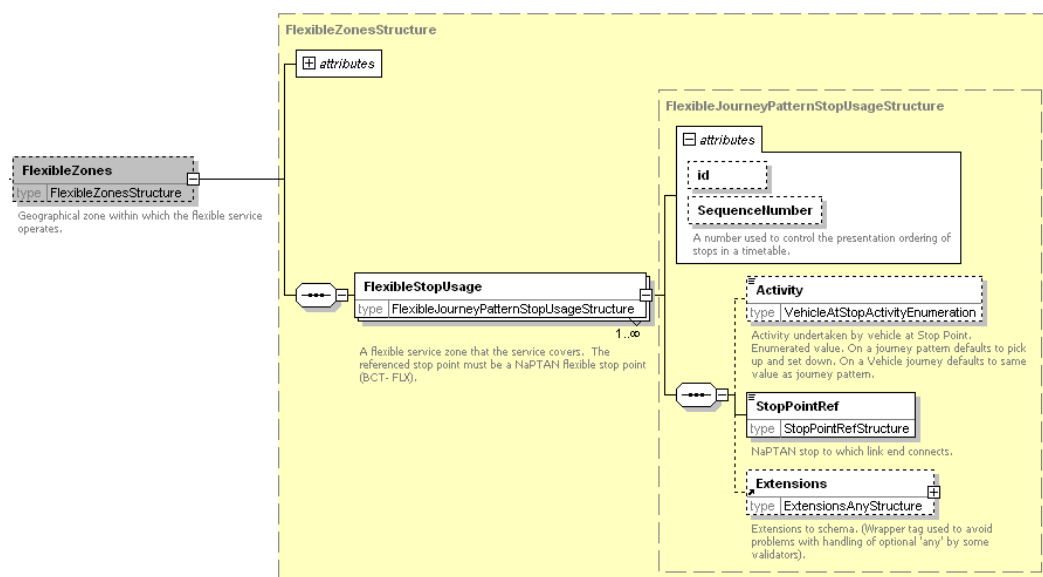

Figure 1-4 – XML Spy Diagram: Multiplicity

1.13 Related Transport Information Standards

NPTG and *NaPTAN* are XML based standards and are compatible with the following standards for public transport information:

- **ATCO-CIF: (UK)** ATCO-CIF is a general purpose interchange format for common elements of timetable information. *NaPTAN* is an evolution of the stop identification system from ATCO.
- **TransXChange: (UK)** *TransXChange* is a UK national data standard for the interchange of bus route and timetable information, intended as a successor to ATCO-CIF. The standard is sponsored by the UK Department for Transport, and is mandated by the Traffic Area Network (TAN) for the electronic registration of UK bus services with Traffic Area Offices (TAO) within the Vehicle and Operator Services Agency (VOSA), and Local Authorities. *TransXChange* 2.x is harmonised with *NaPTAN* 2.x.
- **Transmodel: (CEN)** *Transmodel* is an abstract reference model of the data of interest to organisations providing transport related information systems. It has resulted from several European Commission sponsored projects. *NaPTAN* can be related to Transmodel concepts and terminology for stops. Since the development of *NaPTAN* Transmodel has been further evolved by the addition of a detailed stop model IFOPT (Identification of Fixed Objects) drawing on *NaPTAN* and the experience of other European nations.
- **NeTEx: (CEN)** *Network Exchange* is a reference model and XML schema for exchanging network, timetable and fare data for public transport information systems, developed from Transmodel and IFOPT. It includes a stop place model and administrative model derived from *NaPTAN* and *NPTG*. It provides design input for many further aspects of public transport. *NaPTAN* data can be mapped into a NeTEx schema and augmented. Enhancements to *NaPTAN* are usually done in a manner intended to be compatible with NeTEx.
- **JourneyWeb: (UK)** *JourneyWeb* is an XML protocol allowing distributed journey planning. The protocol is a UK national *de facto* standard sponsored by the UK Department for Transport and is being used in the Transport Direct Portal to provide contiguous distributed journey planning across the whole of Great Britain.

- **SIRI:** (CEN) The *Service Interface for Real-time Information* is a standard for the exchange of real time bus information between systems which was developed by TC278 WG3 of CEN with UK participation sponsored by the DfT, originally through the UK Real Time Interest Group, and now PTIC. SIRI services that reference stops, such as the SIRI Stop Monitoring Service (SIRI-SM), can reference NaPTAN stop points.
- **UK Geocoding** References: For geospatial references the *NaPTAN* data set hold OSGR Grid references – the Easting and Northing, with support for both UK Mainland and Irish grids. In release 2.x the schema supports the exchange of WGS84 coordinates as an alternative. For release 2.5 ITM (Irish Transverse Mercator) grid is also supported.

1.14 Acknowledgments

The original Schema Guide for version 2.0 of NaPTAN was prepared by the Kizoom (Nick Knowles, Tom White) and Carlbro (Richard Mejia, Paul Robinson) teams under direction of Roger Slevin of the Department for Transport. It included revised examples and appendixes from the original *NaPTAN* specification prepared by WSAtkins, and examples from '*Modelling stops – Usage of NPTG and NaPTAN in the South East Enquiry Management System*', a paper produced by MDV gmbh. Schema, introduction, modelling and technical sections were provided by Kizoom. We thank Dr Hans-Joachim Mentz of MDV for his examples, comments and material on stop naming. Thanks also to John Gallagher (Thales), Dean Garraghty (Trandata), Kieren Holmes (Cap Gemini), Paul Houghton (Trandata), Peter Miller (ACIS), Mike Ness (WSAtkins), John Prince (SYPTe), Richard Shaw (WSAtkins), Dr Martin Siczkowski (WYPTE), Roger Dennis (Trapsoft) and other ATCO and RTIG members for their comments, corrections and other feedback.

Version 2.1 of NaPTAN accompanied version 2.1 of *TransXChange* and was prepared to by the Kizoom (Nick Knowles, Tom White) and Carlbro (Richard Mejia, Paul Robinson) teams under direction of Roger Slevin of the Department for Transport.

Version 2.4 accompanied version 2.4 of *TransXChange* and was prepared by the Kizoom (Nick Knowles) and Centaur (Mark Cartwright) teams with guidance from Roger Slevin and Chris Gibbard of the Department for Transport.

Version 2.5 accompanied version 2.5 of *TransXChange* and was prepared by Nick Knowles with guidance from Chris Gibbard and Helen Pattington of the Department for Transport. with input from Jonathan Shewell Cooper of ATOS.

2 INTRODUCTION TO NAPTAN AND THE NPTG

2.1 The Purpose of the National Public Transport Gazetteer

NaPTAN depends closely on the *National Public Transport Gazetteer* (NPTG). The *NPTG* provides a model of all UK cities, towns and settlements to which people might wish to travel, or which they might wish to use to describe the places to which they wish to travel. Every *NaPTAN* stop is assigned to a *NPTG* locality. This association has two main purposes:

1. It allows stops to be related to the topographical area in which they lie, so that a wide variety of user search functions can be supported to find travel destinations and travel access points.
2. It allows stops to be related to the computer systems which provide coverage for the stop, for example for journey planning or real time information, so that services can be provisioned automatically.

Not all NPTG localities, however, have stops associated with them. The Gazetteer seeks to present a comprehensive list of UK localities as known to the public, regardless of whether transport services are available within a given locality.

2.1.1 The NPTG Database

The *NPTG* database holds a current data set of all UK towns and settlements, organised within a topographical hierarchy. The *NPTG* database is maintained centrally by Landmark Information Group under contract to the Department for Transport.

2.1.2 The NPTG XML Schemas

NPTG data is described by two related *XML schemas*. (i) The main NPTG Schema, (ii) The NPTG Discovery schema, relating NPTG entities to available services. The schemas can be used to describe *NPTG* data when exchanging it between systems as XML documents. The schemas can be used with software tools to check that documents are correctly formatted and contain the required content.

2.1.3 The NPTG CSV Exchange Format

NPTG data can also be distributed to systems in Comma Separated Variable (CSV) format, as well as XML documents. The *NPTG* CSV exchange format uses a format, recorded in Appendix 15.5.

2.2 The Purpose of NaPTAN

NaPTAN seeks to assemble and maintain a single source of information on the location and naming of bus stops and other public transport access nodes. *NaPTAN* includes the following main elements:

2.2.1 NaPTAN Identifiers

NaPTAN stop point identifiers are a systematic way of identifying all UK points of access to public transport. Stops are submitted by administrative area authorities to a central service which consolidates the stops and distributes them back to users.

- Every UK station, coach terminus, airport, ferry terminal, bus stop, etc is allocated at least one unique *NaPTAN* stop point with its own identifier.
- For large interchanges and termini, *NaPTAN* points identify the entrances from the public thoroughfare – one identifier is distinguished as the main entrance. A second point may be used to designate the ‘transport side’ – airside, berth or platform area.

For every *NaPTAN* stop there are two associated *NaPTAN* identifiers, each unique within the UK:

- The **AtcoCode**: A twelve character *NaPTAN* identifier intended for use in computer systems.
- The **NaptanCode**: A short (seven or eight digit) identifier suitable for displaying on stops and referring to the stop in public facing systems. This has been designed to be suitable for use

in SMS and other delivery channels requiring direct reference to a stop identifier by the public. In most areas it uses a character set optimised for a mobile device keypad.

2.2.2 The NaPTAN Database

The *NaPTAN* database holds a current copy of all UK stops and their descriptions. Stops are submitted by Public Transport Authorities (Metropolitan, County and Unitary) to a central authority which validates and aggregates the stop point data and returns it back to consumer systems. The *NaPTAN* database is maintained centrally by Landmark Information Group under contract to the Department for Transport.

2.2.3 The NaPTAN XML Schema

NaPTAN data is described by a *NaPTAN XML Schema*. The schema can be used to describe *NaPTAN* data when exchanging it between systems as XML documents. The schema describes the content model: not only the elements and Data types, but also the rules for combining them. The schema can be used with software tools to check that documents are correctly formatted and have the required content.

The XML documents themselves can be exchanged by different transport mechanisms, for example, FTP, email or http.

It should be emphasised that the *NPTG and NaPTAN* schemas are a standard format for data exchange, and not a specific software program or a dynamic protocol. *NaPTAN* is intended to enable local and national user communities to build systems that can share information correctly, cheaply and efficiently, but does not prescribe detailed error handling or other data processing details.

2.2.4 The NaPTAN CSV Exchange Format

NaPTAN data can also be distributed to systems in CSV format, as well as XML documents. The *NaPTAN* CSV exchange format uses a format recorded in Appendix 15.8.

2.2.5 NaPTAN Process

Gathering, collating and maintaining a large, volatile data set such as that of UK PTANS requires an agreed workflow and process for a large number of different bodies to work together, in both the public and private sectors. *NaPTAN* includes an overall workflow and tools, with specific organisations being charged with specific roles in the overall process.

NaPTAN also prescribes a set of rules for describing stops when populating the *NaPTAN* textual descriptions elements.

2.3 How are NPTG and NaPTAN used?

The most common use of *NPTG* and *NaPTAN* data – to support the exchange of bus timetables - may involve the exchange of three different data sets:

- Exchange of the *NPTG* Gazetteer data.
- Exchange of the *NaPTAN* stops which reference *NPTG* data.
- Exchange of TransXChange documents which reference *NaPTAN* stops and *NPTG* localities, and which may also contain interim local definitions of *NaPTAN* stops.

A further common use of *NPTG* and *NaPTAN* data is to provide place and stop finding functions in journey planners and other on-line enquiry services.

Typical scenarios for the use of *NPTG* and *NaPTAN* are as follows:

2.3.1 Scenario #1: Compilation and Distribution of *NPTG* Data

1. Compilation

The *NPTG* database has been compiled centrally by the Department for Transport, from the input of local editors who use the on-line *NPTG* editor to submit locality definitions. It is updated and reissued continually to the Transport Authorities and other users as an XML file (and also as csv tables). Some data elements may be added centrally – for example Plusbus Zones. *NPTG* documents must validate against a stated version of the *NPTG* schema. If necessary, the same content could be exported and distributed in multiple versions at different schema version levels at the same time.

2. Distribution

The XML document of the *NPTG* content (& or csv files) are distributed. The documents are available to authorised users to download from Landmark Information Group at <http://www.dft.gov.uk/public-transportdatamanagement>. Users may specify the format (XML or CSV) and the version level (e.g. 1.1 or 2.1) that they wish to download.

3. Use

Each authority or other user imports the *NPTG* document into their system, using the version number to determine the appropriate schema level to use. The import application updates the user's version of the *NPTG* data with the changes in the update. Note that individual entities such as localities have version numbers, so it is possible to hold multiple versions of data for the same entity in a client database if desired.

2.3.2 Scenario #2: Gathering and Distribution of *NaPTAN* Stop Data

1. Data Preparation

The responsible party for preparing *NaPTAN* stop data for a given administrative area prepares an updated version of the stop data for that area. Stop points reference *NPTG* localities.

2. Data Export

The *NaPTAN* stop data set for the whole administrative area is exported as an XML document (formerly as a csv file) following a named version of the *NaPTAN* schema. Each administrative area should only export nodes contained within its administrative area boundaries, ignoring nodes outside its boundaries that are 'owned' by another authority. Only the latest revision of each entity should be exported.

3. Data Transmission

The XML document is sent to the central organisation responsible for concentrating *NaPTAN* data (Landmark Information Group).

4. Data Concentration

The stop data is imported into the *NaPTAN* database, using the schema level indicated in the document to interpret the content. Note that records are never removed from the database, simply flagged as deleted or suspended if out of use. When a replacement set of stops for a whole area is imported, an error report will be produced detailing any nodes that were in the database previously but are not in the imported file. This error report will be sent back to the supplier of the data so that they can discover where the records have gone. The 'lost' nodes will be kept in the *NaPTAN* database with a 'pending' delete **Status**.

5. Data Export

NaPTAN data for the country is exported as an XML document conforming to the *NaPTAN* schema. The data is also available as csv files. There are separate files:

- For the whole country.
- For each administrative area. As of March 2010 there are currently 146 administrative areas (including 5 which are national mode-based areas).

The files are available from Landmark Information Group at <http://www.dft.gov.uk/public-transportdatamanagement/>. Users may specify (i) the area (all or area code(s)), (ii) the format (XML or CSV) and (iii) the version level (e.g. 1.1 or 2.1) that they wish to download.

6. Data Import

Each authority or other user downloads and imports the *NaPTAN* document into their system, using the version number to determine the appropriate schema level to use.

2.3.3 Scenario #3: Exchange of *NaPTAN* Data within *TransXChange*

1. Data Preparation

Users prepare bus schedules including, if necessary, any stop definitions for new *NaPTAN* stop points that are required. An **AtcoCode** is obtained for each new stop from the relevant local Transport Authority.

2. Data Export

The bus schedules are exported as XML documents in *TransXChange* format, and may include (i) local definitions of new *NaPTAN* stop points and stop areas, as well as (ii) references to existing *NaPTAN* stop points and stop areas. The schedules may be published using the *TransXChange* publisher; *NaPTAN* stop names will be used to identify the stops. The *NPTG* Administrative Areas and *NPTG* Localities referenced by any new local stop definitions must exist in the *NPTG*.

3. Data Use

The importing application imports the *TransXChange* documents, and resolves the stops against its *NaPTAN* database. Stops are reconciled according to their *NaPTAN* **AtcoCode** identifiers, and the interim definitions used for any new stops that are not yet defined in the application's current copy of the distributed *NaPTAN* database. For most applications (for example schedule registration with a Traffic Area Office), any reference to an existing stop that is not found in the *NaPTAN* database is an error.

2.3.4 Scenario #4: Using *NPTG* and *NaPTAN* Data in a Place Finder

One of the common uses that a public transport information system, such as a journey planner, will wish to make of data is to provide users with a means to find origin destination places by a variety of different strategies. For example:

- By *NPTG* locality name.
- By *NPTG* locality name &/or transport mode.
- By *NPTG* locality name & *NPTG* sub locality.
- By Map location (or post code).

Journey planning engines will use the *NPTG* and *NaPTAN* data sets to build a place model. It is therefore important to have names that are authoritative and descriptive, and in particular that are comprised of content that can be used to distinguish a target place from other places that are similar in name and/or location. It is also important to geocode stops with their correct spatial location, as well as to annotate PTANs and localities by semantic relationships, so that powerful 'fuzzy' search functions can be provided, and so that the engines can aggregate very similar stops in a locality into a single 'place' within the user interface. The role of *NaPTAN* is to provide data that can be transformed correctly and unambiguously into the different presentations of stop names needed by software user interfaces, but not to prescribe or preclude specific presentation formats. The requirements to fulfil this role are discussed further later on.

2.3.5 Scenario #5: Using NPTG and NaPTAN Data in a Stop Finder

Another common use that public transport information systems, in particular Automatic Vehicle Location (AVL) systems, may wish to make of *NPTG* and *NaPTAN* data is to provide users a means to find stop points by a variety of different strategies. In this case the ability to discriminate every individual stop is important: (as opposed to aggregating a number of stops into a 'place').

- By name, and/or transport mode.
- By name and *NPTG* locality and /or transport mode.
- By *NaPTAN* identifier.
- By *NPTG* locality and /or transport mode.
- By *NPTG* locality and *NPTG* sub locality.
- By address.
- By map location (or post code).

It is therefore important to have stop names that are descriptive, and in particular that distinguish them from similar instances in a locality. The requirements to do this are discussed later.

2.3.6 Scenario #6: Using NaPTAN Data for real-time departures

Stop Identifiers may be used to provide a common reference framework for exchanging data between Automatic Vehicle Location (AVL) systems and web, mobile and sign distribution channels. The stop point identifier can be used to identify individual points.

2.4 Document Validation

To be valid *NPTG* or *NaPTAN* data, XML documents must satisfy two levels of validity criteria:

1. **Well-formedness and validity:** Documents must parse and validate against the *NPTG* or *NaPTAN* schemas, including all the integrity constraints coded within the schema, such as for key uniqueness and reference and for conformance of values to data types. Validation is typically done by the built-in capabilities of standard software tools using the specification provided by the schema and does not require additional programming.
2. **Correctness:** Documents must satisfy additional processing rules and constraints that are not enforceable in the XML of the schema, but which can be applied by an application importing the data. A number of data integrity rules are specified in this document in sections 14.2.2 and 14.3.2., and are also mentioned as annotations in the schema. Typically these rules cover additional complex processing or uniqueness constraints that cannot readily be expressed using XML's built-in mechanisms.

3 SHORT TOUR OF THE NPTG AND NAPTAN REFERENCE MODELS

In this chapter we provide a summary of the physical data models underlying (i) the *NPTG* and (ii) the *NaPTAN* schemas. Both are relatively simple models with a small number of entities.

The physical model is presented as UML diagrams, with different levels of details

- Top level elements
- Detailed elements with attributes

The diagrams are intended to show how relations and composite objects are serialised as XML: the model therefore includes the attributes used to implement relationships by reference and by containment.

3.1 The National Gazetteer Model

Figure 3-1 introduces, in UML class diagram notation, the fundamental elements of the *NPTG* schema. The elements of the *NPTG* model fall into two main groups:

- *Topographical*.
- *Administrative*.

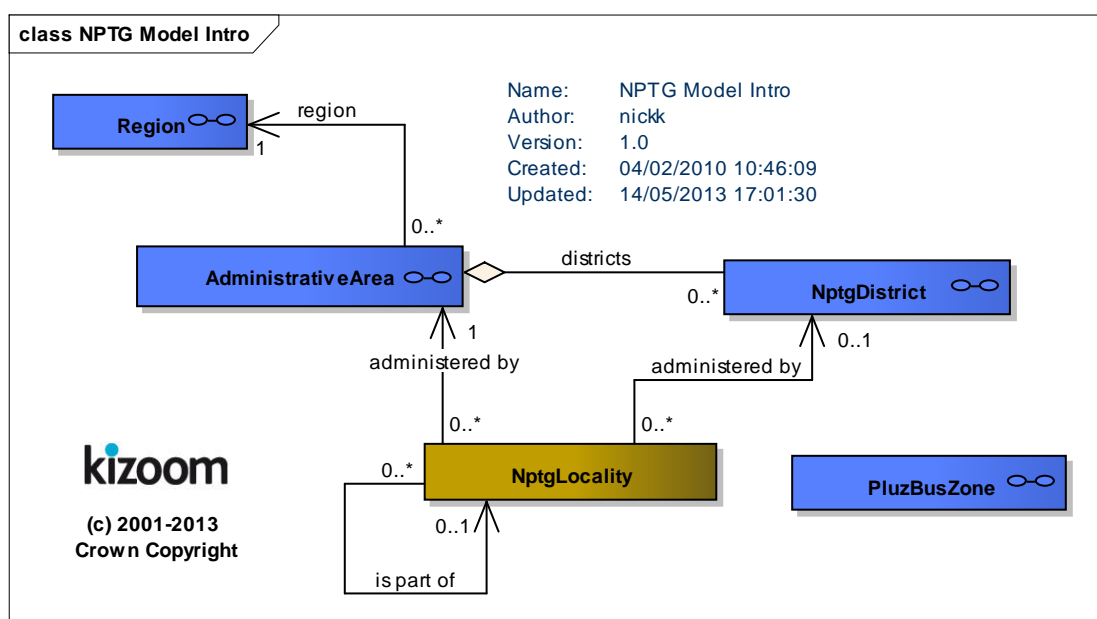

Figure 3-1 – UML Diagram of NPTG Model: Introduction

3.1.1 Topographical Elements

The fundamental entity of the *NPTG* is the *NptgLocality*, which represents a UK city, suburb, district, village, town or other settlement, for example, 'Holborn', 'Cardiff', 'North Wootton, Somerset' or 'Barnsbury, Islington'.

- Localities can be organised into hierarchies using an 'is part of' relationship.
 - The 'is part of' relationship implies that the contained element is inside its parent element.
 - An arbitrary number of levels may be used, though currently at most three levels are used in practice. Parent references should not be cyclic, that is a locality should not be part of itself, directly or indirectly. ,

- A parent element will not necessarily be uniformly divided into children: typically there may be additional children covering town centres and areas significant for travel. Other areas may be more sparsely covered.
- Localities may overlap. Localities may be used to describe geographically fuzzy areas like *'The West End'* or *'South Bank'*.
- Each **NptgLocality** has a **Location**, specifying the geospatial coordinates, ideally at 1m precision, of a central point for the locality.
- Each **NptgLocality** has a name and an optional short name which can be used to qualify other names. Each **NptgLocality** may have multiple **AlternativeDescriptor** instances, each specifying alternative names for the locality. For example, *Swansea* has an alternative common name of *'Abertawe'* where the alternative name is being used for a bilingual (Welsh) variant of its name.
- Each **NptgLocality** is associated with a single **AdministrativeArea**, representing a Metropolitan PTE, a Shire County or a Shire Unitary Authority (the authority with transport responsibilities).
- Each **NptgLocality** can also be associated with an **NptgDistrict**, a subdivision of **AdministrativeArea**.
 - The district specifies the Local Authority to which the **NptgLocality** belongs. A district will correspond to governmental district, thus be a Borough, District or Metropolitan Borough of the UK.
 - For each **AdministrativeArea** that is a Shire or Metropolitan County, there is an **NptgDistrict** for each subdivision of the administrative area.

Figure 3-2 elaborates, in UML class diagram notation, the elements of the *NPTG* Locality Model to show attributes and ancillary elements.

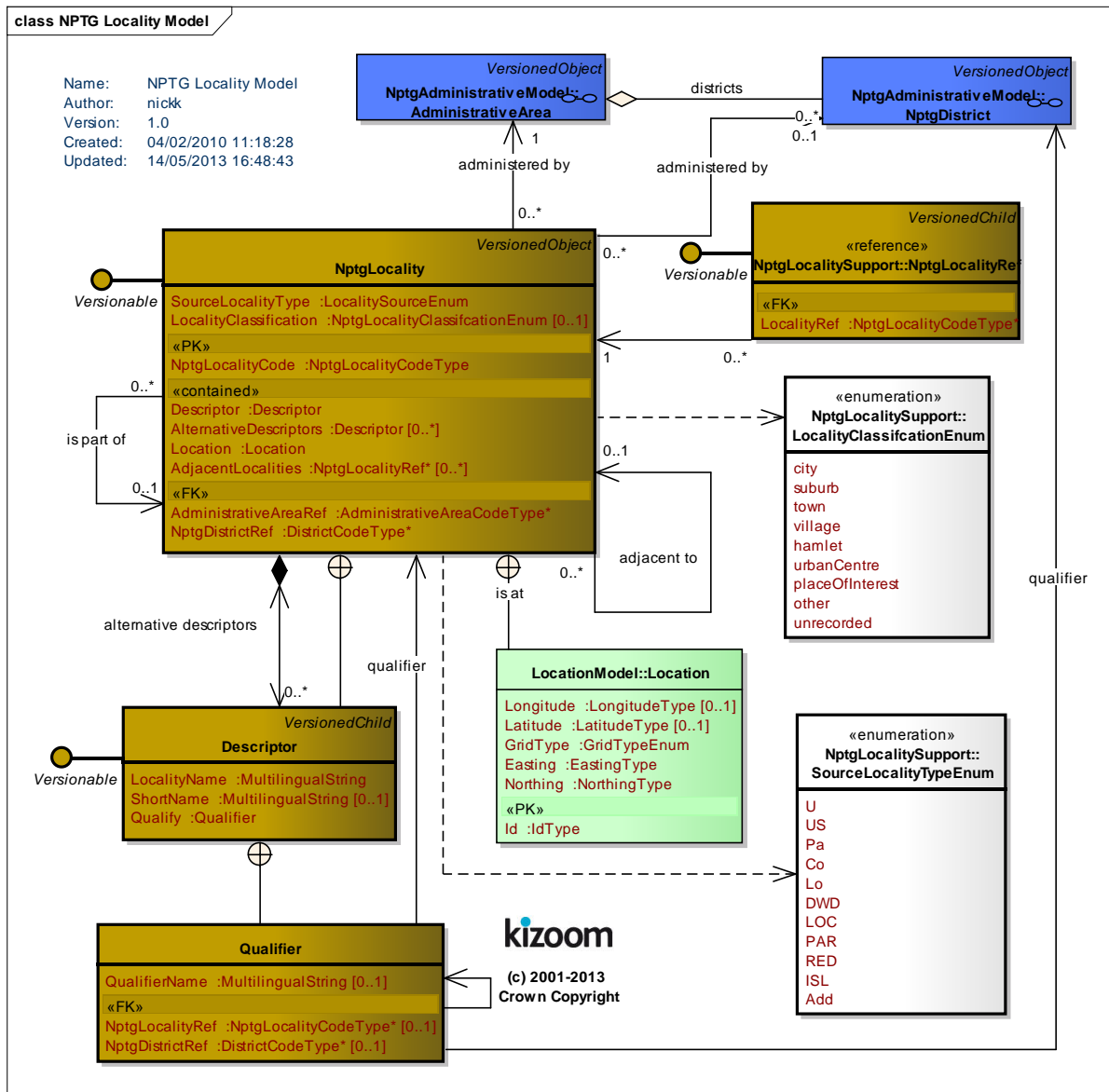

Figure 3-2 – UML Diagram of NPTG Locality Model

3.1.2 Administrative Elements

Figure 3-3 introduces, in UML class diagram notation, the elements of the *NPTG* Administrative Model, which assign responsibility for managing locality data:

- Great Britain is divided into Traveline **Region** instances.
- Every **Region** contains a number of **AdministrativeArea** instances.
- Each **NptgLocality** and **NptgDistrict** belongs to a specific **AdministrativeArea**.
- Great Britain also contains a number of **PlusbusZone** instances. These are Tariff zones for the Plusbus scheme.

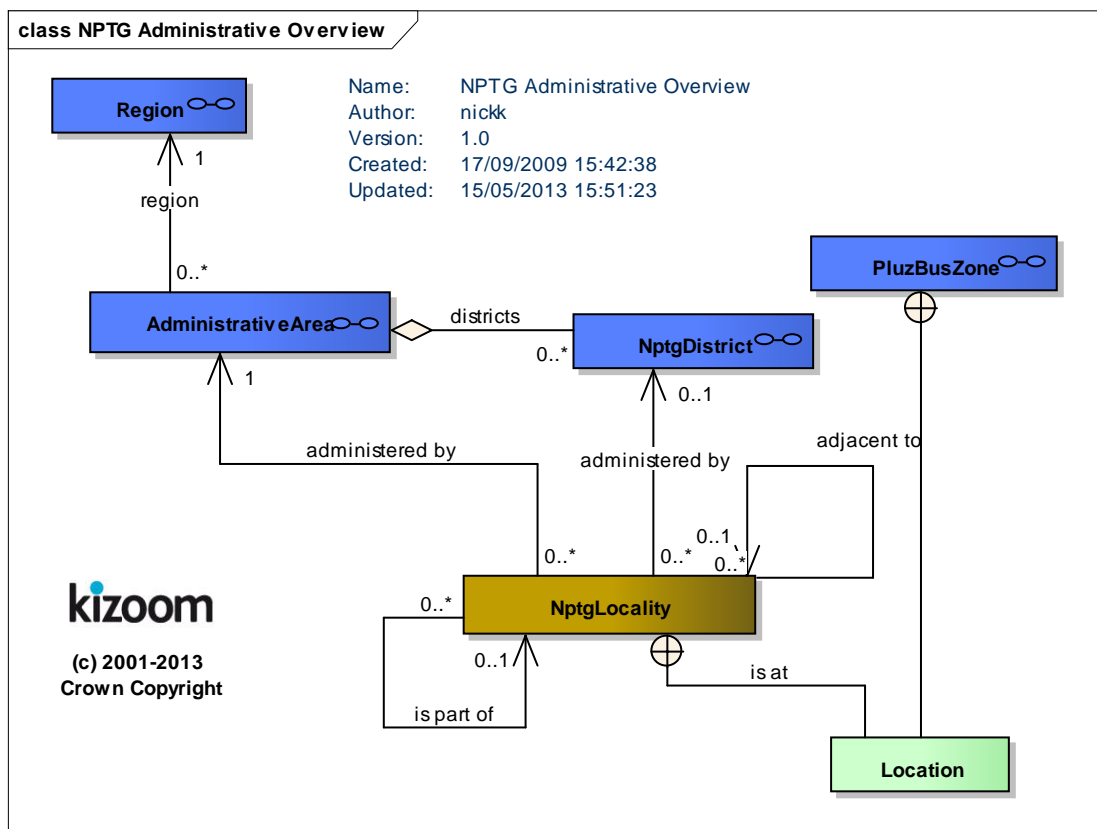

Figure 3-3 – UML Diagram of NPTG Administrative Model: Overview

Figure 3-4 elaborates the same elements as in Figure 3-3 with some further detail showing additional child elements of AdministrativeArea.

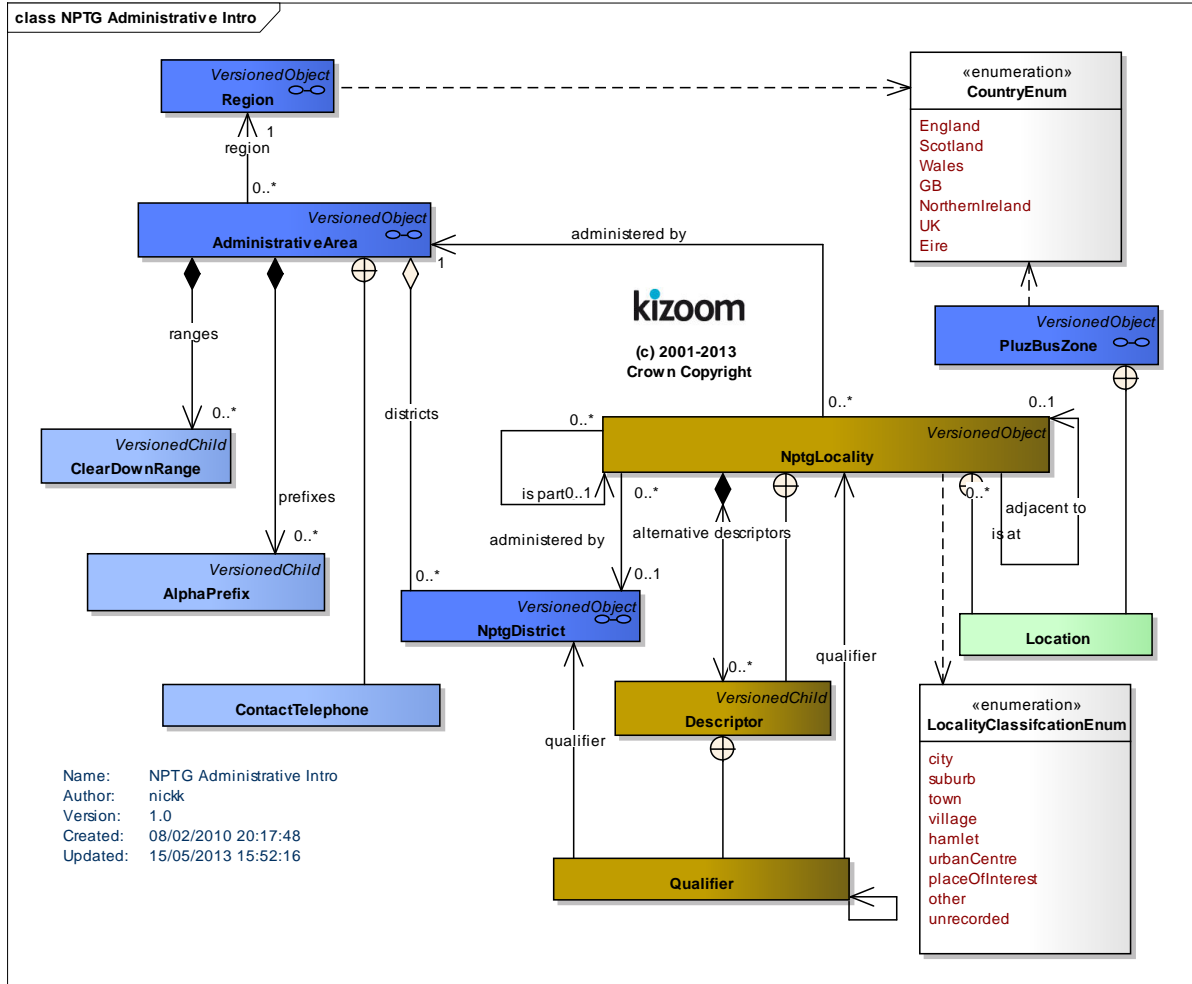

Figure 3-4 – UML Diagram of Main NPTG Model: Further elements

Figure 3-5 shows the same elements as in *Figure 3-4* with further detail as to the properties of individual entities.

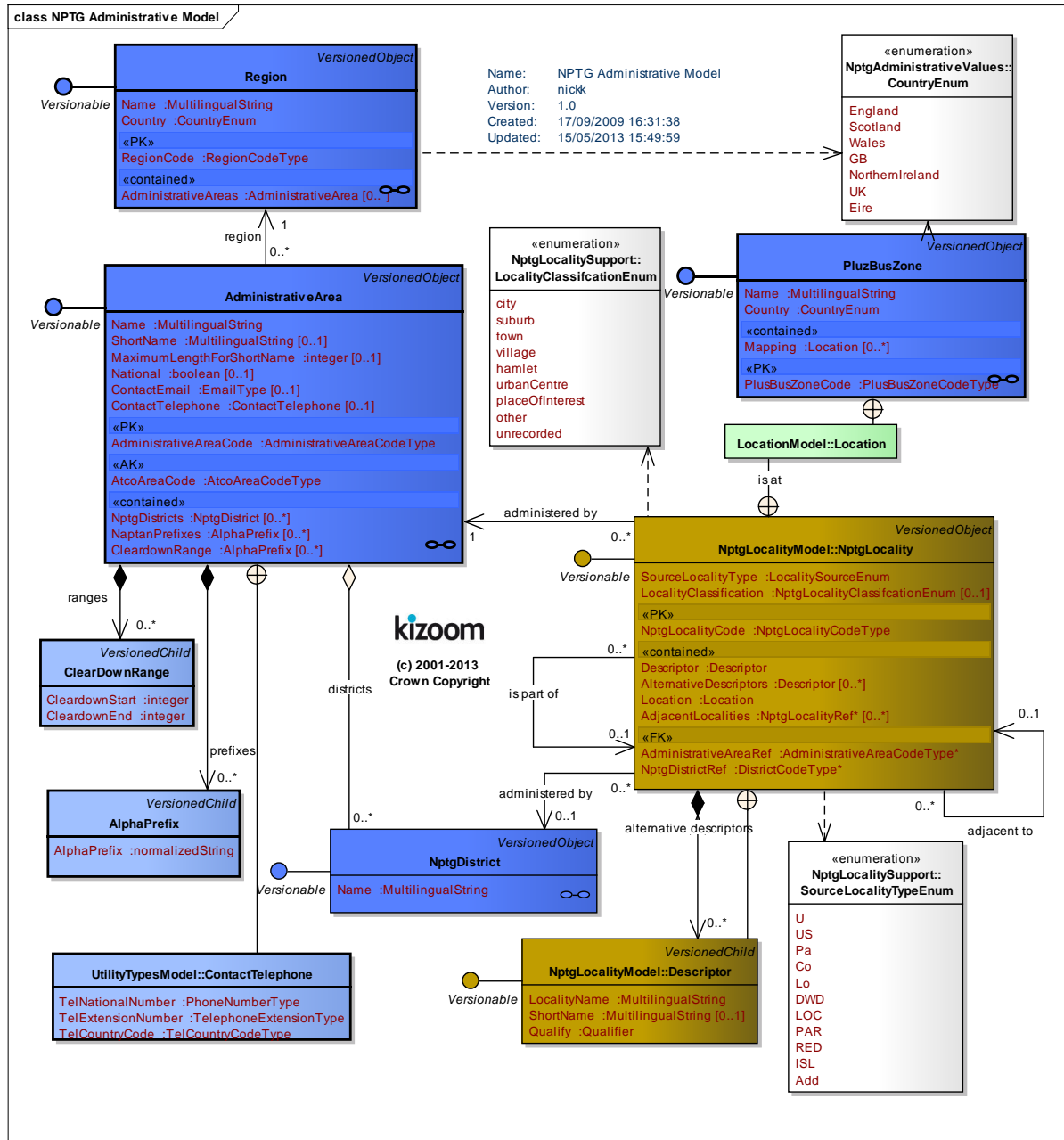

Figure 3-5 – UML Diagram of Main NPTG Model: Detail

3.1.3 NPTG Element Hierarchies

3.1.3.1 NPTG Locality Element Hierarchy

Figure 3-6 shows the Class Hierarchy for the NPTG Locality Elements. **NptgLocality** is a versioned element. **NptgLocalityRef** & **Descriptor** are child elements.

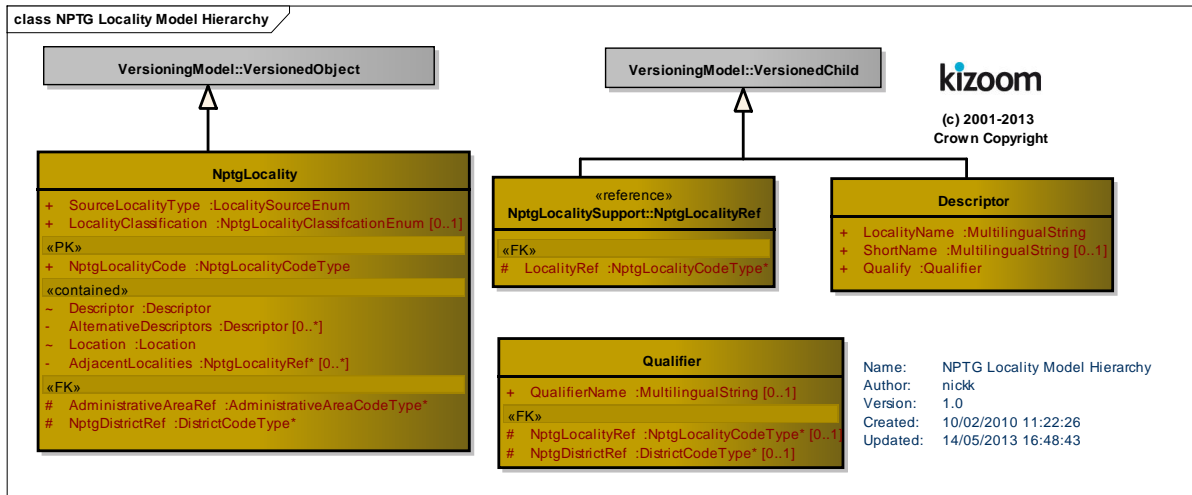

Figure 3-6 – UML Diagram of NPTG Locality Element Hierarchy

3.1.3.2 NPTG Administrative Element Hierarchy

Figure 3-7 shows the Class Hierarchy for the NPTG Administrative Elements. **Region**, **AdministrativeArea**, **NptgDistrict** and **PlusBusZone** are versioned elements. **CleardownRange** & **AlphaPrefix** are child elements.

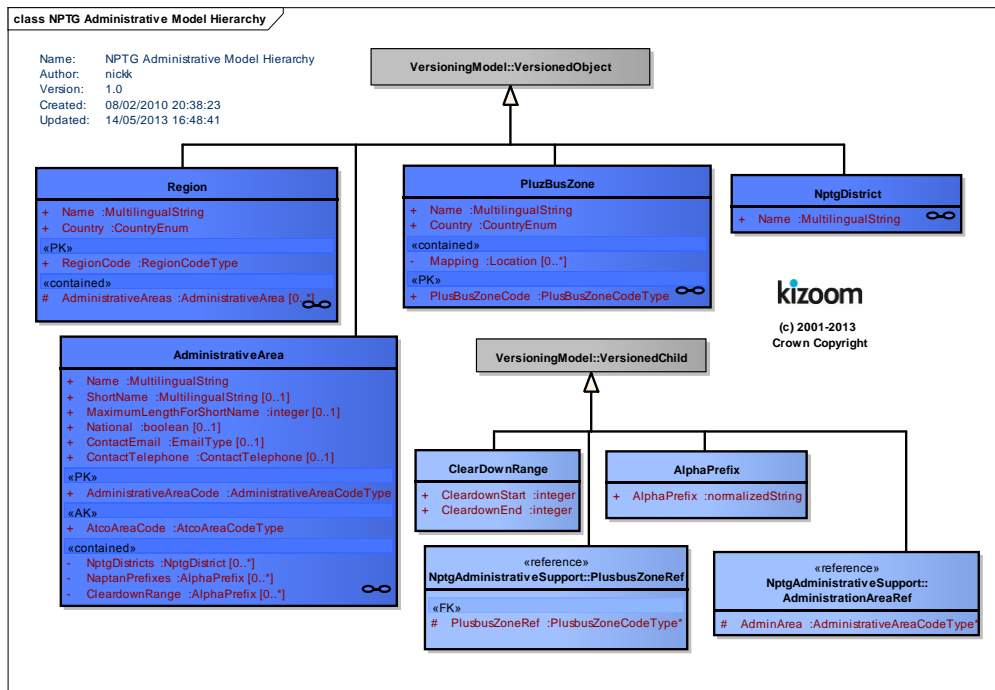

Figure 3-7 – UML Diagram of Administrative Element Hierarchy

3.1.3.3NPTG Locality Data Types

Figure 3-8 shows the data types used in the locality elements in Figure 3-2 and elsewhere.

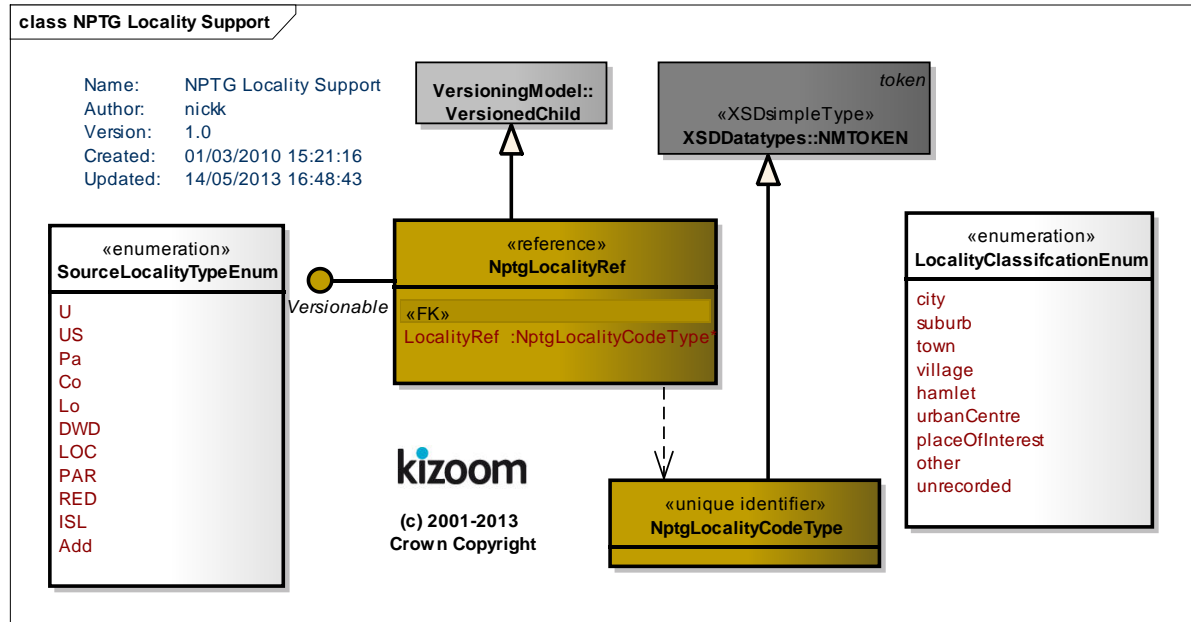

Figure 3-8 – UML Diagram of Locality Data types

3.1.3.4NPTG Administrative Data Types

Figure 3-9 shows the data types used in the administrative elements in Figure 3-5 and elsewhere.

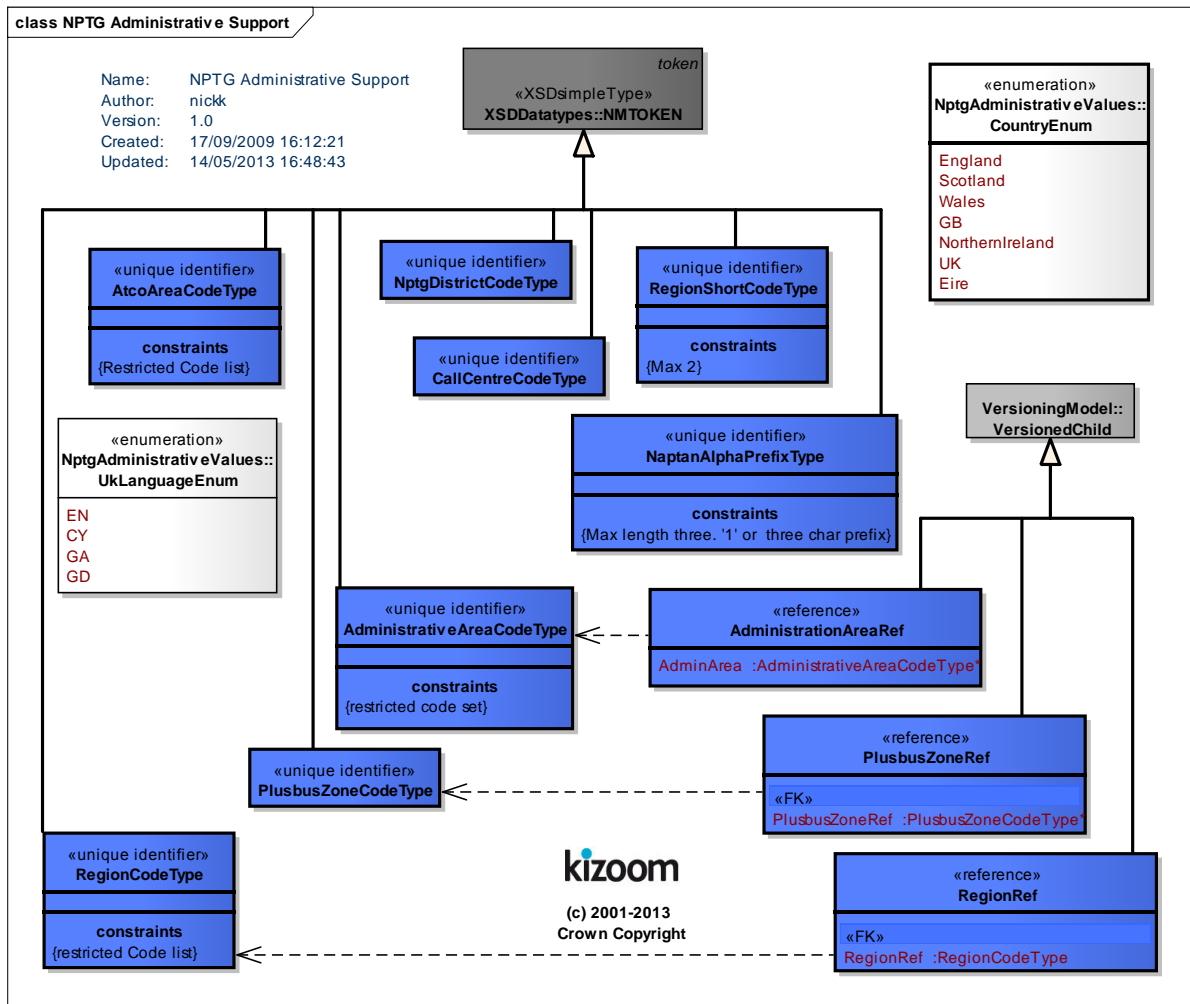

Figure 3-9 – UML Diagram of Administrative Data Types

3.1.3.5NaPT Location Data Types

Figure 3-10 shows the reusable **Location** data types used for a geospatial point in Figure 3-5 and elsewhere.

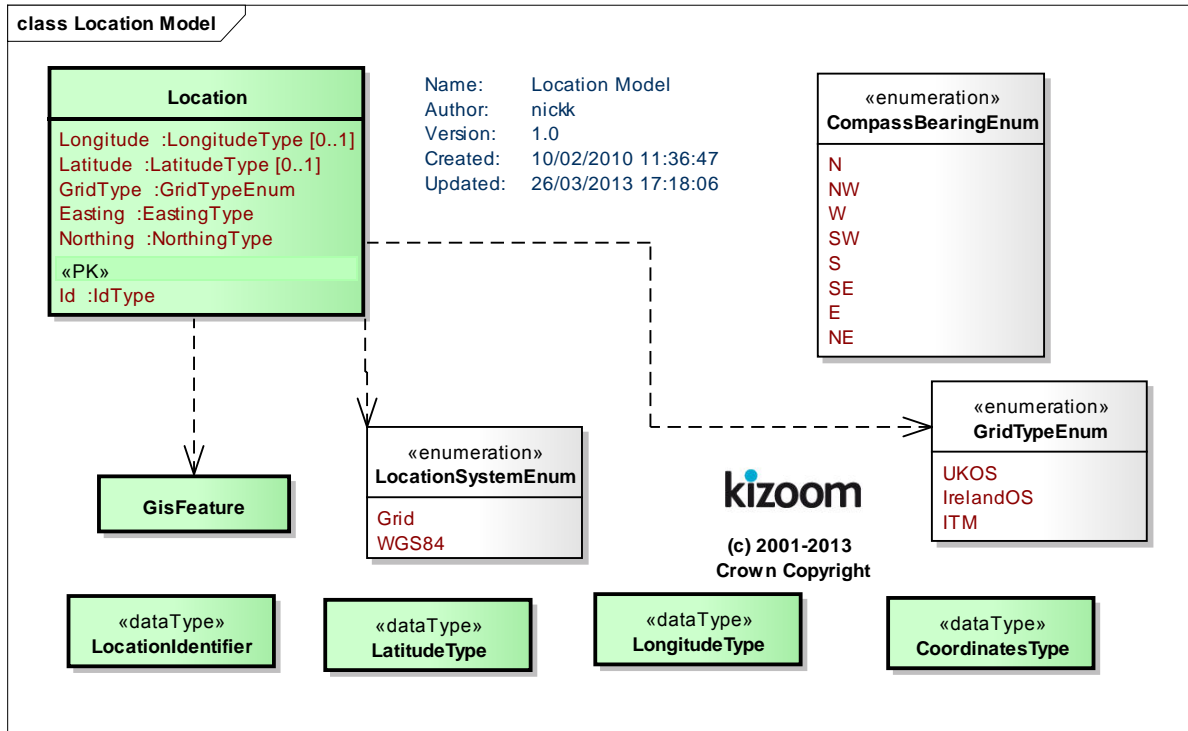

Figure 3-10 – UML Diagram of Location Data Types

3.1.3.6 Utility Data Types

Figure 3-12 shows the reusable Address data types used in Figure 3-5 and elsewhere.

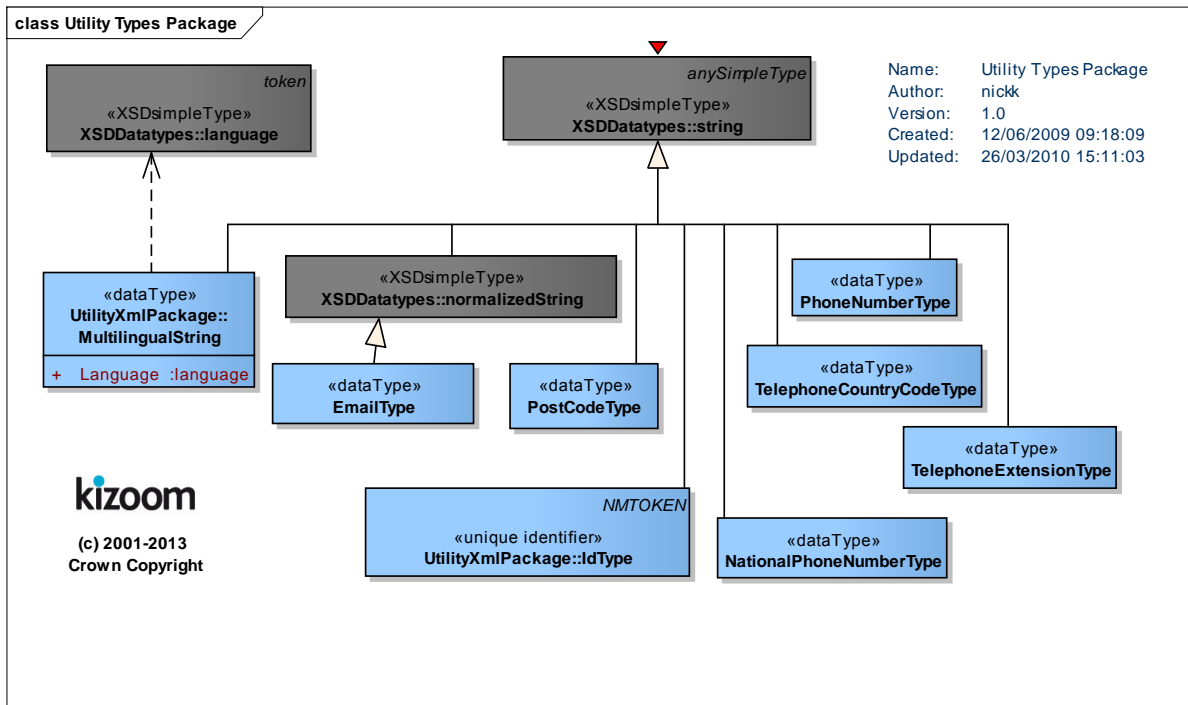

Figure 3-11 – UML Diagram of NaPT Utility Data Types

3.1.3.7 APD Data Types

3.1.3.8 Address Data Types

Figure 3-12 shows the reusable **Address** data types used in *Figure 3-5* and elsewhere.

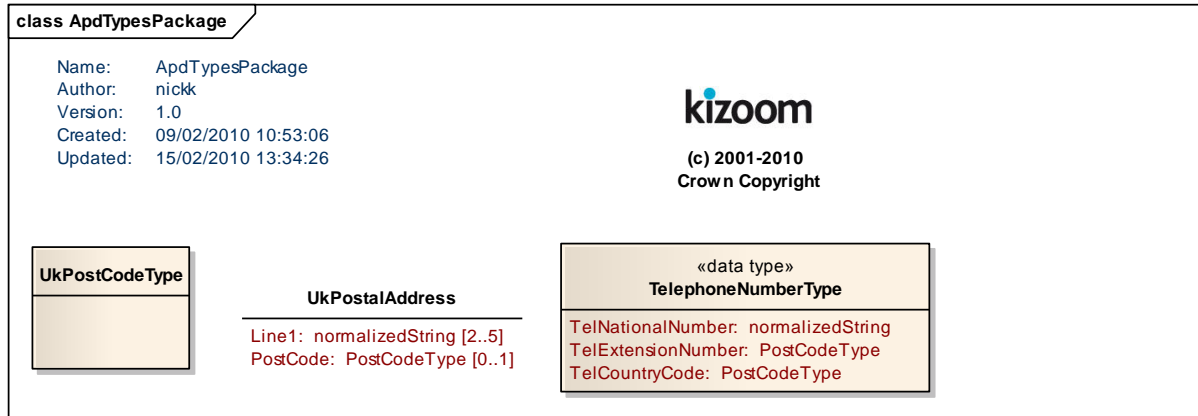

Figure 3-12 – UML Diagram of APD Address Data Types

3.2 Populating the National Gazetteer

The *NPTG* provides a structured model for describing the topography of the UK in a format that is useful for computer systems. When entering data into the *NPTG* model, care needs to be taken in choosing, naming and grouping localities so as to populate the model in a way that accurately reflects the way real-world places are named and perceived by humans, and also so that the relationships between them are useful for the intended computational purposes.

3.2.1 Choosing Administrative Areas

There should be an *NPTG* administrative area for every English, Scottish and Welsh County, including metropolitan counties such as Greater London and Greater Manchester, and every Shire Unitary authority. These are the country's local transport authorities.

- There are currently 146 administrative areas.
- There are also two special administrative areas for National Rail and National Coach Data.

Names of Administrative Areas should be unique within the *NPTG* database. A short name can be associated with each area, to use when distinguishing localities from different areas that have the same name.

An ampersand symbol ('&') should be used in the naming of administrative areas in preference to the word "and", so that the word "and" can be used in downstream systems to logically connect two or more such administrative areas without ambiguity (for example. '*Bath & North East Somerset*' and '*North Somerset*').

3.2.2 Choosing NPTG Districts

There should be an *NPTG* District for the following:

- Every Metropolitan District Council.
- Every Shire District Council.

The name should be the same as the local authority name, without the descriptive suffix (i.e. 'Council', 'District Council', 'Borough Council', 'City Council', 'London Borough of' etc). For example, '*Eden*' for '*Eden District Council*', '*Haringey*' for '*London Borough of Haringey*', '*Manchester*' for '*Manchester City Council*'.

Those Administrative Areas which are shire unitary authorities do not have a district. There are currently 274 *NPTG* Districts. Names of Districts should be unique within the UK.

3.2.3 Choosing & Grouping NPTG Localities

3.2.3.1 Localities

A locality represents a topographic area, that is, a named settlement. There should be a locality for:

- Every City.
- Every Town.
- Every Suburb or District.
- Every Village.
- Every Hamlet.

3.2.3.2 Town and City Centre Localities

You may choose also to add localities to represent specifically the centre or other important area of a town or city: in this case the city name should be the qualifier. For example, '*Southampton City Centre*' and '*Shirley Town Centre*' in the example in *Figure 3-13*. '*Town Centre*' or '*City Centre*' is preferred as a naming phrase rather than simply '*Centre*' so as to distinguish the locality from those Sports and Leisure Centres and other Points of Interest that have Centre in their name (e.g. '*The Sobell Centre*'). Creation of a settlement centre area is recommended for settlements that themselves have child localities within them.

3.2.3.3 Places of Interest versus Localities

Localities should not normally be created for places that are simply points of interest, for example 'Wembley Stadium'; data for such places will be covered by a Point of Interest from a point of interest database such as *PointX*. However, it may occasionally be appropriate to add a locality for a point of interest that is also in effect a destination locality (i.e. with potentially many otherwise unrelated access points), not covered by other locality definitions, in particular if no part of the name overlaps with the locality. Thus, for example, one might include 'Blenheim Palace' which is in *Woodstock*, but exclude 'Harlech Castle', because 'Harlech' will already exist as a locality, and will appear in search results.

3.2.3.4 Locality Hierarchies

Lower level localities should have their parent locality specified. Typically three levels of hierarchy should suffice for most localities. For example, *Figure 3-13* shows a hierarchy for part of the *Southampton* area.

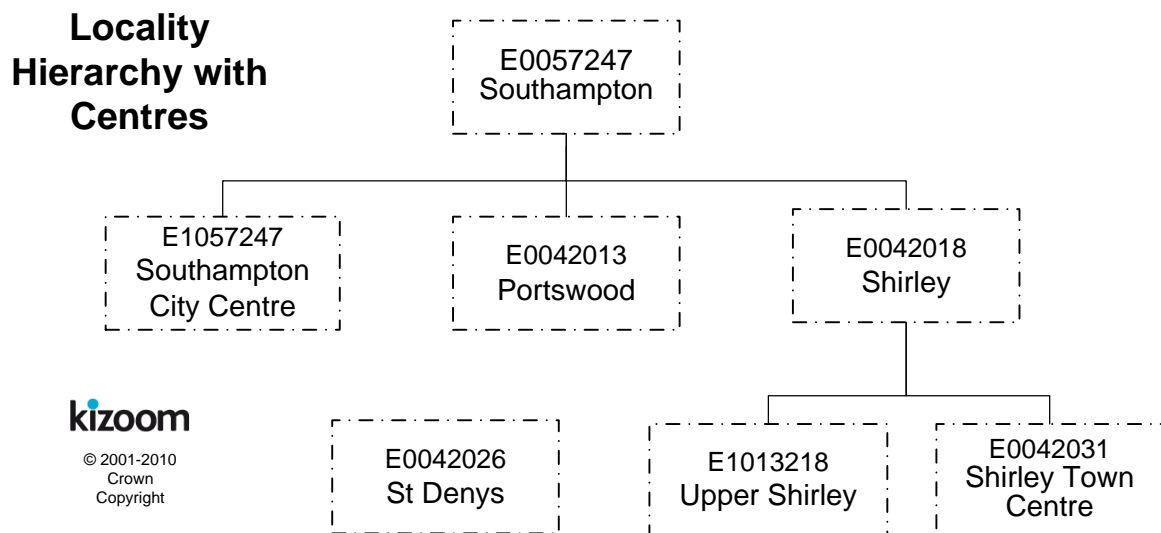

Figure 3-13 – Example: Locality Hierarchy

3.2.4 Naming NPTG Localities

Where there are two places with the same name within the UK, you should set the '**Qualifier**' property of the *NPTG* locality, so that the fully qualified name of each locality is unique within the UK. For example, 'Gillingham (Kent)' and 'Gillingham (Dorset)' are both named 'Gillingham', but have different qualifiers – 'Kent' and 'Dorset' respectively. When appropriate, journey planners and other applications will append the qualifier to the locality name so as to distinguish the two instances.

For example *Table 3-1* shows how names might be derived for two different 'Gillingham' instances.

Locality Name	Qualifier	Qualified Name - Derived
Gillingham	Kent	Gillingham (Kent).
Gillingham	Dorset	Gillingham (Dorset).

Table 3-1 – Example of Qualified Locality Names

3.2.4.1 General Rules for the Names of NPTG Localities

The following general rules should be applied to naming *NPTG* localities:

- **Capitalization:** The preferred style of locality names, in *NPTG* is 'title case', that is, lower case with the first letter of each significant word in upper case, for example, '*Milton Keynes*', '*Up-Mudford*'. Prepositions and articles within a name should be in lower case; '*Cley-next-the-Sea*', **not** '*Cley Next The Sea*'. Similarly; '*Isle of Man*', '*Slyne-with-Hest*', '*Kirkby-in-Furness*'. Prepositions and articles derived from Latin or other languages should not be capitalised either; '*St George's-super-Ely*', '*Poultton-le-Fylde*'. Additional considerations apply to the capitalisation of Welsh names to follow preferred Welsh usage.
- **Character Set:** Only uppercase and lower case letters should be used in locality names. Accented characters are permitted. Hyphens may be used within names, for example '*Hutton-le-Hole*', as may apostrophes, for example '*St Margarets*' and ampersands, for example '*Bat & Ball*'.

- Specifically the use of digits, non-alphabetic characters, and any punctuation characters other than apostrophes and hyphens should be avoided in common names and locality names. Numbers should be spelt out e.g. '*Seven Sisters*', **not** '*7 Sisters*'. Certain characters are forbidden in names by the *NaPTAN* schema; in particular commas and the other characters in *Table 3-2* should **not** be used as their use in a *NaPTAN* document will render it invalid.

Character	Name	Why character is reserved.
,	Comma	Used as separator for qualifier
{	Left Square Bracket	Used to format output
}	Right Square Bracket	Used to format output
{	Left Brace	Used to format output
}	Right Brace	Used to format output
^	Caret	Inappropriate
=	Equals	Inappropriate
@	at	Inappropriate
:	colon	May be used to format output
;	semicolon	May be used to format output
#	hash	Input expression
\$	Dollar	Input expression
£	Pound	Inappropriate
?	Question mark	Inappropriate mood
%	Percent	Input expression

Table 3-2 – Characters that are invalid in NPTG & NaPTAN Place and Common Names

- The use of certain other non-alphabetic characters is also strongly discouraged. . Further automatic validation to prevent the use of other inappropriate characters (see *Table 3-3*) may be added to the schema in future.

Character	Name	Why character is discouraged.
+	plus	Input expression
<	Left than	Used to format output
>	Greater than	Used to format output
«	Left guillemot	Used to format output
»	Right guillemot	Used to format output
\	Back slash	Better to use alternative name
/	Forward slash	Better to use alternative name
	at	Better to use alternative name
~	tilde	Inappropriate
_	underscore	Inappropriate
¬	hash	Input expression

Table 3-3 – Characters Not To Be Used in NPTG & NaPTAN Place and Common Names

- **Use of Brackets:** In *NaPTAN* 1.x round brackets were used to wrap a qualifier within a name, for example '*The Knap (Vale of Glamorgan)*'; in *NPTG* 2.x the qualifier should **not** be included in the locality name as it should be held separately in the **Qualifier** element. If it is needed in the presentation of a name it can be appended automatically and the brackets supplied by the formatter.
- **Use of Numbers:** Numbers should be written out as words, for example '*Seven Oaks*', not '*7 Oaks*'.

- **Hyphenation:** Names should be hyphenated according to the preferred form of native usage. In British place names, hyphenation occurs in two circumstances:
 - Proper nouns, for example, *'Duddington-Fineshade'*, *'Lawton-Gate'*. Hyphenation of two proper nouns is common in Welsh names, but rare in English place names – for a full list of the latter see *Table 3-4*.

Lawton-Gate	Pen-Alt	Duddington-Fineshade	Clachan-Seil
Up-Mudford	Pentre-Jack	Stowey-Sutton	Lower Maes-Coed
Knight-Ley	Thing-Hill	Norton-Radstock	Windy-Yett
Edge-End	Stone-Edge Batch	Banchory-Devenick	
Lane-End	Touchen-End	Buchanhaven-Catto	
Over-ross	Lockington-Hemington	Leochel-Cushnie	

Table 3-4 – English Locality Names without any Preposition that are Hyphenated

- Some British place names contain hyphenated prepositions and/or articles, for example *'Lilford-cum-Wigestead'*, *'Hinton-in-the-Hedges'*, *'Laughton-en-le-Morthen'*, *'Rhyd-y-Pandy'*, *'Ty'n-twr'*, *'Praze-an-Beeble'*. Where there is a choice of usage, the hyphenated form is preferred, according to the style of the Times Gazetteer. See *Table 3-5*.

lang	Preposition	Example	Hyphenate	FIX
	a	<i>Hook-a-Gate</i>	always	ok
	at	<i>Cross-at-Hand, Stratford atte Bowe</i>	always	ok
	by	<i>Middleton-by-Youlgreave</i>	always	fix
	cum	<i>Shingay-cum-Wendy, Haversham-cum-Little Linford</i>	always	fix
	de la	<i>Ashby-de-la-Zouch</i>	always	fix
	le, la, en le	<i>Poulton-le-Fylde, Laughton-en-le-Morthen, Sturton-le-Steeple</i>	always	fix
	In / In the	<i>Hinton-in-the-Hedges; Sandside (Kirby-in-Furness) St Just-in-Roseland</i>	always	
	next	<i>Wells-next-the-Sea</i>	always	
	of	<i>Isle of Dogs</i>	never	ok
	on / on the	<i>Frisby-on-the-Wreak, Northwood (Stoke-on--Trent), Lydford-on-Fosse</i>	by usage	
	sub	<i>Westbury-sub-Mendip</i>	always	fix
	super	<i>Weston-super-Mare</i>	always	fix
	the	<i>East-the-Water</i>	by usage	
	to	<i>Come-to-Good</i>	always	ok
	upon	<i>Oldbury-upon-Severn</i>	always	
	under	<i>Weston-under-Lizard</i>	always	
	up	<i>Up-Mudford</i>	always	ok
	with	<i>Slyne-with-Hest, Little Eccleston-with-Larbreck</i>	always	fix
cy	ar	<i>Llanfihangel-ar-Arth</i>	by usage	
cy	y	<i>Pant-y-Gog, Pen-bont-rhyd-y-beddau</i>	by usage	
cy	yr	<i>Ty'n-yr-eithin</i>	by usage	

Table 3-5 – Hyphenation of Prepositions & Articles in NPTG Locality Names

- **Use of Periods:** Full stops must not be used within names, for example use just *'St'* rather than *'St.'*; do not put a final period on names.
- **Use of Commas:** Commas must not be used within names, as commas are conventionally used by presentation programs to indicate the concatenation of discrete elements when formatting names.
- **Use of Hyphens:** Hyphens should be used around prepositions for example *'Kirkby-in-Furness'*, **not** *'Kirkby in Furness'*. See section 3.5.11.1 below.
- **Use of Apostrophes:** Apostrophes should be used in line with the preferred local practice. For example, *"Robinson's End"*, *"Cross o' th' Hands"*, *"Tolleshunt D'Arcy"*, *"Blo'norton"*, *"Ty'n-y-groes"*.
- **Use of Articles:** For those English place names that include the English definite article (*'The'*) *before the name*, the article should be included in the locality name, before the proper noun, for example *'The Maltings'*, **not** *'Maltings, The'*. An alternative name without the article may also be included; for example *'The Chuckery'*, + *'Chuckery'*; *'The Dunks'*, + *'Dunks'*, however most search engines will allow for the article.
- **Use of Ampersand:** *'&'* is preferred to *'and'* for a conjunction, for example, *'Bat & Ball'* rather than *'Bat and Ball'*. However use of a conjunction in a locality name is usually an indication of a missing locality. A locality is a singular concept and any locality name that joins two or more separate designations should be broken down into the two or more component

localities which contain an Ampersand ('&') or the word "and" should be reviewed and revised to remove the use of the conjunction.

- **Use of Abbreviations:** Abbreviations should be avoided in locality names, for example 'Great Missenden' and **not** 'Gt Missenden' unless length limitations require their use (Location names in the NPTG database can be up to 48 characters long. Standard abbreviations are given in 15.4. Two exceptions to this are (i) the abbreviation for 'Saint', where 'St' should always be used, for example 'St Quivox', or 'Ilketshall St John'. (ii) the abbreviation 'nr' should be used rather than 'near', for instance 'Frogmore (near King's Walden)'.
- **Use of Acronyms:** Acronyms should not be separated by a period, for example. 'RAF', 'HQ', **not** 'R.A.F.', 'H.Q.'
- **Spacing:** Words should be single spaced, without leading or trailing blanks.
- **Use of Forward Slash** The uses of slash in locality names to denote alternatives is not acceptable – if there is an alternative then a separate record should be created to specify the alternative descriptor.

3.2.5 Geocoding NPTG Localities - Locations

Every NPTG locality has a set of spatial coordinates at 1m precision, specified by a **Location** element. The point should be in a public area at the 'business' centre of the locality on a road open to all traffic, and might correspond to the position of a particular centrally located PTAN.

NPTG supports the use of either or both Ordnance Survey grid location coordinates and WGS location coordinates. When submitting NPTG Localities, only OS grid coordinates need be given. The distributed NPTG localities will include both Grid (OS or ITM) and WGS 84 Coordinates.

3.3 The NaPTAN Model

3.3.1 Overview of NaPTAN Model

The *NaPTAN* schema builds on the *NPTG* schema, to define Public Transport Access nodes (i.e. stops) for all modes of transport.

Figure 3-14 shows, in UML class diagram notation, the main elements of the *NaPTAN* schema. The two fundamental entities of the *NaPTAN* schema are **StopPoint** and **StopArea**. These can both be associated with an AdministrativeArea. A **StopPoint** is associated with an **NptgLocality** which indicates the topographic place (village, town n city etc) where it is located.

A **StopPoint** may also be assigned to a **TariffZone** to indicate the fare zones to which it belongs. A set of **TariffZones** is grouped as a **Network, i.e. "fare scheme"**. For example, Zones 1 -9 in the TfL London metro system. NaPTAN can also be used to identify significant points of interest as a **PointOfInterest**. Both **StopPoint** and **PointOfInterest** are types of **Site**.

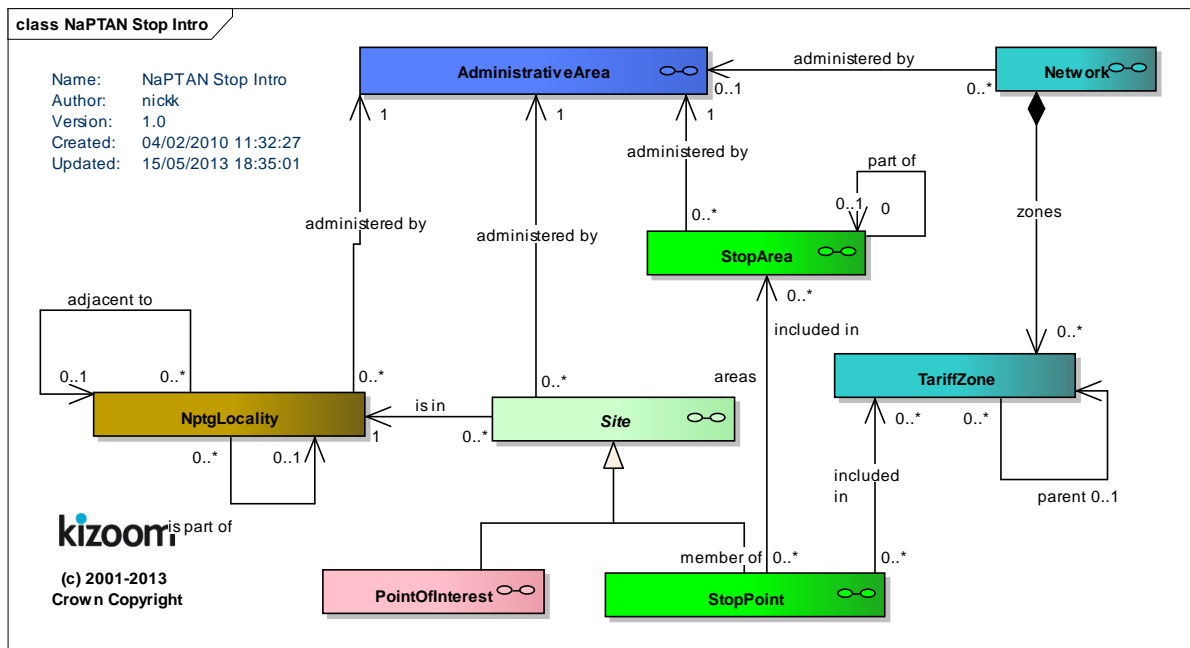

Figure 3-14 – UML Diagram of primary NaPTAN elements

Figure 3-15 elaborates, in UML class diagram notation, the main elements of the *NaPTAN* schema. A **StopPoint** represents a point of access to public transport, for any mode of travel – bus, rail, air, taxi, etc – including bus stops, stations, and ferry ports.

- The type of PTAN is described by a **StopClassification** – this is described further in the next section.
- The **StopPoint** is a specialisation of a **Site**.
- A **Site** is a general purpose description of a named location that has certain specific properties including a **Descriptor** element, which groups the textual elements used to describe and name the **Site** systematically. A **Site** may also have multiple **AlternativeDescriptor** instances by which it is known; alternate descriptors may also be used to provide bilingual names.
- Every **Site** has a **Place** element, which describes its **Location** (geocode) and other information about the locality in which it is situated.
 - Every **Site** is assigned to a primary **NptgLocality** element, which describes the settlement within which it is sited. The primary locality should always be the most specific available: for example in the hierarchy in Figure 3-13, a stop in 'Upper

- *Shirley* should use the more specific *Upper Shirley* rather than its parent *Shirley*, or grandparent; *Southampton*.
- A **Site** may optionally also be assigned to additional adjacent **NptgLocality** instances which are nearby. For flexible zones and for hail-and-ride sections which have an extended footprint (i.e. are not just single points), the stop should be assigned to a primary locality, but may also be associated with additional localities in which it lies, or which it serves by proximity.
- Those few **StopPoint** which represent the main points of access to public transport for a locality (a bus station, railway station, or port) may be assigned as a *Main Access point* for a locality in a separate association with the **NptgLocality** element to that of the primary locality. See separate concept of a **TrunkLocality** in Section 7.6.
- The accessibility of a stop may be described using a **StopAccessibility** element.
 - The accessibility may be conditioned on a **DayType**, for example *Mondays to Friday 08am to 6pm*.
 - The accessibility may involve designated **AccessVehicleEquipment**. See below.

A **PointOfInterest** is another specialisation of **Site** and represents a place of interest that people might want to travel to other than a stop point, for example a museum, park, or sports stadium.

- The type of POI is described by a **VenueClassification** – this is described further in the next section.

A **StopArea** represents a grouping of related stop points. Stop areas may themselves be grouped hierarchically into larger stop areas using an 'is part of' relationship.

- A **StopArea** has a **Location** (geocode) and other descriptive elements.
- Every **StopPoint** and **StopArea** must belong to an NPTG **AdministrativeArea**, which is responsible for managing it and its data. A **StopArea** may belong to a different **AdministrativeArea** from that of some of the stop points it contains.
- The **StopArea** is considered to be associated with all the NPTG localities (and alternative localities) of its member stops. Different stops in a given stop area may belong to different **NptgLocality** instances. Normally the stops of a stop area will belong to the same **NptgLocality**, but it is possible that the stops may be in different NPTG localities that are either adjacent to each other, or contained within one or the other (that is, hierarchically, related through an 'is part of' association, either directly or indirectly).

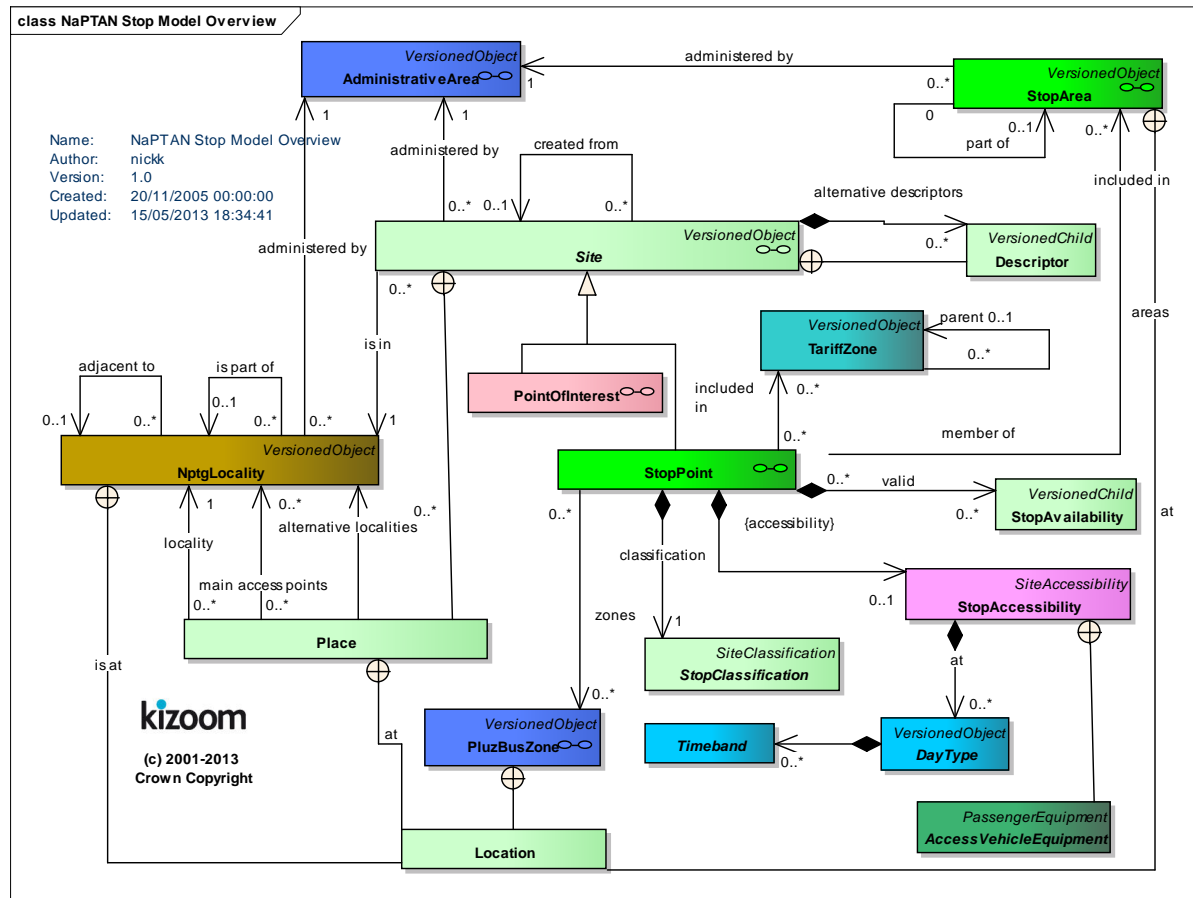

Figure 3-15 – UML Diagram of NaPTAN Model: Overview

Figure 3-16 shows the same elements as in Figure 3-15, with further detail as to the organisational elements of the schema, and the properties of individual entities. .

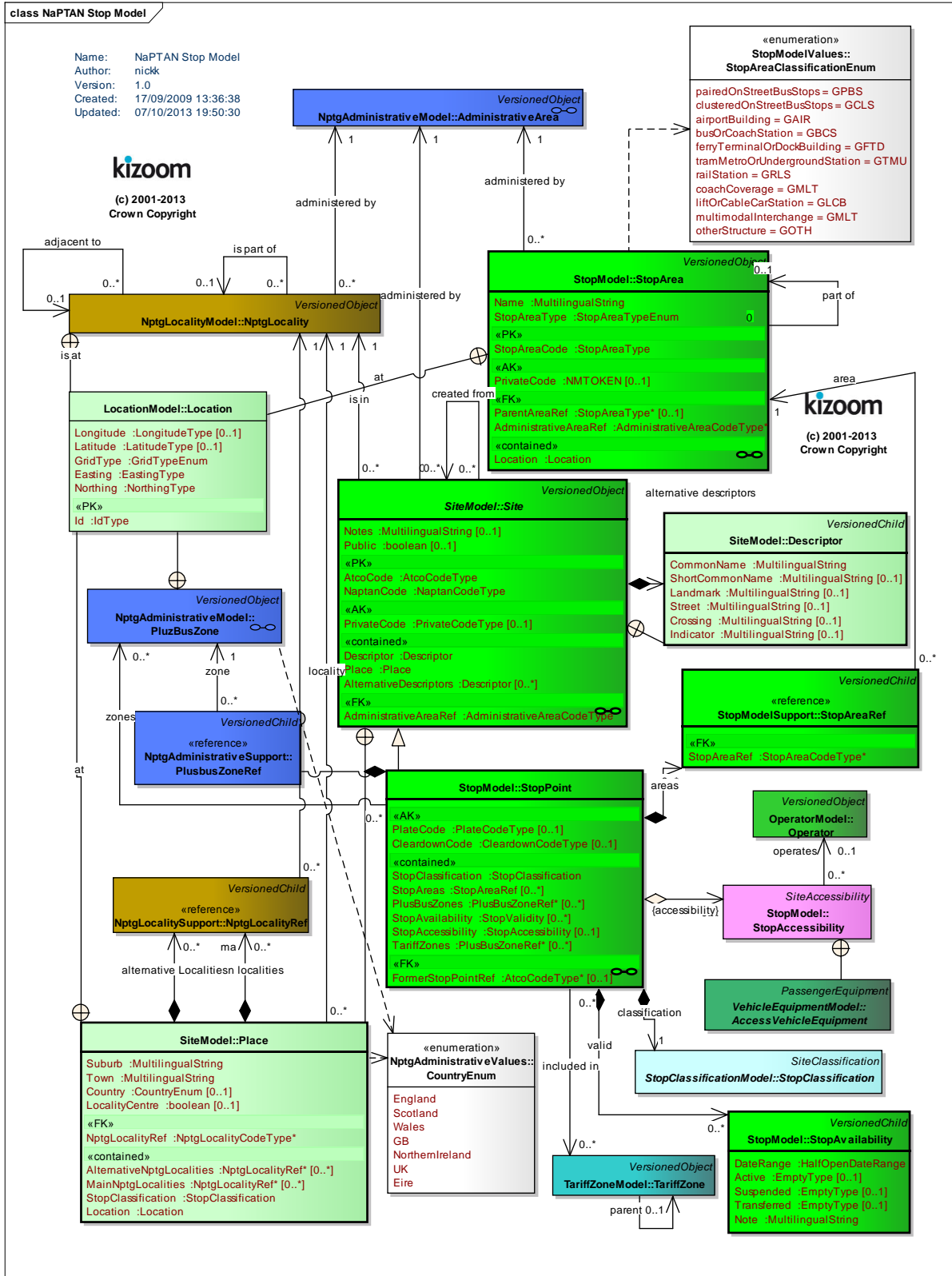

Figure 3-16 – UML Diagram of NaPTAN Model: Detail

3.3.2 NaPTAN Stop Point & Stop Area Types

3.3.2.1 Stop Point Types

There are a number of different types of **StopPoint** in the *NaPTAN* schema, some of which, for example bus stops, require additional details to be specified. *Figure 3-18* and *Figure 3-19* show, in UML class diagram notation, the *NaPTAN* stop type hierarchy, organised under the **StopClassification** element. Stops are organised into **OnStreet** and **OffStreet** types:

- **OffStreet** types represent stations and airports and other interchange facilities. For each mode of transport (**Air**, **Bus**, **Ferry**, **Metro and Rail**), an off-street stop point type may be either: Tram stops are also treated as stations.
 - An **Entrance** representing a physical point of access to the facility (the nature of this will depend on mode).
 - An **AccessArea**, that is the general air-side, dockside or platform interchange area. Note that a more detailed model of interchange structure is planned for the future that will refine this area.
 - A **Bay**, Gate or **Platform** element, used to represent the physical access point within the Interchange Building.
 - For bus and coach stations, a **VariableBay** can be used to indicate a stop point that is allocated to different bays at different times.

Additionally, optional **AnnotatedAirRef**, **AnnotatedCoachRef**, **AnnotatedRailRef**, **AnnotatedFerryRef** and **AnnotatedMetroRef** elements can be used to hold mode-specific codes to associate *NaPTAN* data with other reference systems.

- **OnStreet** types represent points on streets, grouped by transport mode (**Bus** and **Taxi**).
 - For **OnStreet / Bus** stop points (also covering coach), additional subelements may be required depending on type, for example **FlexibleZone** and **HailAndRideSection** instances describe details about flexible zone and hail and ride stops respectively.

StopPoint also has a single valued element, the **StopType**, which contains a three character code classifying the stop.

Figure 3-17 shows a summary of NaPTAN stop types.

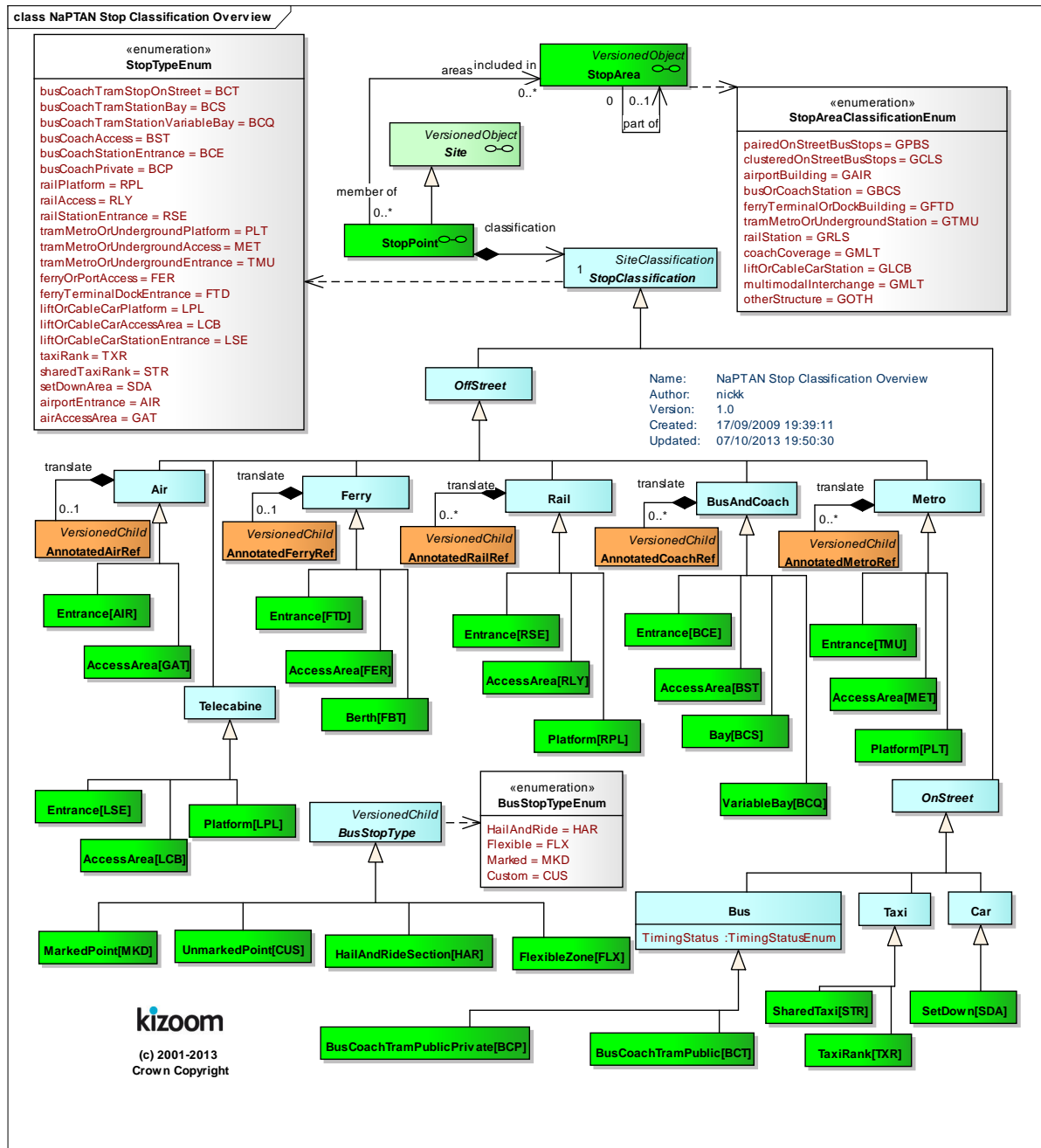

Figure 3-17 – UML Diagram of NaPTAN Stop Types

3.3.2.2 Stop Area Types

StopArea instances are also classified by transport mode – including some multimodal stop area types to combine stops of different modes.

- Each **StopArea** has a four character **StopAreaType** code, classifying the area type; stop points of a particular type may be associated with stop areas of particular types. *Table 3-6* shows the relationship between **StopPoint** classification elements (and **StopType** codes) and stop area classifications.

Group	Mode	Description	Stop Point Type				Stop Area
			Entrance	Access Area	Bay / Pole	Sub Type	Primary Area
Off Street	Air	Airport	AIR	GAT		--	GAIR
	Ferry	Ferry / Port	FTD	FER	FBT	--	GFTD
	Rail	Rail Station	RSE	RLY	RPL	--	GRLS
	Metro & Tram	Metro Station	TMU	MET	PLT	--	GTMU
	Bus & Coach	Bus or Coach Station	BCE	BST	BCQ	MKD	GBCS
			-	-	BCS	MKD	
Tele-cabine	Lift or Cable Car station (+NaPT v2.4)	LSE	LCB	LPL		GLCB	
On Street	Bus	Bus Coach on Street	-	--	BCT	MKD	GBPS, GCLS, GCCH
					BCT	CUS	
					BCT	HAR	
					BCT	FLX	
	Taxi	Taxi Rank	TXR	--		--	--
Car	Pick up and set down area	SDA	--		--	--	

Table 3-6 – Combining Stop Point & Stop Area Classifications

Figure 3-18 shows further details for NaPTAN off-street stop types.

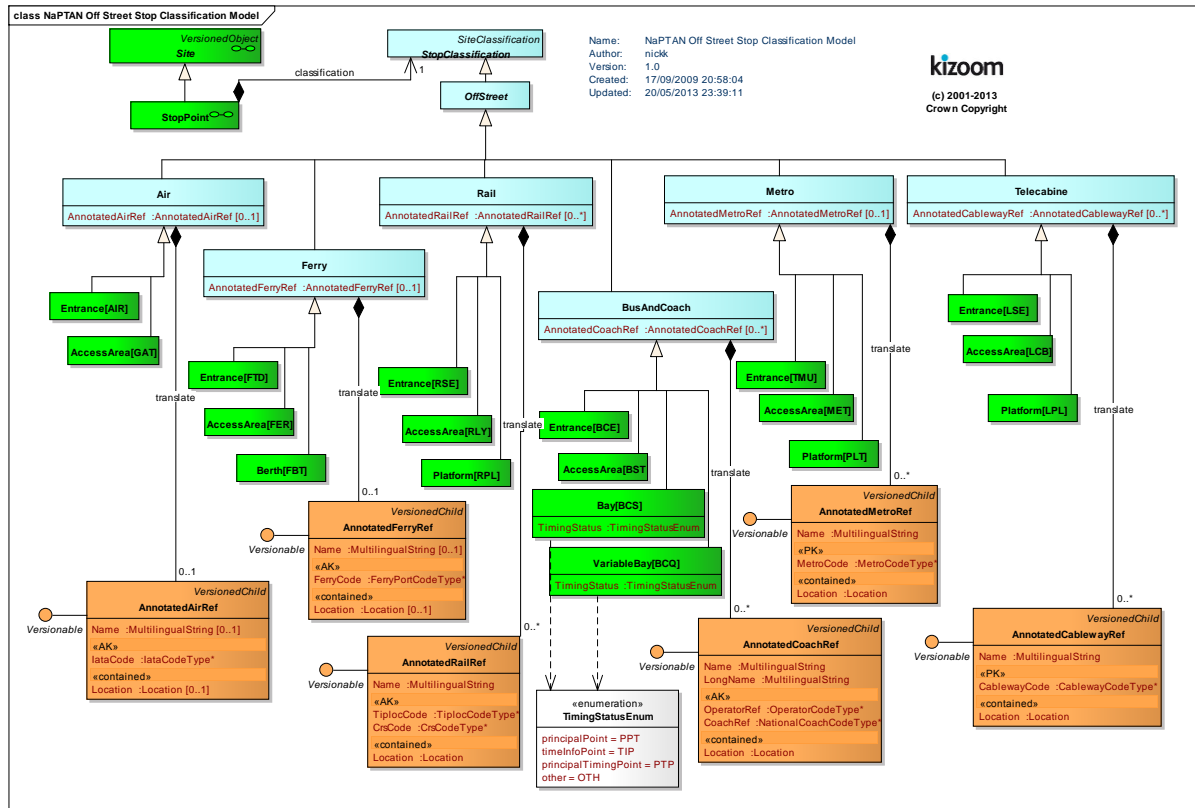

Figure 3-18 – UML Diagram of NaPTAN Off-Street Stop Point Types

Figure 3-19 shows further details for NaPTAN on-street stop types.

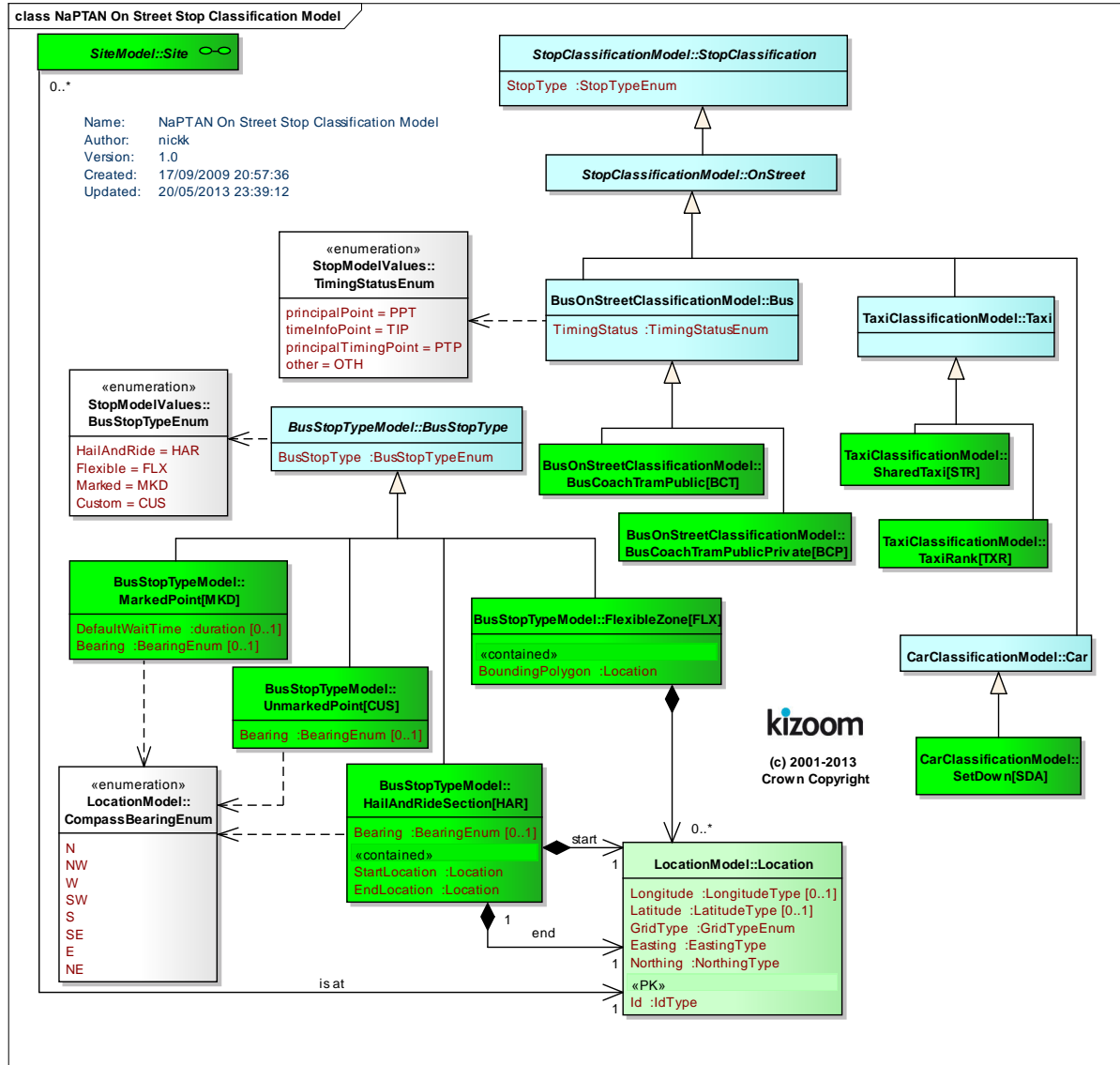

Figure 3-19 – UML Diagram of NaPTAN On-Street Stop Point Types

3.3.3 NaPTAN Stop Accessibility

The **StopAccessibility** element describes the accessibility properties for a stop (Figure 3-20). These may include

- Classification of the stop with an overall assessment for accessibility and a basic classification of its accessibility for wheel chairs, step free use, lift free use, escalator free use.
- The type of assistance needed to use the stop and the **DayTypes** and **Timebands** when it is available. Note that accessibility depends on the type of vehicle as well as the stop. For rail services this will typically be a fixed property of the stop. For bus services it may vary according to the vehicle type. A default indication can be given as to whether most services at the stop are accessible or not.
- Information about the **Operator** through which booking is done. . Accessibility booking details for an operator can be exchanged through the *TransXChange* schema.
- Information about access to vehicles or trains at the stop, for example the type of wheelchair allowed (pushed, motorized, mobility scooter etc). In addition some quantitative values on accessibility, such as gap to platform, number of steps, may also be captured.

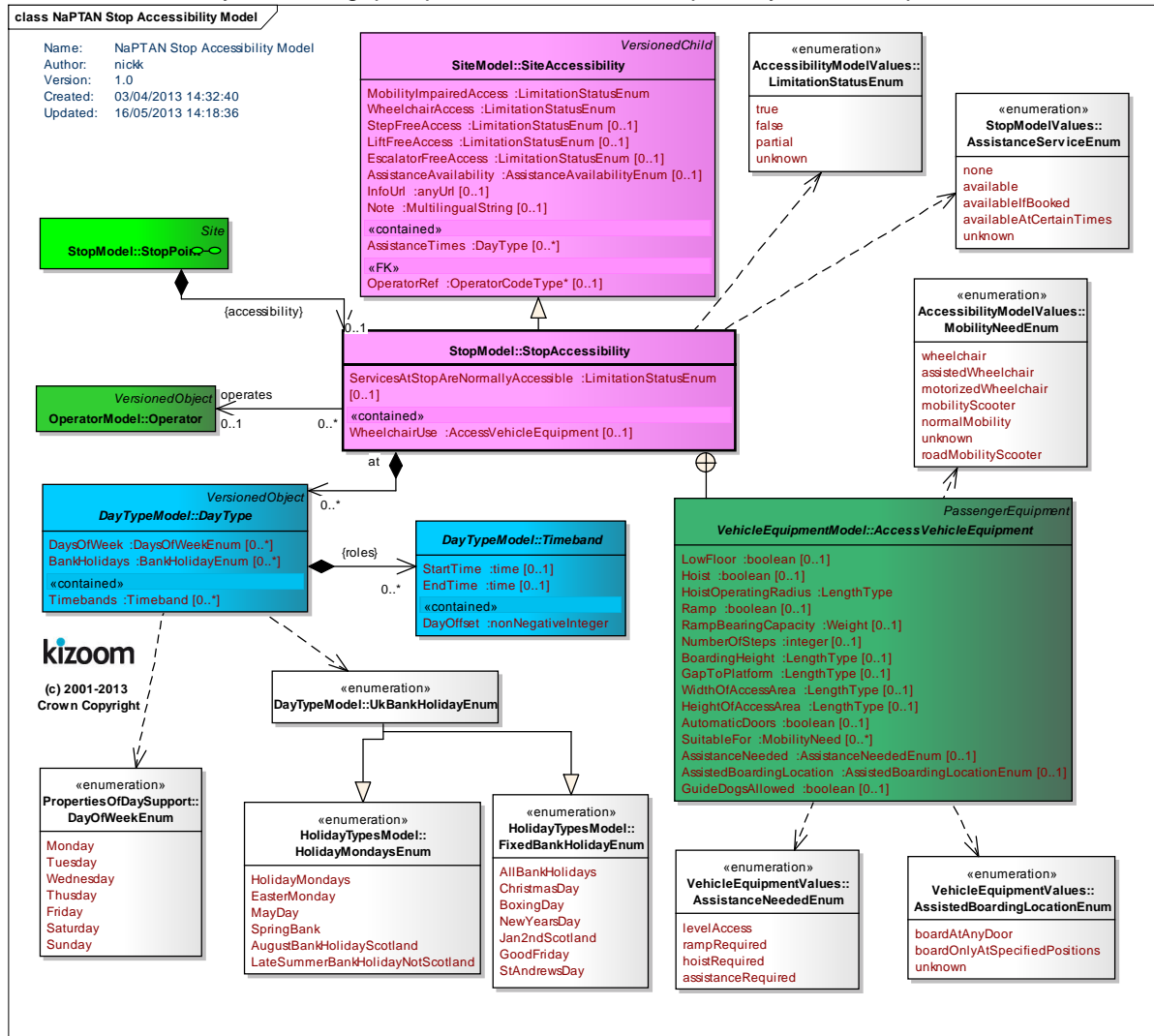

Figure 3-20 – UML Diagram of NaPTAN StopAccessibility

3.3.4 NaPTAN Networks and Tariff Zones

A **Network** defines a named Transport system for which **TariffZones** can be defined (Figure 3-21). **StopPoint** instances may be associated with one or more of these zones. Each **Network** is associated with an **Administration Area**. The area code '970' is reserved for centrally defined Networks.

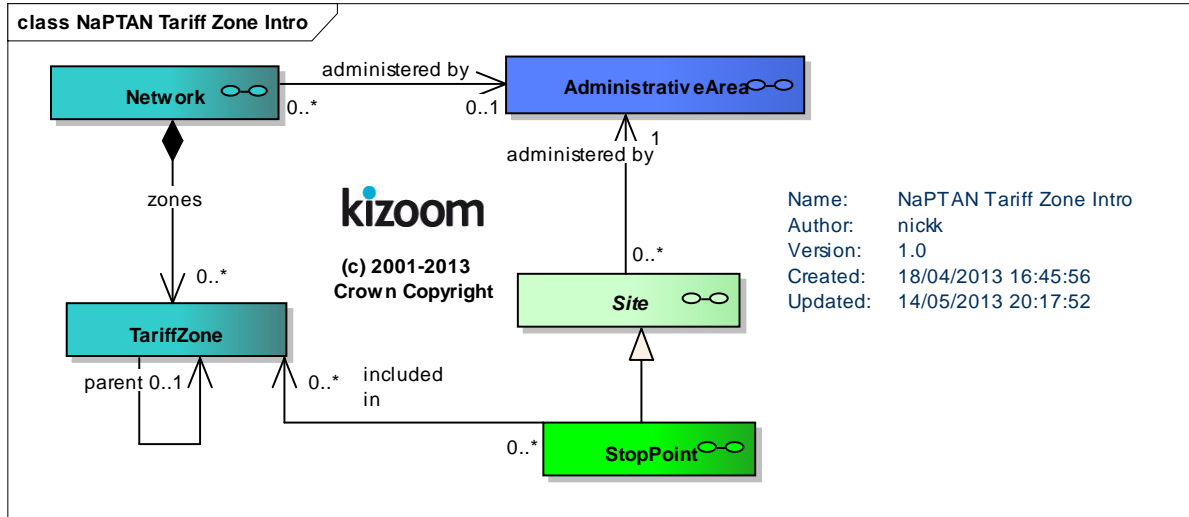

Figure 3-21 – UML Diagram of NaPTAN TariffZones - Overview

3.3.4.1 NaPTAN Tariff Zone details

Figure 3-22 shows the properties of the **Network** and **TariffZone** elements.

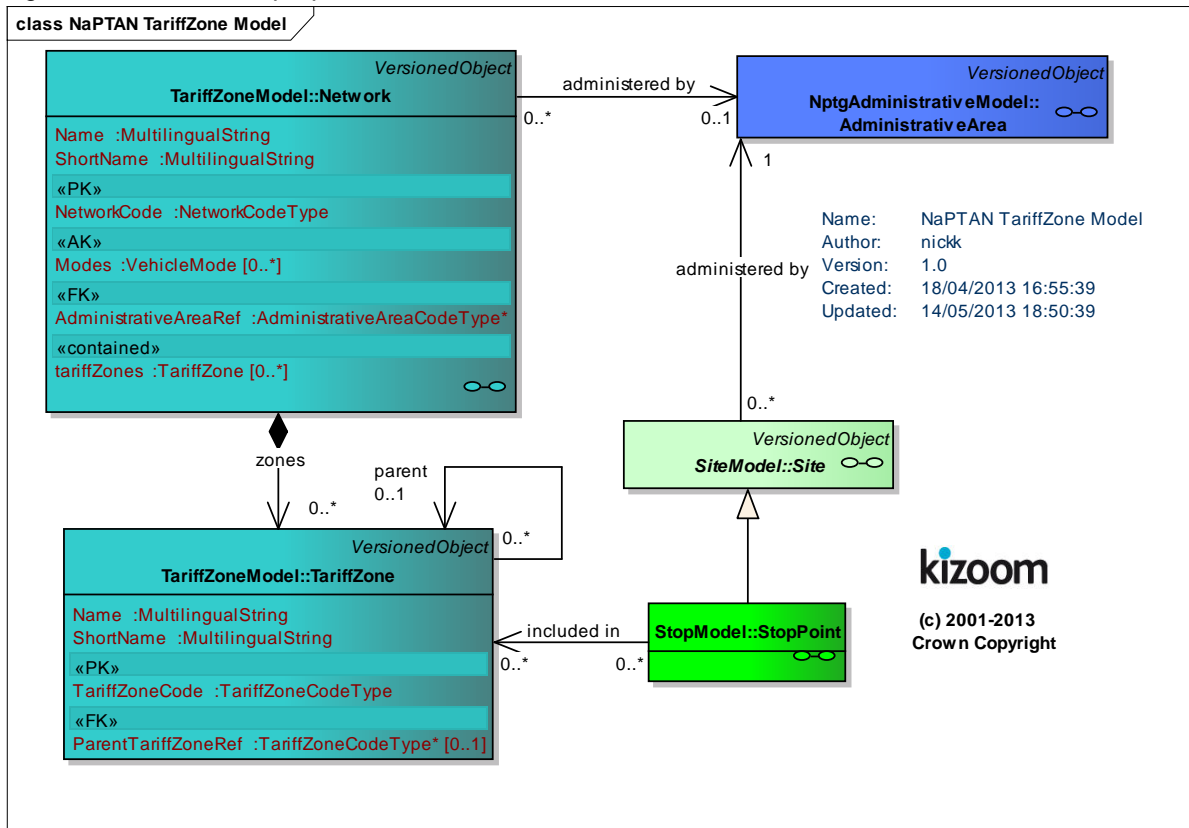

Figure 3-22 – UML Diagram of NaPTAN TariffZones – Details

3.3.1 NaPTAN Points Of Interest

A **Point of Interest** defines a named place to which people may wish to travel. It may have designated **Entrances** and destination points (**EndArea**) within it. It may also have **SiteAccessibility** properties.

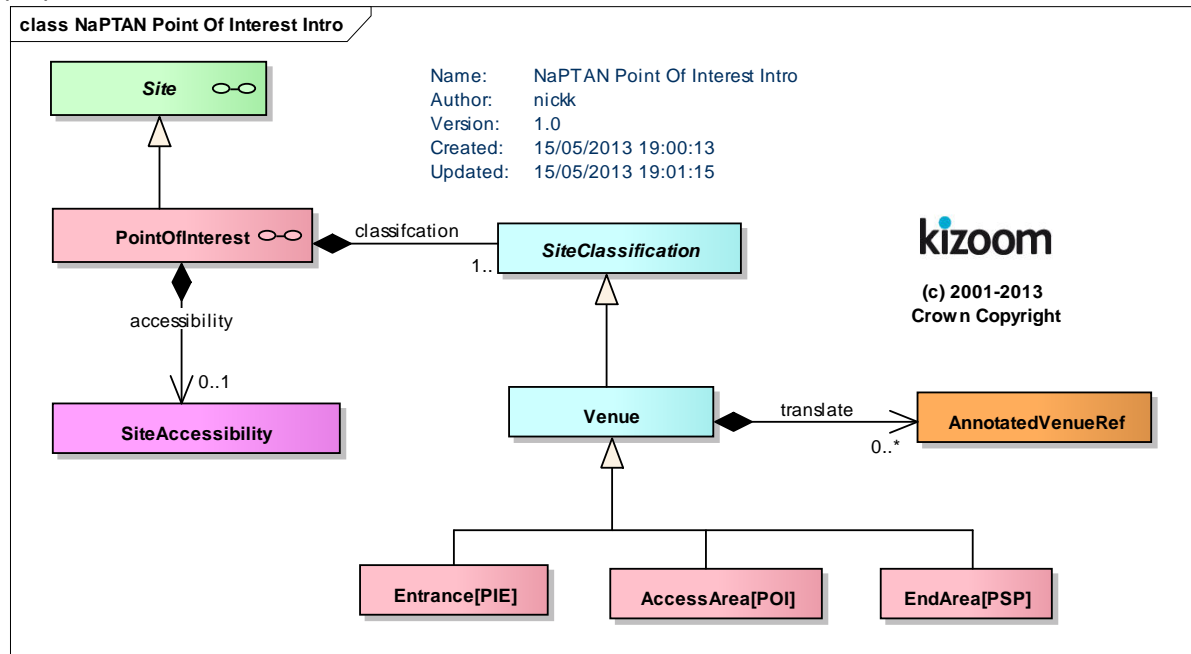

Figure 3-23 – UML Diagram of NaPTAN PointOfInterest - Overview

3.3.2 NaPTAN Point Of Interest details

Figure 3-22 shows the properties of the **PointOfInterest** elements.

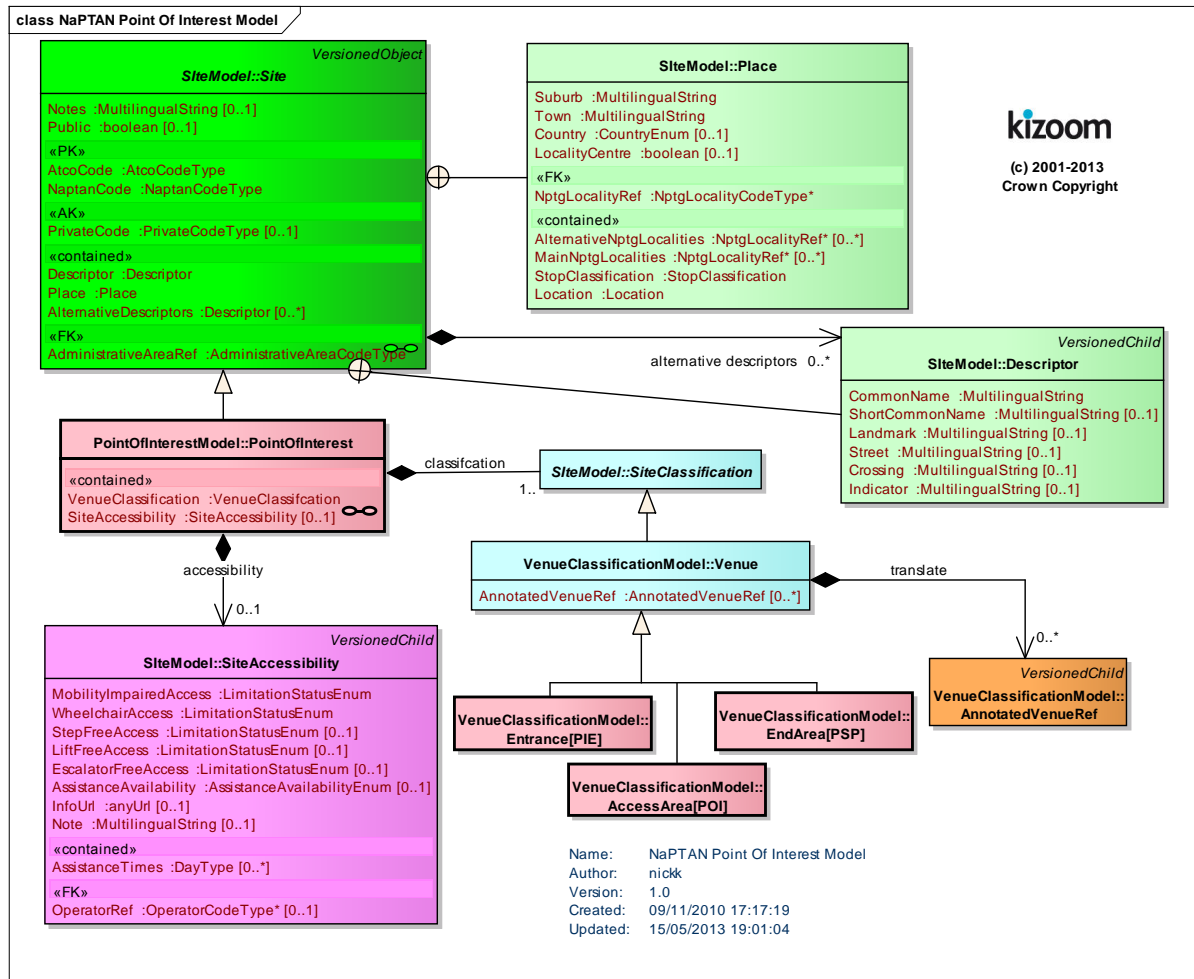

Figure 3-24 – UML Diagram of NaPTAN PointOfInterest - Details

3.3.2.1 PointOfInterest Types

PointOfInterest instances are classified by as either entrances (PIE) , Areas (POI) or end points (PSP).

3.4 NaPTAN Element Hierarchies

3.4.1.1 NaPTAN Stop Element Hierarchy

Figure 3-25 shows the Class hierarchy for the NaPTAN stop elements. **StopPoint** & **Stop Area** are versioned elements. **StopAvailability**, **StopAreaRef** & **Descriptor** are child elements.

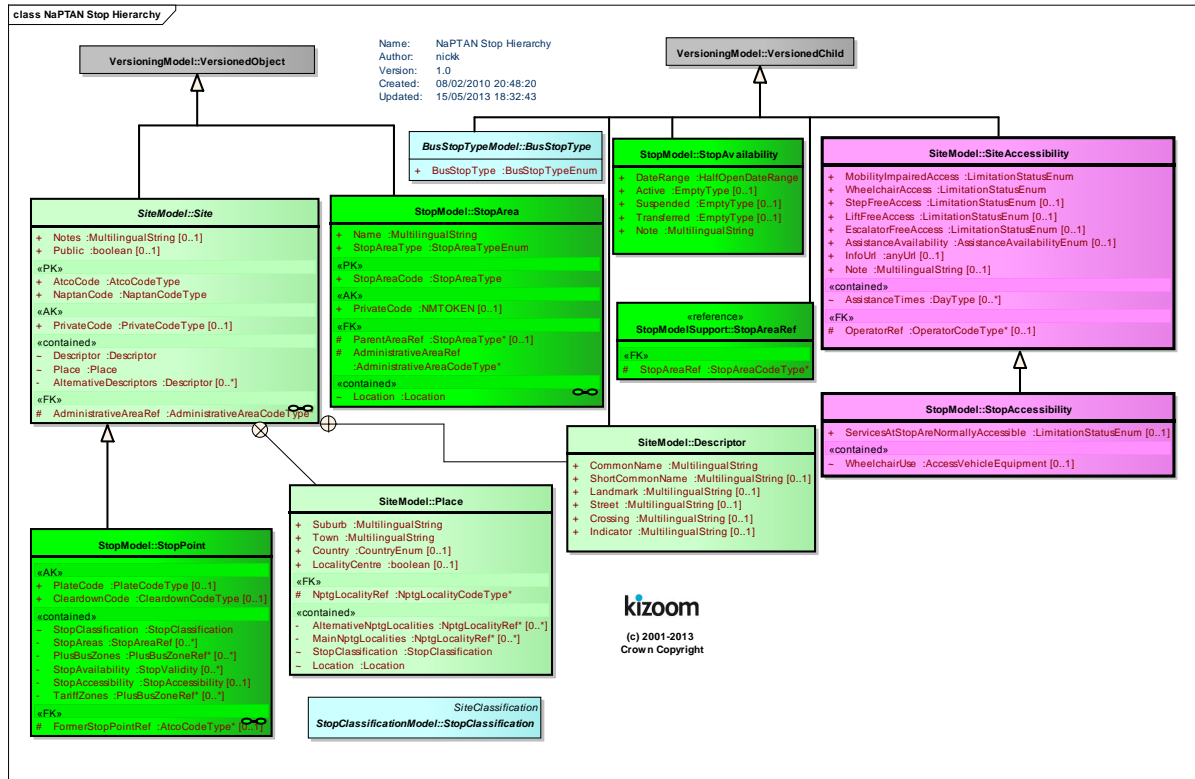

Figure 3-25 – UML Diagram of NaPTAN Stop Hierarchy

3.4.1.2 NaPTAN TariffZone Hierarchy

Figure 3-25 shows the Class hierarchy for the NaPTAN elements. **Network & TariffZone.**

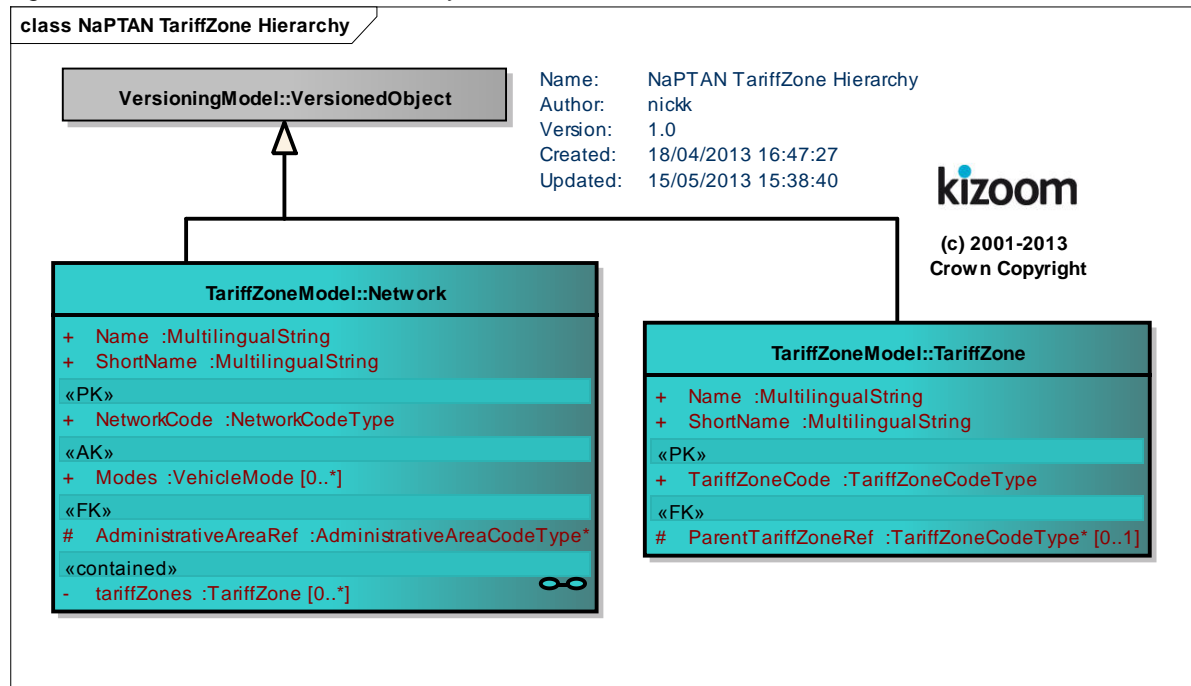

Figure 3-26 – UML Diagram of NaPTAN TariffZone Hierarchy

3.4.1.3 NaPTAN PointOfInterest Hierarchy

Figure 3-25 shows the Class hierarchy for the NaPTAN **PointOfInterest** elements.

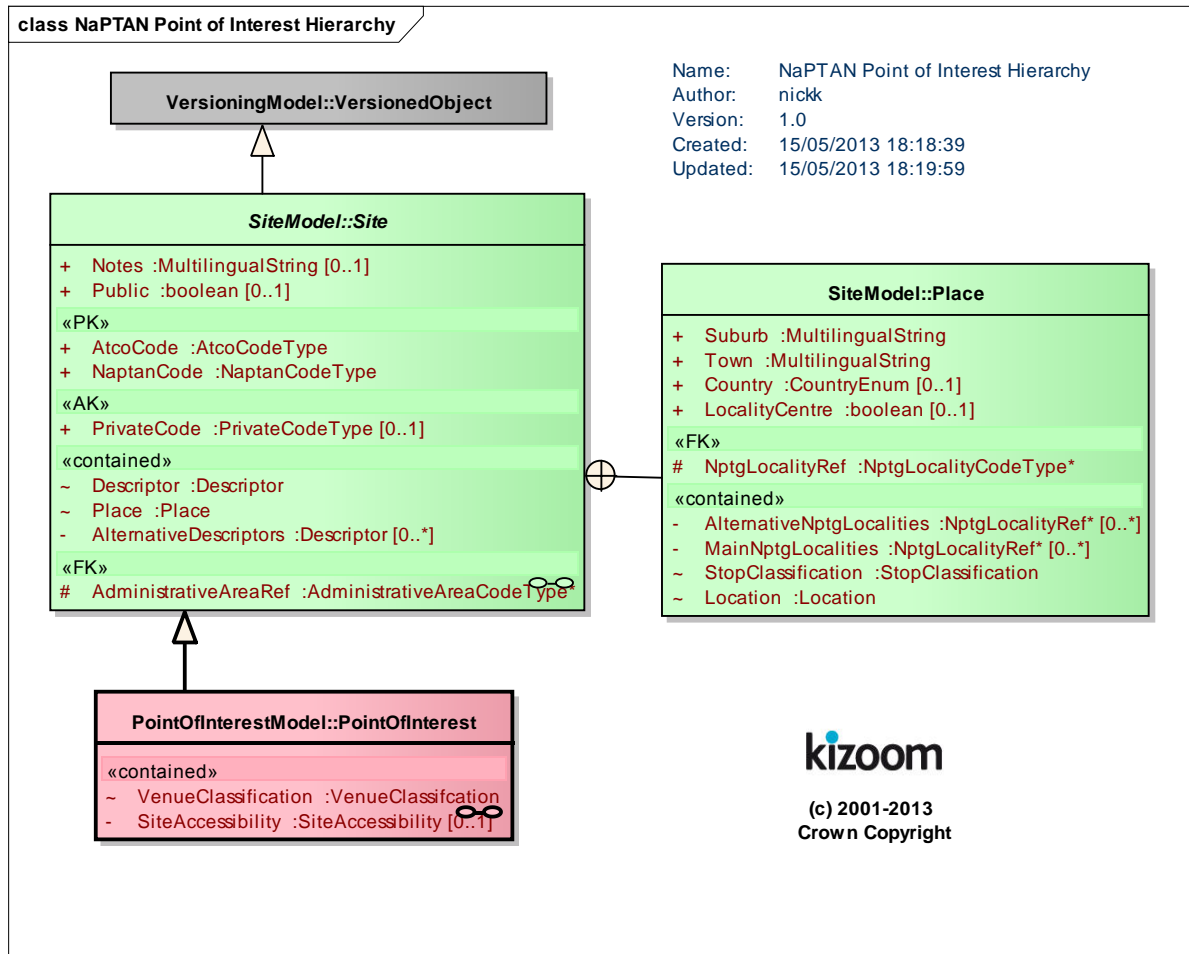

Figure 3-27 – UML Diagram of NaPTAN PointOfInterest Hierarchy

3.4.1.4 NaPTAN Data Types

Figure 3-28 shows the data types used in the *NaPTAN* elements that are additional to those of *NPTG*.

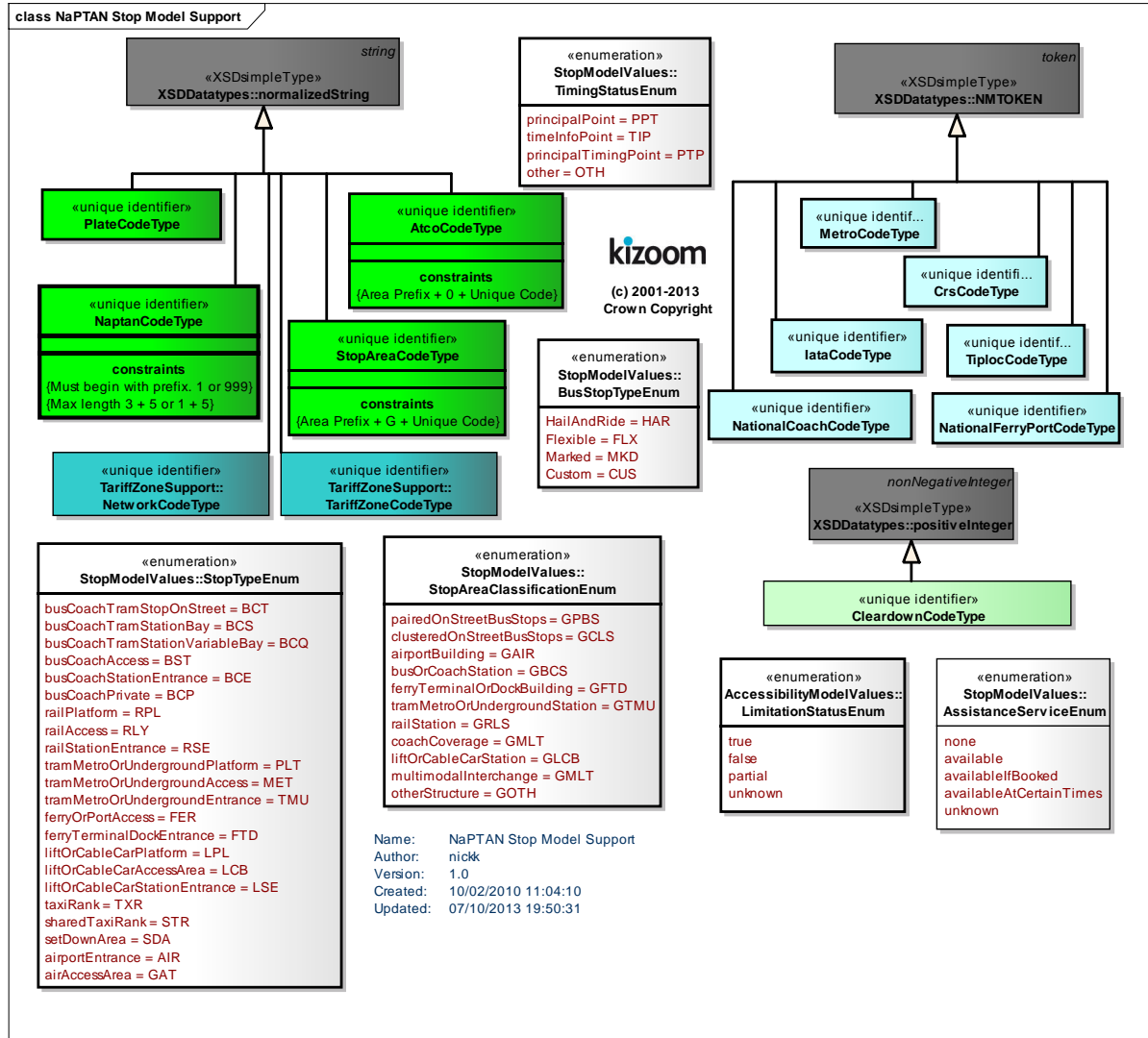

Figure 3-28 – UML Diagram of NaPTAN Data types

3.5 Populating the NaPTAN Database

When entering data into the *NaPTAN* model, as for the National Gazetteer, care needs to be taken in choosing, naming and grouping stops and stop areas so as to populate the model in a way that accurately reflects the way real-world places are perceived by users, and so that the relationships described between them are useful for the intended computational purposes. Consideration should be given to how locality name and stop name complement each other, as they may often be used in combination. For example, when applications such as journey planners present lists of stop names for users to choose from, the locality name may be combined with the stop name to give an appropriate context within which to recognise the stop, e.g. to distinguish '*Cosham, High Street*' from '*Farnham, High Street*'. Furthermore, in order to simplify the choosing of destinations for users, for some applications' engines may aggregate a number of separate but physically related stops into a single 'place', using stop name, location and semantic information from the underlying *NaPTAN* data to derive the appropriate associations. See the examples in Chapter 8.3 for some illustrations.

Another consideration is who is responsible for allocating different types of stops. Most stops are allocated and managed strictly by the administrative area of the topographical region within which they lie.

- Certain types of stops, notably rail, metro, ferry and air access areas, are issued centrally by special administrative areas with a national scope, such as for National Rail and National Metro, as indicated by a **National** subelement on the Administrative Area - such areas also have AtcoCode values beginning with '9nn').
- Where the boundary goes down the middle of the road, an agreement may be made between neighbouring authorities that stops on both sides of the road will be controlled by a single authority, just as highway maintenance on that road is done normally by one of the two relevant authorities, by agreement.

3.5.1 Choosing NaPTAN Points

Table 3-6 above shows the various *NaPTAN* stop types.

On-Street PTANS are represented as points:

- For individual on-street **Bus Stops** (also **Coach Stops**), there should be a *NaPTAN Bus* stop point for every physical stop; even if a stop is the unmarked pair to another stop, it should always have its own separate *NaPTAN* identifier and definition (of type '*BCT*') located at its physical position.
 - **StopArea** elements are used to group individual poles into larger groupings such as pairings (of type '*GBPS*') and on-street clusters (of type '*GCLS*') (see below).
- For **Coach Stops**, a **StopArea** of type '*GCCH*' can be used to associate the stop with Coach Service coverage. '*GCCH*' stop areas have a stop area code (900G) and are allocated centrally.
- For **Taxi Ranks**, there should be a *NaPTAN* stop point for the head of the taxi rank, of type **Taxi** ('*TXR*'), or **SharedTaxi** ('*STR*') if an official taxi sharing scheme operates from the rank.

For stations, termini and other interchange facilities, there should be an individual *NaPTAN* stop point for each "entrance" from the public thoroughfare to the facility, and another **AccessArea** stop point instance for the "access side": All stops should have the same **CommonName**, with a different **Indicator** value to distinguish them if necessary.

- For **Airports**: For each terminal, there should be a *NaPTAN Entrance* point for each main area of check-in desks (of type '*AIR*'), and another single **AccessArea** point to represent the "air-side" (of type '*GAT*'). Entrance records are provided by the relevant Local Administrative Area.
 - A **StopArea** element (of type '*GAIR*') should be used to group the air entrances, access area, and any other connecting stop points such as taxi ranks and individual bus stops around the terminal.
 - The Access Area ('*GAT*') points will be provided centrally (they will have identifiers beginning with 920) and do not need to be provided by other administrative areas.

- For **Ferry Terminals and Ports**: There should be a *NaPTAN Entrance* point for the main entrance gate to the docks or ferry terminal (all of type 'FTD'), and each secondary entrance (also of type 'FTD'), and another single **AccessArea** (of type 'FER') point to represent the general area berths from which the ferries depart. Entrance records are provided by the relevant Local Administrative Area.
 - A **StopArea** element (of type 'GFTD') should be used to group the ferry entrances, access area, and also any other connecting stop points such as taxi ranks and individual bus stops.
- For **Rail Stations**: There should be a *NaPTAN Entrance* stop point for the main entrance to the station (of type 'RSE'), an additional stop point for each secondary entrance (also of type 'RSE'), and another to represent the "track side", that is the main area of public access to the platforms (of type 'RLY'). Entrance records are provided by the Local Administrative Area.
 - The main entrance should be the primary *NaPTAN* stop point, i.e. be encoded with a 0 as the last digit (Secondary entrances have non-zero digits). All entrances should indicate their nature in the indicator text e.g. 'main entrance', 'side entrance'.
 - The **AccessArea** ('RLY') and **RailPlatform** ('RPL') points will be provided centrally (they will have identifiers beginning with '910') and do not need to be provided by other administrative areas.
 - A **StopArea** element (of type 'GRLS'), provided centrally, should be used to group the rail entrances, access area, and any other connecting stop points such as taxi ranks and individual bus stops.
- For **Bus and Coach Stations**: There should be a *NaPTAN Entrance* point for the main entrance (of type 'BCE'), and each secondary entrance gate (also of type 'BCE'). There may be a single **AccessArea** point (of type 'BCQ') to represent the general bays from which the buses depart. There may additionally or instead also be one or more specific **Bay stop** points (of type BCS) if individual poles are identified. All records for Bus and Coach Stations are provided by the Local Administrative Area.
 - A **StopArea** element (of type 'GBCS') should be used to group the station entrances, access area and any other connecting stop points such as taxi ranks and individual bus stops.
- For **Metro & Underground Stations**: There should be a *NaPTAN Entrance* point for the main entrance to the station (of type 'TMU'), and each secondary entrance (also of type 'TMU'), and another single **AccessArea** point to represent the "rail side", that is the main area of public access to the platforms (of type 'MET'). Entrance records are provided by the Local Administrative Area.
 - A **StopArea** element (of type 'GTMU') should be used to group the station entrances, access area, and any other connecting stop points such as taxi ranks and individual bus stops.
 - The **AccessArea** ('MET') and Metro **Platform** ('PLT') points will be gathered locally, but compiled and entered centrally.
- For **Tram Stops** Tram stops are treated as stations. There should be a *NaPTAN PLT* stop point for every physical platform, located at its physical position. And a **PLT** stop to represent the pair.
- For **Telecabine** (Lift & Cable Car Stations): (+NaPT v2.4) There should be a *NaPTAN Entrance* point for the main entrance to the station (of type 'LCE'), and each secondary entrance (also of type 'LCE'), and another single **AccessArea** point to represent the "lift side", that is the main area of public access to the platforms (of type 'LCB'). Entrance records are provided by the Local Administrative Area.
 - A **StopArea** element (of type 'GLCB') should be used to group the lift station entrances, access area, and any other connecting stop points such as taxi ranks and individual bus stops.
 - The **AccessArea** ('LCB') and Metro **Platform** ('LPL') points will be gathered locally, but compiled and entered centrally.

The NaPTAN 'Transport side' stops ('GAT', 'FER', 'RLY', 'MET', 'LCB' areas, and 'FBT', 'RPL' and 'PLT', 'LPL' access points) represent the boarding points to transport vehicles within the station or

interchange building. At present FTD can also be used in the absence of FBT elements at Ferry Terminals.

3.5.2 Allocating an AtcoCode for a NaPTAN Stop Point

The **AtcoCode** is intended to be unique for a given stop point within the UK. The number can be regarded as an arbitrary Universal Identifier, though in practice the prefix part is reserved to specific ranges so as to manage the distributed concurrent allocation of unique codes by different stakeholders. The **AtcoCode** has a general form of: *Database prefix* [3] + *Flag* [1] + *Local reference* [up to 8 alphanumeric characters], where:

1. The *Database prefix* is the **AtcoAreaCode** of the **AdministrativeArea** responsible for managing the stop (which includes special values for rail stations, coach locations, ferry ports and airports).
2. The *Flag* normally has a value of '0'. Historically '1' was used to encode stops belonging to another administrative area – this is not now needed so its use within NaPTAN 2 constitutes an error.
3. *Local reference* is an identifier of the stop, unique within the scope of the **AtcoAreaCode**.
 - **Rail Station Entrances.** The designated form is 'AAA0XXXXXXn' where AAA comprises the **AtcoAreaCode**, '0' is a fixed flag, XXXXXX is the Network Rail TIPLOC code (generally alphabetic, capitalised, up to seven characters) for the station, and *n* is a zero character for the main entrance, and a sequence number for the other entrances. For example, '4000FARNHAM0', '4000FARNHAM1'.
 - **Coach Station Entrances.** The preferred form of number for Coach station entrances is AAA0YYYYYn where is the **AtcoAreaCode** of the **AdministrativeArea** responsible for managing the stop, '0' is a fixed flag, YYYYY is the National Coach code (5 digit numeric) for the coach station, and *n* is a zero character for the main entrance and a sequence number for the other entrances.
 - **Transport side Access Areas.** The stop point codes of the 'Transport side' stops (GAT, FER, MET, RLY, and FBT, RPL, PLT) are assigned centrally from special national prefixes ranges beginning with '9'. The numbers of all other points begin with a local area prefix. For example, '4000FARNHAM0'.
 - **OnStreet Stops.** The preferred form of numbers for on-street stops is AAA0YYYYYYY where AAA is the **AtcoAreaCode** of the **AdministrativeArea** responsible for managing the stop. '0' is a fixed flag. YYYYYYY is a unique locally-allocated code of up to 8 alpha-numeric characters

3.5.3 Allocating NaPTAN (SMS) Codes for NaPTAN Stop Points

NaPTAN allows a short code to be specified for each stop, the **NaptanCode**. This is intended as a unique reference for use in public facing systems such as SMS and web query apps.

The NaPTAN short code is distinct from the ATCO code (the latter is in effect a system identifier). A NaptanCode can only be used once and cannot be reused.

3.5.3.1 Mandatory NaPTAN Code features

In order to achieve nationwide uniqueness, a **NaptanCode** has a systematic structure.

- Codes are made up of an area prefix and a suffix, ensuring they are unique at a national level.
- Each Prefix is unique within the UK and assigned to a specific area.
- The prefixes are normally three characters (See table at end) but London is treated as a special case and uses a single digit - '1'.

Codes should be displayed with their prefixes so that they can be disambiguated on a national level.

3.5.3.2 Optional NaptanCode features

For usability on the keypad of a Mobile device, a number of additional constraints are recommended and Codes issued for most areas of the country follow these rules. However these are optional:

			Rationale
R1	Avoid repeating sequences of digits with a number, so that no two consecutive characters/digits require the same key	(e.g. ' <i>leibaba</i> ', or ' 16747 ', but not ' <i>leiaabbcc</i> ' or ' <i>1-22334</i> ').	Avoids common keying errors
R2	Avoid the use of '0' or '1' in numbers (except for the London prefix).	e.g. ' <i>472913</i> ', but not ' <i>101010</i> '.	Avoids common keying errors and confusion between 0/O and 1/I
R3	Present codes as alpha8 [1] characters synonyms rather than numbers (this requires adherence to R2). (In Scotland numeric rendering is generally used, in UK alpha8)	E.g. <i>234</i> , ' <i>leiadh</i> ', rather than ' <i>lei234</i> '.	Easier on a mixed keypad
R4	Meaningful letters are chosen for the prefix three digits that indicate area.	E.g. <i>Lei=Leicester</i> , <i>man=Manchester</i> etc.	More memorable
R5	Codes may be of variable length. But should be between five and seven characters including prefix		More memorable

Table 3-7 – Rules for SMS codes

1. The Alpha8 characters are the eight letters shown first on a mobile keypad (adgjmtw). Thus for example '234', 'adh', 'bfi' and 'ceg' (and any other permutation of abc + def + ghi) all encode the same number. The use of zero is avoided.

3.5.4 Choosing NaPTAN Stop Areas

The choice and naming of *NaPTAN* stop areas is closely related to the choice of stop points, and the names of related *NaPTAN* stop points and stop areas generally should be the same.

StopArea instances *should only be used to group stops that constitute a localised interchange in easy walking distance*, such as a bus bay, or a pair of opposite bus stops, or the various access points around a rail station. Stop areas must **not** be used to group stops in a wide area arbitrarily. For example, a stop area must **not** be used to create a general stop grouping for all the stops of a town centre; instead a *NPTG* locality for the town centre should be used, and one or more of the stop groups and or stop points be associated with the *NPTG* locality.

As a general rule, a **StopArea** should not group stop points that are more than 250m apart.

Stop areas may be nested in hierarchies to build up a simple interchange description. Stop area names should correspond to the main stop points. For example, the '*Farnham Rail Station*' stop area might include subsidiary bus and stop areas, each containing various stop pairs near the station.

In principle there should be a stop area:

- For every pair of on-street bus poles (*GPBS*).
- For every cluster of on-street bus poles (*GCLS*).
- For every airport (*GAIR*).
- For every ferry terminal or port (*GFTD*).
- For every rail station (*GRLS*).
- For every bus or coach station (*GBCS*).
- For every metro station (*GTMU*).
- For every coach service association (*GCCH*).
- For every lift or cable car station service (*GLCB*).

The **StopArea** for the main travel mode can be used as a parent for the stop areas of subsidiary modes, for example the airport mode can contain a stop area for a rail station that serves the airport.

For a complex interchange, stop areas should be organised into a hierarchy. For example, an Airport might contain child stop areas for its Rail and Metro stations, and several for its bus stops. When assembling **StopArea** instances into a hierarchy, the parent area should be chosen using the relative rankings shown in *Table 3-8*.

	Code	Type	Ranking
Off Street	GAIR	Airport	1
	GFTD	Ferry / Port	2
	GRLS	Rail Station	3
	GTMU	Metro Station	4
	GBCS	Bus or Coach Station	5
	GLCB	Lift or Cable Car Station	6
	GCCH	Coach Stop	7
On Street	GCLS	On-street Bus / Coach stop cluster (more than two stops in the same general location).	8
	GPBS	On-street Bus/ Coach stop pair	9

Table 3-8 – Precedence of StopArea Types

➔ Note that in many cases, additional **StopArea** instances may be inferred by automated processes that augment the manually created *NaPTAN* stop data, for example grouping stop points by (i) by spatial proximity of location, and/or or (ii) semantic similarity of stop point, street name or other descriptor, together with (iii) transport mode. In practice these derived groupings may either be instantiated as actual **StopArea** instances in a database used by the journey planner, or be dynamically recomputed every time a search is made.

For some interchanges, notably rail stations, there may be multiple stop areas describing different parts of the same station (or two different encodings of the same station for historic reasons). If this is the case they should be organised hierarchically with one of them chosen as the “main” root station and others as subsidiary (i.e. **not** using circular references with each one being part of the other).

3.5.5 The Naming of Stop Points and Stop Areas

The allocation of effective names to public transport access points is an important aspect of *NaPTAN*'s purpose.

Whilst rail stations and airports generally have well-known names, some types of PTAN, in particular bus stops, do not always have obvious or intuitive names. The *NaPTAN* **StopPoint** element provides a number of ‘descriptor’ subelements for specifying text descriptions of stops, and *NaPTAN* sets guidelines for populating the elements in a consistent way that will result in useful name phrases in applications, i.e. that enable the use of text based searches to find the stop. See also the examples given later in Part III.

StopPoint descriptors may include:

- A **CommonName**. The simple name for the stop. ‘Simple’ means that qualifiers such as the locality or street name should not be included as a *component* part of the **CommonName** - See ‘Descriptor Atomicity’ below and further comments below. A street name by itself may

however be used as the complete simple **CommonName** of the stop, if that is the most appropriate concept (see "Street Style" later below). Thus for example, a **CommonName** of "Opp St Mary's Upper Street Islington" is non-conformant because it repeats data that is already contained by the other atomic descriptor elements.

- Assuming a **Landmark** style of naming - i.e. that "St Mary's" is the best simple name by which users can recognise the stop, a more conformant representation would be: **CommonName**: "St Mary's"; **Landmark**: "St Mary's"; **Indicator**: "Opp"; **Street**: "Upper Street"; **NptgLocality**: "Islington" – which contains all the information necessary to create a label of "Opp St Mary's, Upper Street, Islington" if needed, but also allows other presentation forms.
- Assuming a **Street** style of naming - i.e. that "Upper Street" is the best simple name, a more conformant representation would be: **CommonName**: "Upper Street"; **Landmark**: "St Mary's"; **Indicator**: "Opp 27"; **Street**: "Upper Street"; **NptgLocality**: "Islington". The nearest **Landmark** should be shown in the data; for example 'Red Lion Public House'. The nearest cross-street (**Crossing**) may also be used as the **CommonName**, for example: 'Folly Lane'.
- An **Indicator** phrase, giving the relationship of the stop to the entity used as the common name, for example 'o/s' i.e. outside, 'behind', etc. The **Landmark**, **Street** or **CommonName** should **not** be repeated in the **Indicator**, as this breaks the principle of descriptor 'atomicity' (see below). Thus, if the **CommonName** is 'Red Lion', the **Indicator** should say just "o/s", and **not** 'Red Lion (o/s)' or 'o/s Red Lion'. Stop numbers, Bay Numbers, etc are also relevant values for the **Indicator**.
- The name of the **Street** on which the stop point lies. The street should always be specified as it provides an alternative search value for finding the stop, and also can provide additional context with which to recognize the stop in stop finders.
- Where both a Point of Interest **Landmark** and a **Crossing** are useful for identifying the stop, the nearest intersection may be given separately using the **Crossing** element.

Additional elements useful for describing the stop include:

- The compass **Bearing** towards which the vehicle is pointing when proceeding down the street past the stop. For example: 'SW'.
- Other descriptive **Notes** about the stop point. These are not public facing – they provide information only to users of the database.

3.5.5.1 Stop Name Uniqueness

NaPTAN **StopPoint** name phrases should be unique within their **NptgLocality** (including any parent or grandparent locality); that is the combination of **CommonName** and **Indicator** elements should be unique.

The descriptor elements that make up stop names should be chosen so that when combined as a 'name phrase', they make a meaningful name that uniquely identifies the stop. The following is one possible order of combination:

<locality> (locality qualifier), <common name> (<indicator>)

Table 3-9 shows some examples of preferred forms

CommonName	Indicator	Locality	Qualifier	Preferred full name
Red Lion	o/s	Blacko	-	Blacko, Red Lion (o/s)
Health Centre	opp	Cosham	-	Cosham, Health Centre (opp)
Tilford Road	-	Farnham	-	Farnham, Tilford Road
Woolworths	opp	Gillingham	Kent	Gillingham (Kent), Woolworths (opp)

Table 3-9 – Examples of Preferred Stop Names

3.5.5.2 Descriptor 'Atomicity'

The different descriptor elements may be combined by applications into name phrases in different ways in different circumstances (see discussion in section 3.5.11.1). Thus the **Landmark**, **Street** and **Indicator** elements should avoid repeating the same proper nouns as content, as this results in verbose and unintelligible compound name phrases: such as 'o/s Red Lion Red Lion (o/s)'.

Similarly, common names should not include the **NptgLocality / Name** or **NptgLocality / Qualifier** name unnecessarily, as again this leads to unhelpful descriptive name phrases when the elements are combined. For example, unnecessary repetition might result in 'Gillingham (Kent), Woolworths Gillingham Kent (opp)'. In the case of rail stations and other termini, it is often the case that the locality name is included in the formally adopted common name (Table 3-10).

CommonName	Indicator	Locality	Qualifier	Preferred full name
Farnham Rail Station		Farnham	-	Farnham, Farnham Rail Station

Table 3-10 – Example Preferred Form for Rail Station Names

As an illustration, *Table 3-11* shows some example name elements for a stop; *Table 3-12* shows some of the different ways that an application might choose to create name phrases from the elements.

	Element	Value
NPTG Locality	AdministrativeArea / ShortName:	Lancs
	NptgLocality / Name:	Blacko
Stop Descriptors	CommonName:	Red Lion
	Landmark:	Red Lion
	Indicator:	Opp

Table 3-11 – Example Name Elements

Possible Derived Names
Red Lion
Red Lion (opp)
Blacko, Red Lion
Blacko (Lancs), Red Lion
Blacko, Red Lion (opp)
Blacko (Lancs), Red Lion (opp)
Gisburn Road, Red Lion
Gisburn Road, Red Lion (opp)
Blacko, Gisburn Road, Red Lion
Blacko (Lancs), Gisburn Road, Red Lion
Blacko, Gisburn Road, Red Lion (opp)
Blacko (Lancs), Gisburn Road, Red Lion (opp)
Red Lion, Blacko
Red Lion, Blacko (Lancs)
Red Lion (opp), Blacko
Red Lion (opp), Blacko (Lancs)
Red Lion, Gisburn Road, Blacko
Red Lion, Gisburn Road, Blacko (Lancs)
Red Lion (opp), Gisburn Road, Blacko
Red Lion (opp), Gisburn Road, Blacko (Lancs)

Table 3-12 – Ways of Deriving Names from Descriptors

3.5.6 Bus Stop Naming Styles

Where there is not an established name for a stop point, a new **CommonName** should be issued. When devising bus stop names, consideration should be given to the finding of the stop by name or partial name in computer-based stop finders; the choice of the best actual common name depends on how the stop name needs to be distinguished from other nearby stops, so that in practice any of the following naming styles may be appropriate:

- 1 **Locality Style:** Name the stop after the locality it serves, for example 'Little Gidding Centre'. In some cases the actual stop name will be a generic name like *Town Centre*. Use of the locality name as a **CommonName** should generally be avoided, as it is not very specific or informative and does not necessarily help users locate the stop with the locality. It is better to use a landmark (e.g. "The Poets Arms") or crossing name (e.g. "High Street") within the locality. The **NptgLocality** name can,

- of course, always be associated with the stop and used in names if appropriate to the context (e.g. "*The Poets Arms, Little Gidding*").
- 2 **Landmark Style:** Name the stop after the landmark or point of interest it serves, for example '*British Museum*', '*Town Centre*', '*St Trinian's School*', '*Boots*', if necessary giving the relation to the landmark as the **Indicator**. For example, '*British Museum*' + '*O/s*'. The landmark may also be the street or crossing name, but a **Street** must also be given. This is a preferred style as it helps users relate stops to their surroundings.
 - 3 If there is no obvious landmark, the name of a road on which the stop lies may be appropriate as long as there is only one set of stops on that road.
 - 3.1 **Street Style:** If the road is short, and has only a single stop or pair of stops, in the street then the name of the road the stop is on may be appropriate as a **CommonName** if there is no other obvious style. This should be with an **Indicator** such as a house number, for example '*o/s 34*'.
 - 3.2 **Crossing Style:** For a longer road on which there are two or more pairs or clusters of stops, then common names based on the nearest cross-street or a landmark are to be preferred, without the name of the road on which they are located (as this is available if needed from the **Street**). The **Indicator** should be set to 'nr' or 'adj' for a stop on the same side of the road, 'opp' for a stop on the other side of the road. This is a preferred style as it helps users relate stops to their surroundings. The use of the **Crossing** rather than the **Street** name as the **CommonName** is preferable as it allows the future addition of more stops in the same street without ambiguity.
 - 4 **Particular Style:** Give the stop a name that does not follow any of the [above styles](#) because of some other local usage: for example: '*Rail Replacement Services*'. This approach should only be used in exceptional circumstances.

3.5.6.1 General Rules for the Names of Stop Points

The following general rules should be applied to stop Common Names and other textual stop descriptor elements:

- **Capitalization:** The preferred style of stop names, place names and street names in NaPTAN is 'title case', that is lower case with the first letter of each significant word in upper case, for example, '*Milton Keynes*'. Prepositions and articles within a name should be in lower case '*Isle of Man*', '*Hole-in-the-Wall Lying-in Hospital*'. '*Kirkby-in-Furness High Street*', '*Cley-next-the-Sea*', **not** '*Cley Next The Sea*'. Prepositions and articles derived from Latin or other languages should not be capitalised either; '*St George's-super-Ely*', '*Poulton-le-Fylde*'.
- **Character Set:** Only uppercase and lower case letters should be used. Specifically the use of digits, non-alphabetic characters, and any punctuation characters other than apostrophes, hyphens and ampersands should be avoided in names. Numbers should be spelt out e.g. '*Seven Sisters*', **not** '*7 Sisters*'. The characters in Table 3-2 must **not** be used as they are disallowed by the schema. The characters in Table 3-3 should not be used but are not currently excluded by the schema. Note that non-letter characters such as ampersand ('&') will need to be encoded as XML entities (e.g. &) within XML content.
- **Hyphenation:** Names should be hyphenated according to the preferred form of usage by residents, for example, '*Dudington-Fineshade*', '*Lawton-Gate*'. Prepositions in some British place names are hyphenated, for example. '*Lilford-cum-Wigestead*', '*Hinton-In-the-Hedges*', '*Laughton-en-le-Morthen*', '*Rhyd-y-Pandy*', '*Ty'n-twr*'. Where there is a choice of usage the hyphenated form is preferred.
- **Use of Periods:** Full stops must not be used within names. For example, use just '*St*' rather than '*St.*'; do not put a final period on names.
- **Use of Commas:** Commas must not be used within names as they are conventionally used to indicate concatenation of elements when formatting names. See section 3.5.11.1 below.
- **Apostrophes:** Apostrophes should be used in accordance with the preferred local usage, and be consistent with the locality name. For example, "*Robinson's end*", "*Cross o' th' Hands*", "*St Mary's*", "*Top o' th' Knowl High Street*".
- **Indicator phrases:** Standard terms of relation should be used in the content of **Indicator**. See Table 3-13 for details of preferred values for **Indicator**.

Group	Indicator term	
	source	normalised
Relation (should appear in front of common-name)	opposite	opp
	opp	
	outside	o/s
	o/s	
	adjacent	adj
	adj	
	near	nr
	nr	
	behind	
	inside	
	by	
	in	
	at	
	on	
	just before	
	just after	
corner of		
Description (should appear after common-name)	corner	cnr
	cnr	
	drt	
	Stop	
	stance	
	stand	
	bay	
	platform	
	entrance	
	main entrance	
	side entrance	
	front entrance	
	back entrance	
	rear entrance	
	north entrance	N entrance
	east entrance	E entrance
	south entrance	S entrance
	west entrance	W entrance
	north east entrance	NE entrance
	NE entrance	
	north west entrance	NW entrance
	NW entrance	
	south east entrance	SE entrance
	SE entrance	
	south west entrance	SW entrance
	SW entrance	
	N entrance	
	E entrance	
	S entrance	
	W entrance	
	arrivals	
	departures	
	Northbound	N-bound
	N-bound	
Southbound	S-bound	
S-bound		
Eastbound	E-bound	
E-bound		
Westbound	W-bound	
W-bound		
NE-bound		
NW-bound		
SW-bound		
SE-bound		

Table 3-13 – Preferred Phrases to Use in Indicator

The words “Stop”, “stand”, “stance”, “bay”, “platform”, “entrance” can be followed by an alphanumeric string to allow for Stop codes e.g. A, 1, A1, 1A, 23, FG, AB27, etc. with the numeric part limited to one or two digits and the alpha part to one or two characters either before or after the numeric – all in an unbroken string (of up to 4 characters).

Words which indicate a relationship (nr, opp, o/s, adj, at etc) can be followed by an alphanumeric string to allow for house numbers (e.g. opp 23, o/s 76a). In this case the numeric component should permit values to 9999, with or without a single following alpha character.

In output systems, stops which have an indicator in NaPTAN which does not match one of the preferred values (including those which do not have an indicator where one is required) should be given a normalised indicator based on the value of the bearing for the Stop – so in this situation a Stop with a bearing of “N” will have a normalised indicator of “N-bound”.

- **Use of Ampersand:** The ampersand character ‘&’ is preferred to the word ‘and’ as a conjunction, for example, ‘*Bat & Ball*’.
- **Use of Abbreviations:** Abbreviations should be avoided, for example ‘*Great Missenden*’ and **not** ‘*Gt Missenden*’, ‘*North Wootton*’ **not** ‘*N.Wootton*’. The exception to this is the prefix for ‘*Saint*’, where ‘*St*’ should always be used, without a full stop, for example ‘*St Ives*’, ‘*Ilketshall St John*’. Although names and other text descriptors in the *NaPTAN* database can be up to 48 characters long, it is preferable if they can be kept to less than 24 characters.
 - Where needed, standardised abbreviations should be used. See Appendix 15.4.
- **Spacing:** Words should be single spaced.
- **Use of forward Slash:** The uses of forward or backwards slashes or vertical bars in stop common names to denote alternatives must be avoided. Alternative names should be specified explicitly as separate descriptor entries.
- **Stop types :** A stop type should not be referred to in either the **CommonName** or the Indicator for a stop. If a stop is a Hail-and-Ride (HAR), an unmarked (CUS) or a flexible zone (FLX) stop type, then this information is available from the stop type field and it is for output systems to interpret this data and to add to its display (Hail-and-Ride), (unmarked) or (Demand Responsive Zone) as relevant or whatever else might be appropriate to the specific output system.

3.5.7 Naming Of Particular Types of Stop

3.5.7.1 Naming of Rail Stations

Rail station names should include the suffix phrase ‘Rail Station’ in their names, for example, ‘*Ashwell & Morden Rail Station*’.

Rail station names should use the definitive names used on the National Rail Website <http://www.nationalrail.co.uk/>.

3.5.7.2 Naming of Airports

Airport stops should have the word ‘Airport’ or ‘Terminal’ in their name, for example, ‘*Southampton Airport*’, ‘*Heathrow Terminal 1*’ + ‘*London Heathrow Terminal 1*’.

Airport names should be the definitive IATA name. Other names may be specified as alternative names.

3.5.8 Naming of Stop Areas

Stop area names should be the same as the common names of the main stops in the stop area.

3.5.9 The Classifying of Bus Stops and Other PTANs

The *NaPTAN* model provides a number of ways of classifying the stop:

- Whether the stop is *active* or *inactive*. See discussion in 11.2.6. The modes of transport it supports (bus, rail etc).
- For bus stop point there are additional attributes:
 - Whether the stop is marked or not (For example many rural bus stops are not).
 - Whether it is normally a timing point in a schedule.

3.5.10 Associating Stop Points and Stop Areas with NPTG Localities

Every **StopPoint** has a primary **NptgLocality** within which it is situated. The *NPTG* locality specified for a stop point or stop area should be the most specific (i.e. the most precise as to area) available. For example, use a suburb of a city in preference to the whole city.

In addition **StopPoint** instances may also be associated with a number of alternative **NptgLocality** instances

Certain major **StopPoint** instances may further be associated with particular **NptgLocality** instances as the main stop points for the locality; for example, the rail stations. Main stop points are normally central, but do not have to be physically contained within the immediate locality – for example the rail station for Norwich is a main stop for the town, but is not located at the centre.

The **Town** and/or **Suburb** on the **Place** element of a **StopPoint** should only be specified if they differ from the names of the *NPTG* locality specified for the **StopPoint**. If they are the same, they will be derived automatically through the reference.

The association of stop areas with an **NptgLocality** is indirect – through the associations of the **StopPoint** instances within the **StopArea**. All stop points in a stop area should be associated with the same primary *NPTG* locality, and also have similar associations as the other stops for any alternative localities.

3.5.11 Geocoding of Stop Points - Location

All *NaPTAN* **StopPoint** instances have a geocode, i.e. a spatial **Location** associated with them that specifies their map coordinates.

- The UK *NaPTAN* database uses OS Grid coordinates and data should be *submitted* geocoded with Grid coordinates. For Eire ITM grid may be used (Irish Transverse Mercator).
- The *NaPTAN* schema supports the exchange of stops with both WGS 84 and grid coordinates, and both are provided in the *distributed* data.

The usage of location depends on the stop point classification (see *Table 3-14*); for on-street points and off-street entrance points, the location should be an exact single point of the doorway or pole. For logical stops representing a zone or access area, the location should be a central point chosen to give a sensible visualisation of the area on a map; and depending on type, may also be accompanied by a more detailed description of the coordinates, as for example for a hail and ride section.

Group	Type	Sub Type	Description	Shape	Location		
On Street	Bus	BCT,	MKD	On-street Bus / Coach Stop.	Point		2.0
			CUS	Custom / Unmarked stop	Point		2.0
			HAR	Hail & Ride zone.	Line	Centre of line	2.0
		FLX	Flexible Zone.	Polygon	Centre of area	2.0	
		BCS		Bus / Coach bay / stand / stance within Bus / Coach Stations.	Point		2.0
	Taxi	TXR		Taxi Rank (head of).	Point		2.0
		STR		Shared Taxi Rank (head of	Point		2.0
	Car	SDA	Setdown and Pick up Area	Point	Centre of area	2.4	

Off Street	Entrance	AIR	Airport Entrance.	Point		2.0
		FTD	Ferry Terminal / Dock Entrance.	Point		2.0
		TMU	Tram / Metro / Underground Entrance.	Point		2.0
		RSE	Rail Station Entrance.)	Point		2.0
		BCE	Bus / Coach Station Entrance.	Point		2.0
		LCE	liftOrCableCarStationEntrance	Point		2.4
	Access Area	GAT	Airport Interchange Area..	Point	Centre of area	2.0
		BST	Bus / Coach Station Interchange Area.	Point	Centre of area	2.0
		FER	Ferry or Port Interchange Area.	Point	Centre of area	2.0
		MET	Underground or Metro Interchange Area..	Point	Centre of area	2.0
		RLY	Railway Interchange Area. .	Point	Centre of area	2.0
		LCB	liftOrCableCarAccessArea	Point		2.4
	Bay / Platform	FBT	Ferry Terminal / Dock Berth.	Point		2.0
		RPL	Rail Platform.	Point		2.0
		PLT	Underground or Metro Interchange Platform..	Point		2.0
		BCS	Bus / Coach bay / stand / stance within Bus / Coach Stations.	Point		2.0
		BCQ	Bus / Coach Station Variable Bay.	Point		2.1
		LPL	liftOrCableCarPlatform	Point		2.4

Table 3-14 – Stop Point Location Types

3.5.11.1 Considerations for Effective Naming of Stops in Journey Planners:

Some useful insight into the effective naming of stops can be obtained by considering how stop names are used in the software interfaces that interact with end users, as for example in a journey planner stop or place finder.

3.5.11.2 Presentation of Stop Names in Disambiguation Lists

When displayed in lists in place finders, stop names will typically be prefixed by a locality name in order to provide users a context within which to recognise the common name, and to distinguish the stop name from other similar names. For example, if you enter 'High Street' without a town name, there might be many possible candidates, so the locality may be added as a prefix, 'Oxford, High Street'.

When displayed in a list in a user interface, disambiguated names will normally have a general format that is made up of several elements:

{NPTG Locality Name (+Optional Locality Qualifier)}+ {Stop Common Name} {Stop Indicator}

Note however, that different application user interfaces may vary the order in which they use to combine the elements into a 'name phrase' for presentation; for example the order 'Stop Name + Locality Name + Stop type' may also be used, or in other circumstance the locality name and/or qualifier may be omitted; for example on a map, where the context is already given.

Figure 3-29 shows an example from the South East region journey planner using Locality Name + Stop Name for bus stop points (with 'stop' appended on the end. Thus for instance, the 'Packhorse' **StopPoint** in the **NptgLocality** 'Gerrards Cross' would appear as: 'Gerrards Cross, Packhorse (stop)'.

Note the example demonstrates the use of fuzzy phonetic matching to tolerate common types of spelling errors in the enquiry input ('gerrods cross').

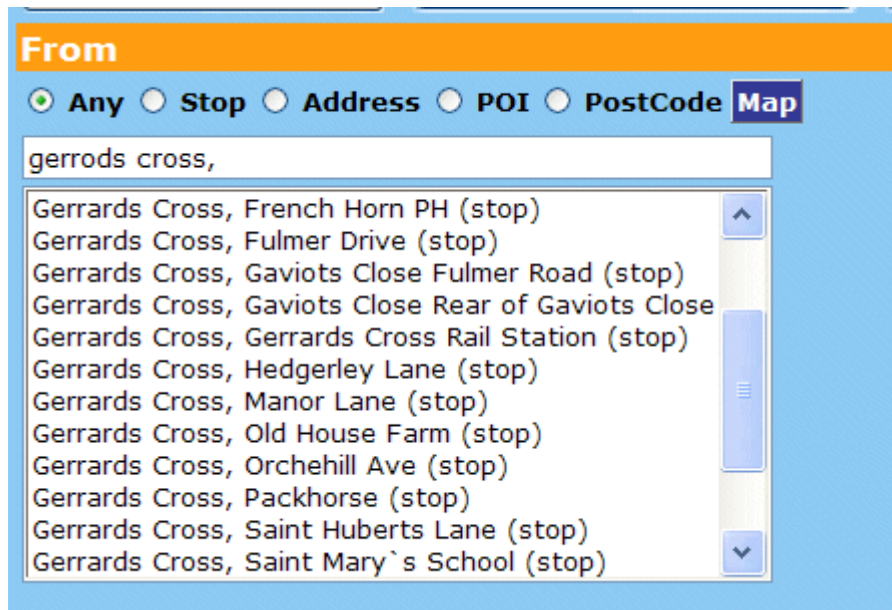

From the SELTA region journey planner stop finder, Courtesy MDV

Figure 3-29 – Example of Stop Names in a List

The locality qualifier can be used in applications if the locality needs to be distinguished from other similarly named localities. For example, the ‘*Packhorse*’ **StopPoint** in the **NptgLocality** ‘*Ashford*’ would appear as: ‘*Ashford (Kent), Packhorse (stop)*’.

The use of hyphens can facilitate the intelligibility of names, for example ‘*Sutton-on-the-Forest, Huby*’ is slightly easier to read and recognise than ‘*Sutton on the Forest, Huby*’.

The avoidance of embedded commas in names is especially important; ‘*On the Forest, Sutton, Huby*’ is considerably harder to interpret. Similarly trailing articles as in ‘*Dunks, The, High Street, The*’ give rise to difficulties.

As a further *example*, *Figure 3-30* shows the results of using a place name of ‘*Church End*’ in the Transport Direct Portal Journey planner – the various instances are distinguished by both a qualifier and an administrative area.

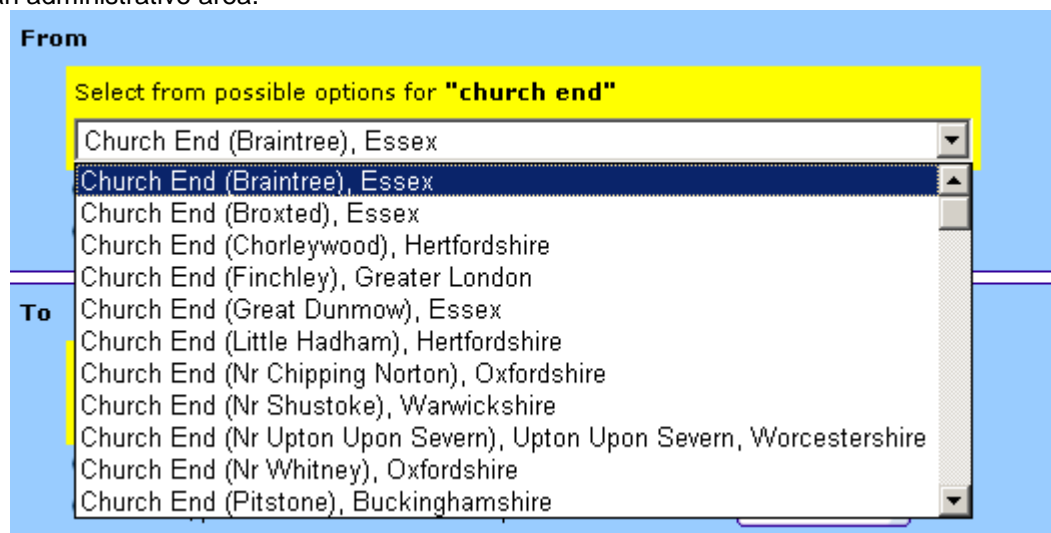

From the Transport Direct Portal Journey Planner – Atos Origin.

Figure 3-30 – Example of Ambiguous Place Names

3.5.11.3 Matching of Stop Names by Stop & Location Finders

When processing input search strings, stop finders will generally:

- Use specific special characters as delimiters (for example comma to mark the end of a locality), or commands (for example '*' for wildcard).
- Ignore extra spaces in names.
- Ignore hyphens and apostrophes.
- Ignore the difference between upper and lower case.
- Understand some common abbreviations.
- Support fuzzy and partial searches, and tolerate some common types of typing and spelling errors.

3.5.11.4 Implications for Stop Naming

We note some particular implications of the use of stop names in software user interfaces for the naming of stops:

- It is preferable if the stop common name does not repeat the locality name unnecessarily -- so as to avoid for example the informationally redundant '*Gerrards Cross, Gerrards Cross Packhorse*'. Applications may always themselves add in the locality if appropriate. However, where the locality name is an integral part of the name, for example '*Tonbridge School*', or '*Farnham Rail Station*', it should be used, even though this might result in some repetition (e.g. '*Tonbridge, Tonbridge School*' or '*Farnham, Farnham Rail Station*').
- The inclusion of separators such as commas in stop names generally makes them harder to interpret in lists.
- Lists may include stops of different types, so including a type phrase ('Rail Station', 'Airport', 'Coach Station') for stop type other than bus stops helps users.
- Simple names ('*Boots*', '*St Mary's Church*', '*Hospital*', '*High Street*'), are preferred to composite names ('*Boots High Street*', '*St Mary's Church Fenham Green*' '*Hospital -Furlong Road*', '*High Street Bus Station*'). Again applications may always themselves add in the locality or other context if appropriate. Where there are two or more stops on the same road, then common names based on the nearest cross-street or a landmark are to be preferred, without the name of the road on which they are located - since this can be obtained from the **Street** element of the database.
- As an exception to this rule it is however useful to include the town name in the names of Rail stations.
- The assigning of correct NPTG localities is very important.
- The consistent use of capitalisation and hyphenation improves intelligibility. Names held in the NPTG database should be in a definitive form and consistent style.
- The preferred way of populating NaPTAN name elements is so as to lead to easily recognizable names when the descriptor elements are combined by applications into a name phrase in a particular order. The preferred order is '*NptgLocality (Qualifier), Common Name (Indicator)*'. In choosing names it is helpful (i) to test them by concatenating the elements in the suggested order and considering the resulting name phrase for sense, and (ii) to compare the name phrase to those of adjacent stops to see if they are helpful in distinguishing the stop from the others.

3.5.11.5 Implications for NPTG Locality Naming

Similarly considerations apply to the naming of NPTG Localities:

- Names should generally be the simple name of the locality.
- It is useful to create distinct elements to represent the central areas of towns and cities. For the names of Town and City Centres, it is useful to include the Town name as part of the name, e.g. '*Shirley Town Centre*', '*Winchester City Centre*'.
- Consideration should be given as to whether a Locality name is unique within the UK, and if it is not, a qualifier should be added.

3.5.12 Populating Accessibility data

NaPTAN model is intended to allow an incremental approach to capturing accessibility data, that is, data may captured to different degrees of detail according to the available resources. An overall assessment should always be provided, with further detail as available.

It should be noted that accessibility depends not just on the stop, but also on the capabilities of the vehicles (e.g. low floor, wheel chair spaces etc.) and services (e.g. assistance) that visit the stop. NaPTAN provides a means of specifying stop related data and also of indicating whether service at the stop is generally accessible or not. However to provide completely accurate information additional data is needed from other sources such as TransXChange 2.5.

3.5.12.1 On Street Stops

Typically the capture of top accessibility data for on-street stops such as bus coach and tram stops is more straightforward than for complex off street sites such as stations and airports, since the stop itself is directly accessible Table 3-15 indicates the relative priority of different elements.

On street stops are normally accessible directly at street level one and may simply be tagged as accessible or not. If all the services that visit the stop are accessible it is useful to tag the stop further, for example with low floor/hoist, wheelchair/mobility scooter.

Any boarding assistance service will usually be provided by the driver or conductor so if offered at will be available at all times.

<i>Element</i>	<i>Attribute</i>	Usual value		Note
Stop-Accessibility	MobilityImpairedAccess	true	1	To be specified
	WheelchairAccess	true	1	To be specified
	StepFreeAccess	(true)	2	Usually true
	LiftFreeAccess	(true)	4	Not usually relevant
	EscalatorFreeAccess	(true)	4	Not usually relevant
	AssistanceService	(unknown)	2	Useful
	InfoUrl		3	Useful
	ServicesAtStop-UsuallyAccessible	(unknown)	2	Useful
	Note		3	
DayType	DaysOfWeek		4	Not usually relevant
	Timeband		4	Not usually relevant
	PublicHolidays		4	Not usually relevant
Access-Vehicle-Equipment	LowFloor	true	2	Useful
	HighFloor	true	2	Useful
	Hoist	true	2	Useful
	HoistOperatingRadius		2	Useful
	Ramp	false	2	Useful
	Boarding Height		4	Not usually relevant
	Gap to Platform		5	Not usually relevant
	Width of Access area		4	Not usually relevant
	Height of Access area		4	Not usually relevant
	AutomaticDoors		3	Usually true
	SuitableFor	(unknown)	2	Useful to further characterize wheelchair, mobility Scooter, etc.
	AssistedBoardingLocation	(BoardAtAnyPoint)	5	Not usually relevant
GuideDogsAllowed	(true)	3	Usually true	

Table 3-15 – Populating on-street stops

3.5.12.2 Off street Stops

For off street stops such as stations, access to platforms may involve paths that use steps, lifts or escalators and it is helpful to indicate these. In addition it may be relevant to indicate if the assistance is only available at particular times or needs booking. Table 3-16 indicates the relative priority of different elements.

<i>Element</i>	<i>Attribute</i>	Usual value		Note
Stop-Accessibility	MobilityImpairedAccess	(unknown)	1	To be specified
	WheelchairAccess	(false)	1	To be specified

	StepFreeAccess	(unknown)	1	To be specified
	LiftFreeAccess	(true)	2	Useful
	EscalatorFreeAccess	(true)	2	Useful
	AssistanceService	(false)	2	Useful – may need booking
	InfoUrl		3	Useful
	ServicesAtStop-UsuallyAccessible	(unknown)	2	Useful
	Note		3	
DayType	DaysOfWeek		3	Useful
	Timeband		3	Useful
	PublicHolidays		3	Useful
Access-Vehicle-Equipment	LowFloor	(false)	4	Not usually relevant
	HighFloor	(false)	4	Not usually relevant
	Hoist	(false)	4	Not usually relevant
	HoistOperatingRadius		4	Not usually relevant
	Ramp	(true)	2	Useful
	Boarding Height		4	Useful
	Gap to Platform		4	Useful
	Width of Access area		4	Useful
	Height of Access area		4	Useful
	AutomaticDoors		3	Usually true
	SuitableFor	(unknown)	2	Useful to further characterize wheelchair, mobilityScooter, etc
	AssistedBoardingLocation	(BoardAtAnyPoint)	2	Useful
	GuideDogsAllowed	(true)	3	Usually true

Table 3-16 – Populating off-street stops

If not present the usual value may be inferred according to the mode – see accessibility defaults in Table 6-5 later below.

3.6 NPTG Discovery Model

3.6.1 Overview of NPTG Discovery Model

The *NPTG Discovery* schema provides information for and about various types of public transport travel information system services and covering NPTG localities.

It uses the *NPTG* topography to provide a coverage model to relate available web services to *NaPTAN* stops. Discovery can work in two directions:

1. **Coverage Discovery:** A means of finding out the stops covered by the services available for a give localities or administrative area.
2. **Service Discovery:** A means of finding out the services that cover a specific stop, locality, or administrative area.

3.6.2 Informational Service Elements

Figure 3-31 shows, in UML class diagram notation, the main elements of the *NPTG Discovery* schema.

The coverage elements provide a basic directory of public transport information services available to cover localities.

- The **WebApplications** container element holds instances of:
 - **WebApplication**, A specific capability. Web services may be associated with any or all of a specific **Locality**, an **AdministrativeArea** or a whole **Region**. See discussion under coverage later.
- The **TrustedServers** container element holds instances of:
 - **TrustedServer**: An access point to a web service.
- The **CallCentres** container element holds instances of:
 - **CallCentre**: A call service providing voice information services for an area.
- The **TrunkLocalities** container element holds instances of:
 - **TrunkLocality**: A geographical grouping of stops as relevant for trunk access associated also with an **NptgLocality**.

Distributed Journey Planning information includes

- **AdjacentRegionExchangePoints** are pairings of *NaPTAN* points between regions to guide journey planners that use the *JourneyWeb* protocol. They distinguish the significant points on the boundaries of travel information areas that journey planners using the *JourneyWeb* protocol need to recognise.

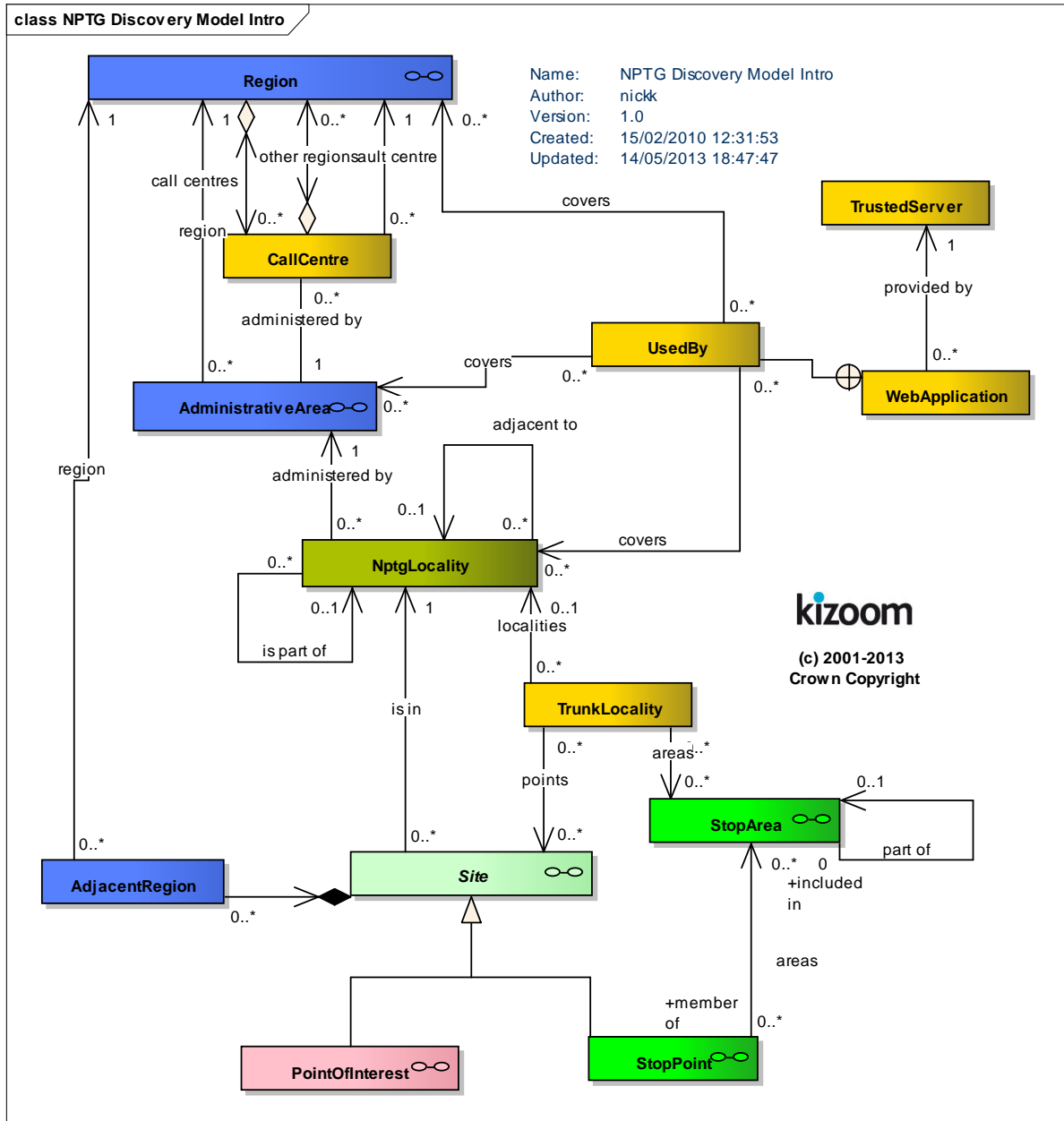

Figure 3-31 – UML Diagram of Discovery Model: Overview

Figure 3-32 shows the same elements as in Figure 3-31, with further detail as to the organisational elements of the schema and the properties of individual entities.

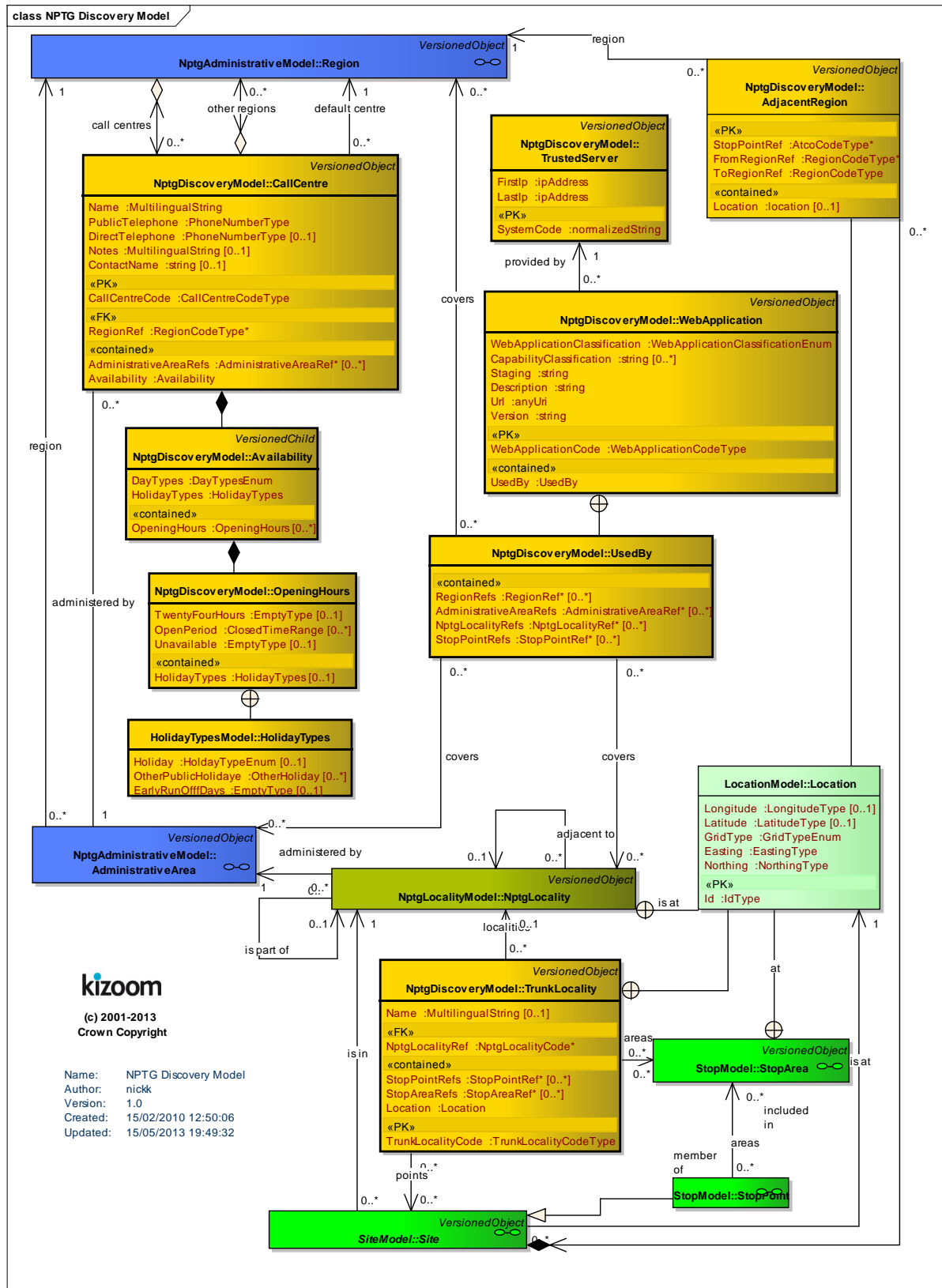

Figure 3-32 – UML Diagram of Discovery Model: Detail

3.6.3 Service Discovery

The coverage model makes it possible to associate Web Services of a particular type with specific NaPTAN stops. See *Figure 3-33*. The association can be done at different levels, for example:

- Individual Localities.
- Administrative Areas.
- Regions.

Since (i) Every stop point knows its *NPTG* Locality; (ii) Every *NPTG* Locality knows its *AdministrativeArea*, and; (iii) Every *Administrative Area* knows its region, it is possible to find the appropriate services that cover a particular stop.

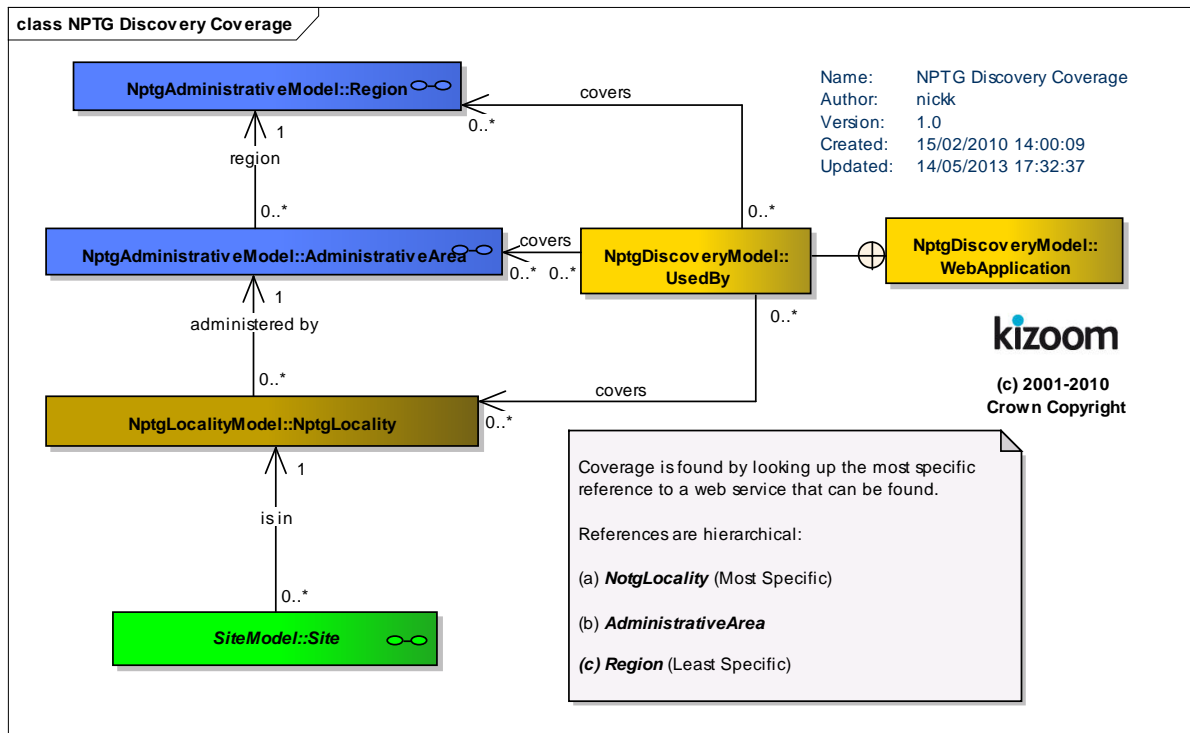

Figure 3-33 – UML Diagram of Coverage Model

3.6.3.1NPTG Discovery Element Hierarchy

Figure 3-34 shows the Class Hierarchy for the Discovery Element Elements. **StopPoint & Stop Area** are versioned elements. **StopAvailability, StopAreaRef & Descriptor** are child elements.

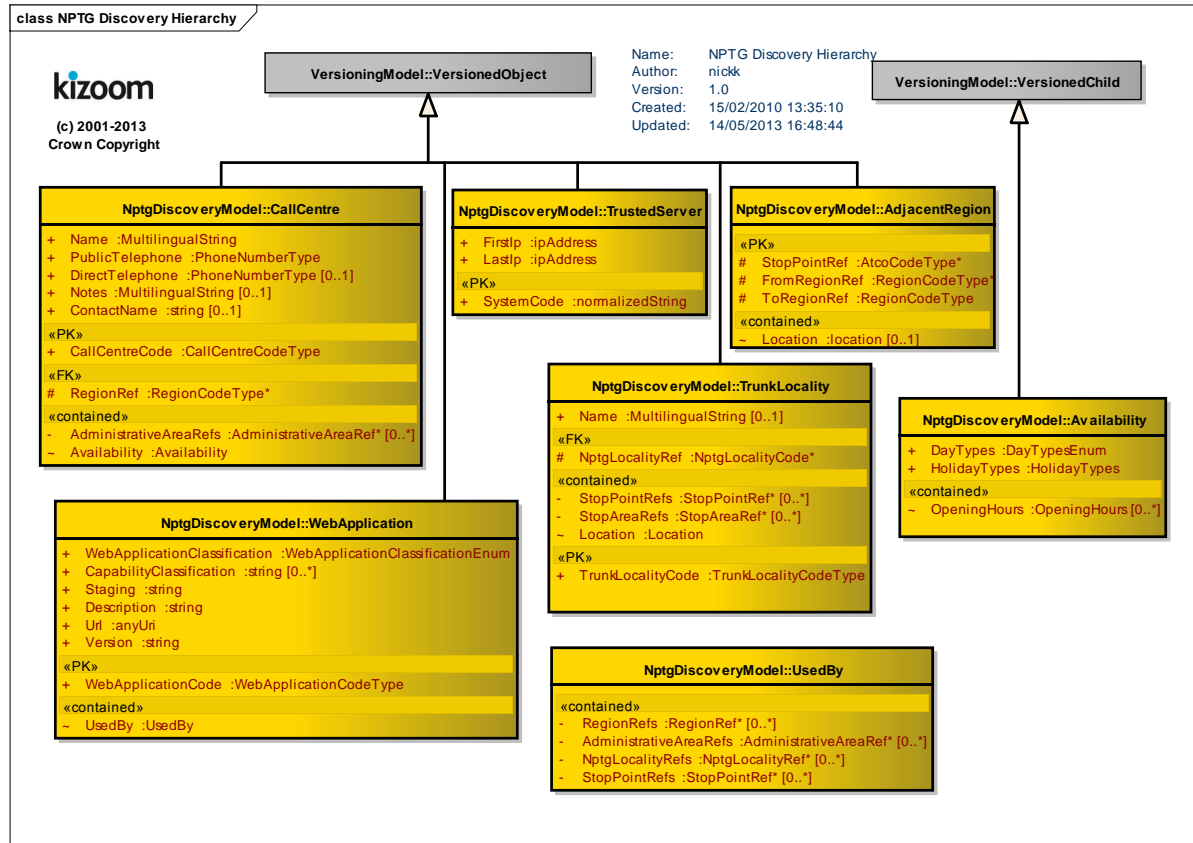

Figure 3-34 – UML Diagram of NPTG Discovery Hierarchy

3.7 Summary of NPTG and NaPTAN Entities and Identifiers

Table 3-17 summarises the main entities of the NPTG and NaPTAN models. It also shows the identifiers used for each element and their scope (which in all cases must be unique within a document). The elements fall into three scope groups:

- *External Codes* forming part of well-defined national data systems ('A'). For example the **AtcoCode**, as defined in the NaPTAN data set. External codes are modelled as elements.
- *External Codes* forming part of arbitrary data systems. ('B'). External codes are modelled as XML elements, and their names generally end in either '**Code**' or '**Number**'.
- *Internal Identifiers* used to identify objects locally within a document ('C'). Internal identifiers are modelled as an **id** attribute on the entity element.

The uniqueness scope of identifiers is formally defined by XML **keyref** constraints. See 'Integrity Rules' in Section 14.

	Entity	Identifier				
		Type	Required	Name	Has Private Code	Scope
NPTG	Region	Element	R	RegionCode	No	A-National
	AdministrativeArea	Element	R	AdministrativeAreaCode	No	A-National
	NptgDistrict	Element	R	NptgDistrictCode	No	B-National
	NptgLocality	Element	R	NptgLocalityCode	Yes	A-National
	PlusbusZone	Element	R	PlusbusZone Code	No	A-National
NPTG Discovery	CallCentre	Element	R	CallCentreCode	No	B-National
	AdjacentRegionPoint	Attribute	R	AtcoCode	No	A-National
	WebApplication	Element	O	SystemCode	No	B-National
	TrustedServer	Element	O	SystemCode	No	B-National
	TrunkLocality	Element	O	TrunkLocalityCode	No	B-National
NaPTAN	StopPoint	Element	R	AtcoCode	Yes	A-National
		Element	O	NaptanCode		A-National
		Element	O	CleardownCode		A-National
	StopArea	Element	R	StopAreaCode	Yes	A-National
	Network	Element	R	NetworkCode	Yes	B-National
	TariffZone	Element	R	TariffZoneCode	Yes	B-National
	PointOfInterest	Element	R	PointOfInterestCode	Yes	A-National
	Location	Attribute	O	id	No	C-Document

Table 3-17 – Main Entities of the NPTG & NaPTAN Models

3.7.1 Private codes

For a few semantically significant elements in NaPTAN, an additional **PrivateCode** element is supported. The **PrivateCode** facilitates the general purpose exchange of data in NaPTAN format, as instances can be annotated with the alternative identifier, so as to allow the unambiguous reconciliation of element identity between different computer systems on a round trip exchange. For example localities might be annotated with their OS TOID. Table 3-17 also indicates the elements that can have a **PrivateCode**.

The **PrivateCode** element is intended for general use of stop definitions for example in TransXChange general documents– it is ignored on NaPTAN submissions.

4 SCHEMAS

The following sections present the *NPTG and NaPTAN* schema elements in detail.

5. *NPTG Schema*
6. *NaPTAN Schema*
7. *NPTG Discovery Schema*
8. Common Schema Elements & Types

5 NPTG SCHEMA, STRUCTURE AND ELEMENTS

The *NPTG* XML schema (Figure 5-1) describes the cities towns and localities of the UK as a model of XML elements, contained within a **NationalPublicTransportGazetteer** root element.

5.1 NationalPublicTransportGazetteer Root Element

5.1.1 NationalPublicTransportGazetteer Element Attributes

The **NationalPublicTransportGazetteer** element uses the *NaPT* standard schema attributes for versioning, and also has standard attributes to indicate the default data reference systems used:

- **Versioning**
 - **CreationDateTime:** Timestamp of document creation date and time.
 - **ModificationDateTime:** Timestamp of document last modification date and time.
 - **FileName:** Name of file containing the document. (If the document is renamed after creation this will not change).
 - **Modification:** Nature of change: *new*, *revision*. For *NPTG* documents this will always be *'revision'*. Individual elements within the document may be *'new'*.
 - **RevisionNumber:** Optional sequence number for versioning overall document content. Each subsequent issue of the *NPTG* data should have a higher number than the previous one.
 - **SchemaVersion:** Schema version identifier used for the document content model.
- **Data Reference**
 - **xml:lang:** Default language of document. ISO language identifier. Default is English (en). Other significant value is (cy Welsh)
 - **LocationSystem:** Data system to use for location coordinate references within the document: *WGS84* or *Grid*. *Grid* is used for collecting the *NPTG* and *NaPTAN* datasets.
 - **GridType:** Default grid system to assume for grid coordinate references within the document if not specified explicitly: *UKOS*, *IrishOs*, *ITM* . Default is *UKOS*. (+NaPT v2.5)

5.1.2 NationalPublicTransportGazetteer Child Elements

The **NationalPublicTransportGazetteer** element (Figure 5-2) contains the following child elements, each of which is described in more detail later in this document:

- **Regions:** A collection of **Region** elements. The **Region** is used to organise other **AdministrativeArea** and **District** elements.
- **NptgLocalities:** A collection of **NptgLocality** elements used to model UK settlements.
- **PlusbusZones:** A collection of **PlusbusZone** elements used to model UK Plusbus fare zones.

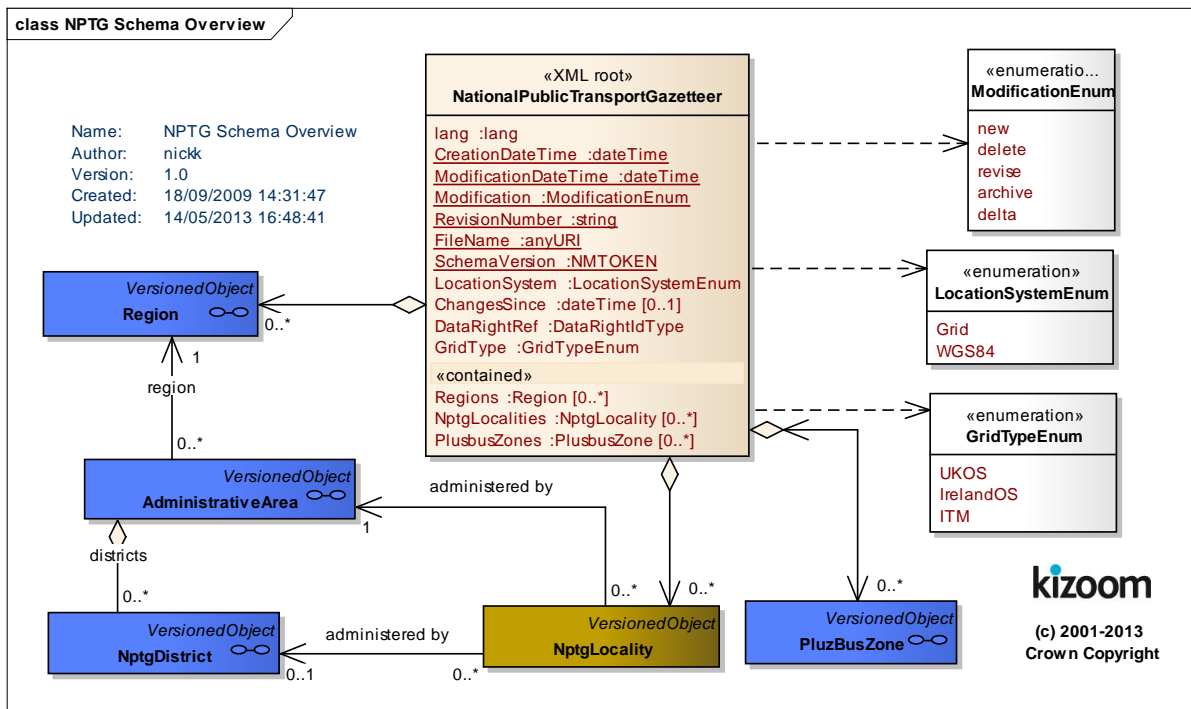

Figure 5-1 – NPTG Schema Overview

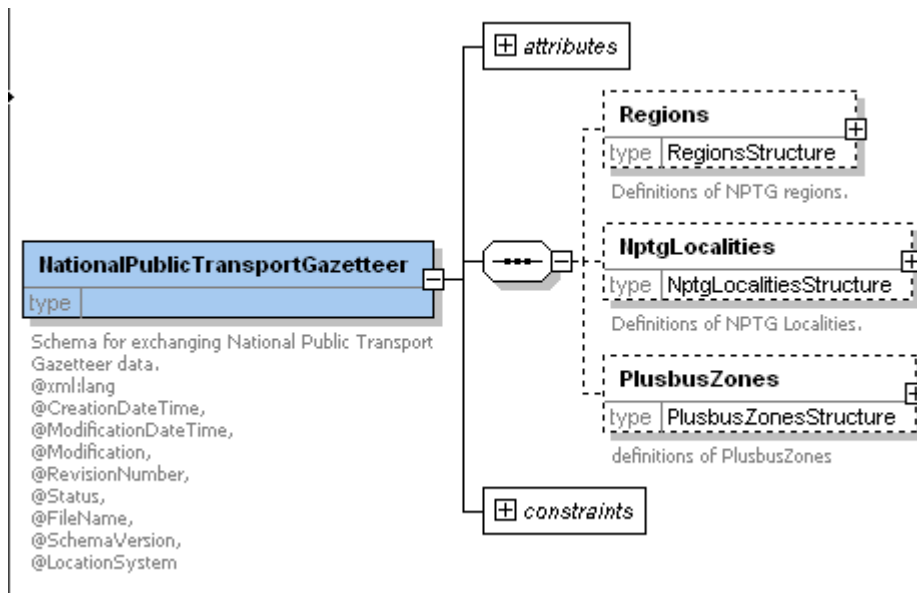

Figure 5-2 – NationalPublicTransportGazetteer Root Element

5.2 Region Element

A **Region** represents an area of the country covered by a single Traveline region. Regions break the UK down into non-overlapping zones, and are themselves broken down into administrative areas. The **Region** element (Figure 5-3) comprises:

- **RegionCode:** Unique NPTG code for **Region**.
- **Name:** Name of **Region**.
- **Country:** Country within which the **Region** lies. See Table 5-1.

Value	Description	Great Britain	UK
England	England	Y	Y
Scotland	Scotland	Y	Y
Wales	Wales	Y	Y
GreatBritain	United Kingdom (can be used for global data)	Y	Y
NorthernIreland	Northern Ireland	N	Y
UK	United Kingdom (can be used for global data)	N	N
Eire	Eire (use for connecting stops)	N	N

Table 5-1 – Allowed Values for Country

- **AdministrativeAreas:** Administrative Areas making up the region. See **AdministrativeArea** below.

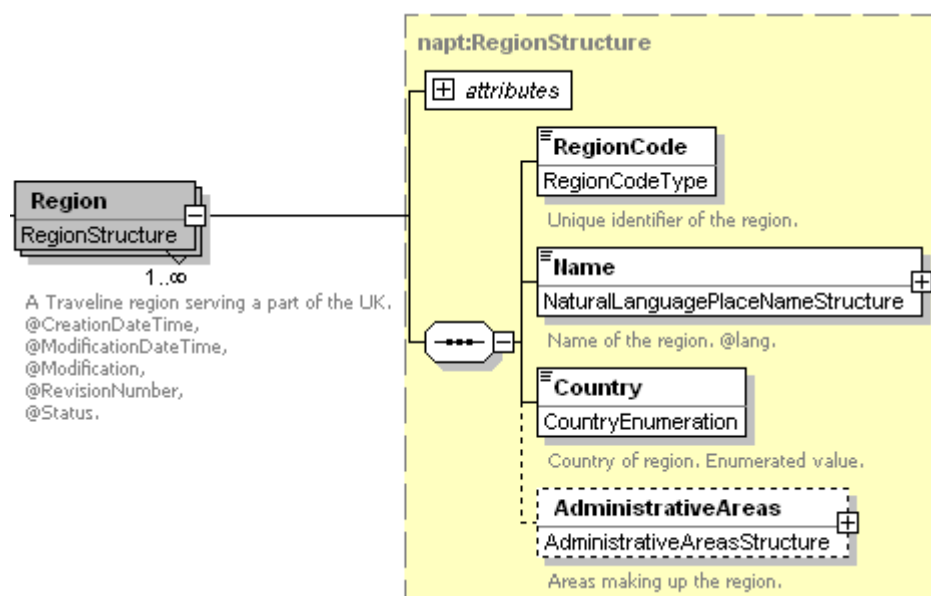

Figure 5-3 – Region Element

5.3 AdministrativeArea Element

An **AdministrativeArea** (Figure 5-4) is an area of the country within a Traveline region that manages the NPTG localities and NaPTAN stops for that area.

- **AdministrativeAreaCode:** Unique NPTG identifier for **AdministrativeArea**. Note this is distinct from the **AtcoAreaCode**.
- **AtcoAreaCode:** Prefix to use on all stops points and stop areas for **AdministrativeArea**.
- **Name:** Text **Name** in a specified language, indicated by an xml:lang attribute. Names are restricted to the NaPTAN naming character set.
- **ShortName:** Concise text name to use when the **AdministrativeArea** name is used as a qualifier. For example 'E Yorks might be the short name for 'East Riding of Yorkshire'.
- **NptgDistricts:** A collection of **NptgDistrict** elements used to model UK organisational districts.

- **MaximumLengthForShortNames:** Some areas have a processing restriction on the name of stops for use in various systems. This value sets the limit for the area (Zero means same length as **CommonName**). **StopPoint/Descriptor / ShortCommonName** instance values must not exceed this length.
- **National:** Whether **AdministrativeArea** administers stops nationally, or only for its own geographical area (the default). For areas that issue stop types nationally (the '9nn' admin areas) this should be set to true.
- **NaptanPrefixes:** Collection of zero, one or several **AlphaPrefix** elements describing the 'SMS' stop prefixes reserved for the area for use in **NaptanCode** instances. Typically these are chosen to have a mnemonic relationship to the area name. For example, 'sur' = 'Surrey', 'lei' = 'Leicester'.
 - ❖ Either three characters of the form 'a-z' or three digits (not beginning with 0 or 1)
 - ❖ or '1' : London
- **CleardownRange:** Inclusive range of Cleardown numbers reserved for the area for use in **StopCleardownCode** instances.
 - ❖ **CleardownStart:** Start number of Range.
 - ❖ **CleardownEnd:** End number of range.
- **ContactEmail:** Administrative contact email for data queries. Should be a general address rather than an individual.
- **ContactTelephone:** Administrative contact telephone for data queries.

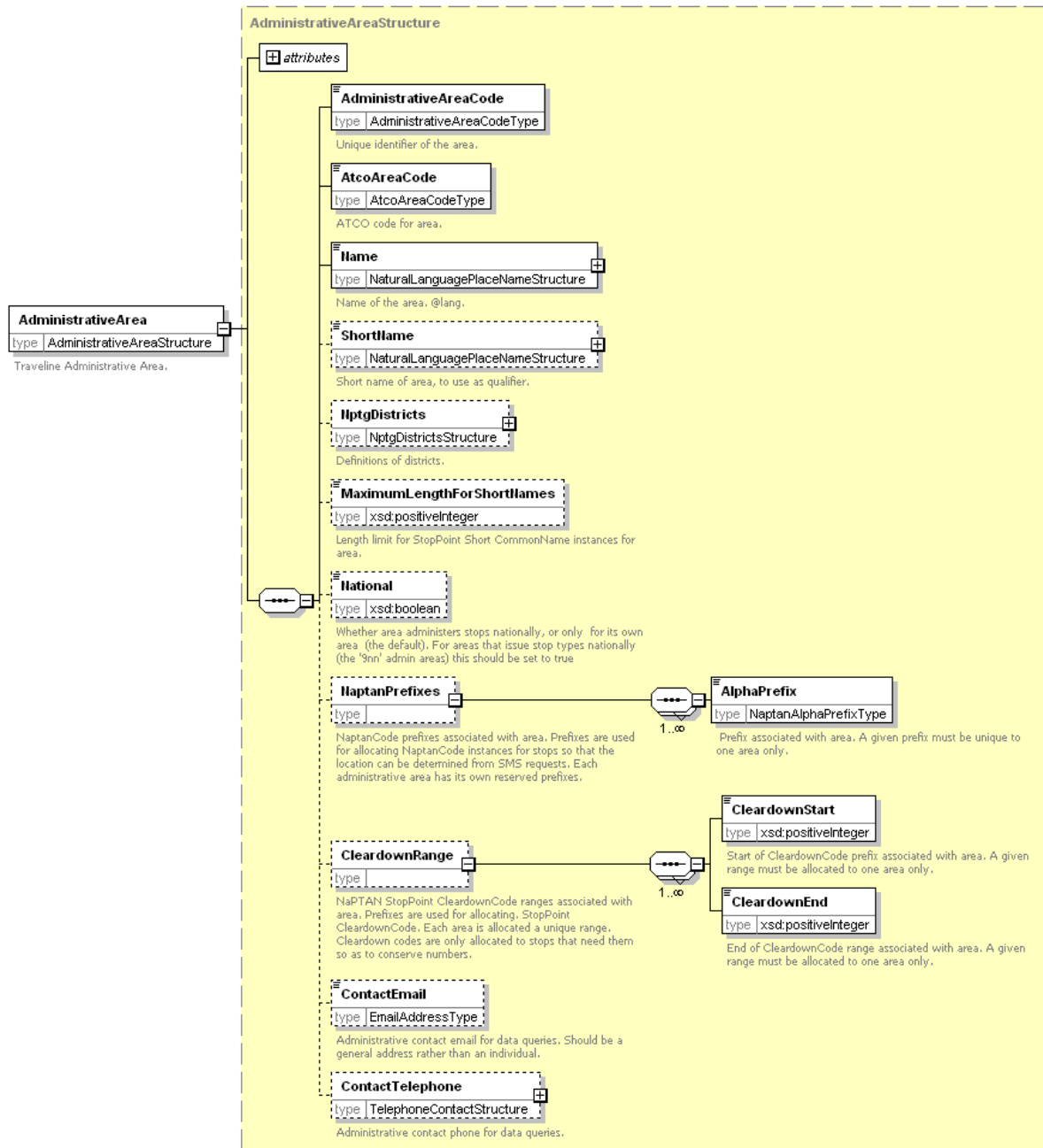

Figure 5-4 – AdministrativeArea Element

5.4 NPTG Locality Element

An **NptgLocality** (Figure 5-5) represents a named UK settlement, that is, a village, town or city. Each locality has both an identifier and a definitive name that is unique and unambiguous.

5.4.1 Identification

- **NptgLocalityCode:** Unique identifier of the **NptgLocality**.
- **Descriptor:** Text description in a specified language, indicated by an **xml:lang** attribute.
- **AlternativeDescriptors:** One or more alternative **Descriptor** elements may be specified. The name may either be an alias, for example, 'Newcastle' for 'Newcastle-on-Tyne', or a translation in a specified language. For example, lang=en, name='Carnarvon', as an alternative name for the common name of lang=cy, name='Caernarfon'.

5.4.2 Associations

- **ParentNptgLocalityRef:** An **NptgLocality** may reference one other **NptgLocality** as its parent. It may itself be referenced by several children. Cyclic dependencies are not allowed, that is a locality must not be its own ancestor, either direct or indirect.
- **AdministrativeAreaRef:** **NPTG AdministrativeArea** responsible for managing stop.
- **NptgDistrictRef:** An **NptgDistrictRef** with which the locality is associated.

5.4.3 Other classifications

- **SourceLocalityType:** The type of locality in the original source material used to compile the **NPTG**. The classification is an annotation that indicates the origin of the locality data; see Table 5-2. The source material for **NPTG** was taken originally from the *Index of Place Names* compiled by ONS (and its Scottish equivalent).

Value	Description	Notes
Add	New entry in the National Gazetteer	
Co	Community	Wales only
Lo	Locality	Other locality
LOC	Scottish Locality	Scotland only
Pa	Parish	not Wales
PAR	Scottish Parish	Scotland only
Isl	Island	
U	Urban Area	
US	Urban Sub Area	
DWD	Scottish District Ward	Scotland only
RED	Scottish Registered Electoral District	Scotland only

Table 5-2 – Allowed Values for SourceLocalityType

- **LocalityClassification:** **NPTG** classification of locality as a type of settlement. See Table 5-3. Classification implies a hierarchy of containment: each classification type has a ranking associated with it. Lower level elements may specify same or higher level elements as their parents on a **ParentNptgLocalityRef**, but not vice versa. Thus a city may contain a suburb, but a suburb may not contain a city.

Value	Name	Ranking
city	Locality is a city.	1
town	Locality is a town.	2
suburb	Locality is an urban sub-area.	2
urbanCentre	Locality is a city centre or town centre zone of another town or city locality.	3
village	Locality is a village.	3
hamlet	Locality is a hamlet.	4
placeOfInterest	Locality is a place of interest whose name is distinct from another locality.	4
other	Locality is none of the other types.	2
unrecorded	Locality type is not yet specified.	3

Table 5-3 – Allowed Values for LocalityClassification

- **Location:** Specifies a spatial point corresponding to the centre of the locality. See **Location** element above.
- **Extensions.** Placeholder to allow user defined extensions.

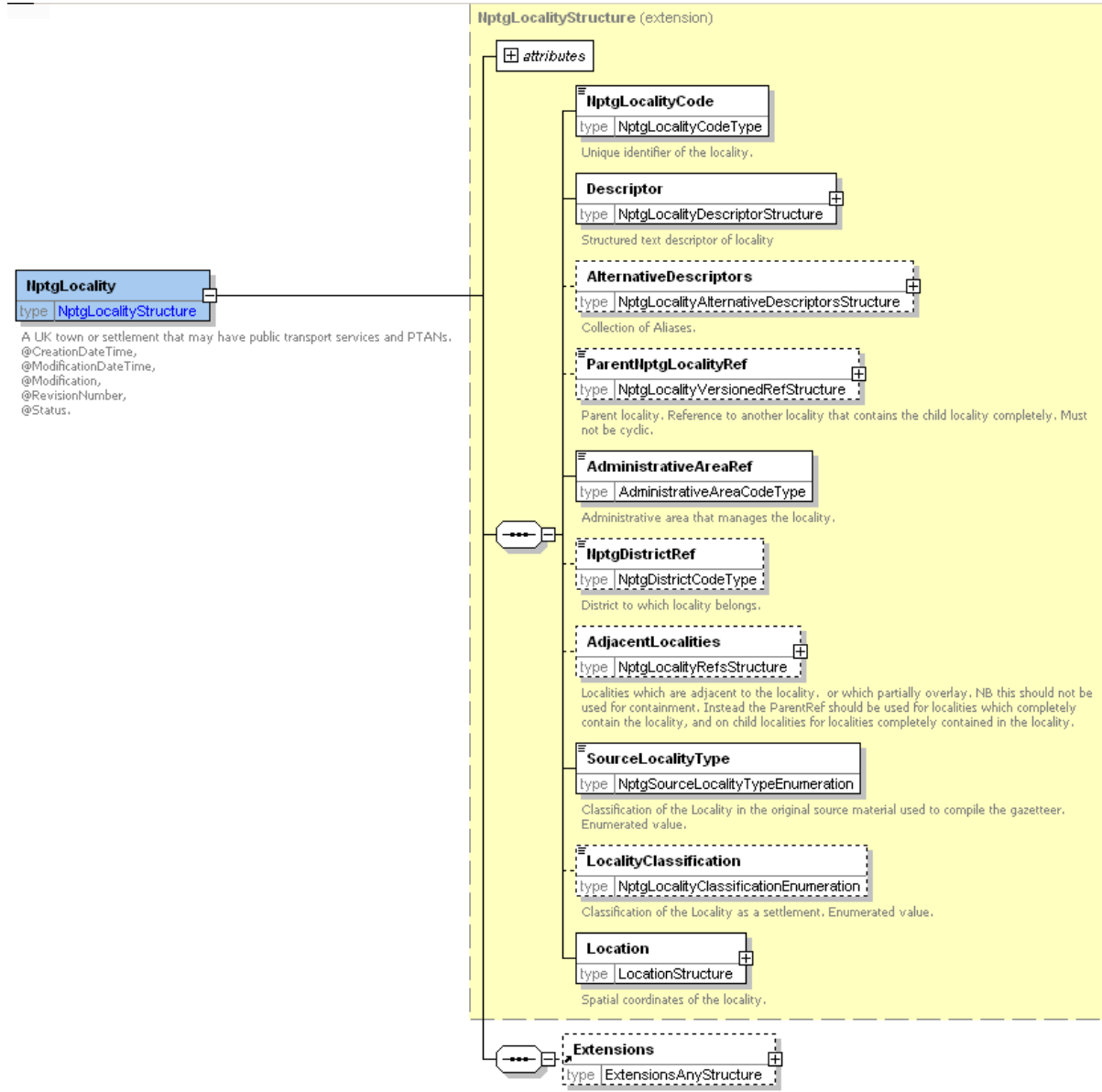

Figure 5-5 – NptgLocality Element

5.5 NPTG Locality / Descriptor Element

A Locality Descriptor (Figure 5-6) provides a textual description of a locality.

- **LocalityName:** Unique NPTG name of the locality. Should be a valid place name subject to the same restrictions on characters as a NaPTAN **CommonName**.
- **ShortName:** Short name for the locality.
- **Qualify:** Whether the name is qualified, and if so by what other
 - **QualifierName:** Whether the name is qualified, and if so by what other name. For example, **LocalityName** 'Church End' + **QualifierName** Flummox would result in → Church End (Flummox)

In addition, you may give information about the qualifying scope: this should be the most specific context within which the name should be distinguished.

- **NptgLocalityRef**: A locality nominated as the source of the **QualifierName**.
- **NptgDistrictRef**: A district nominated as the source of the **QualifierName**.

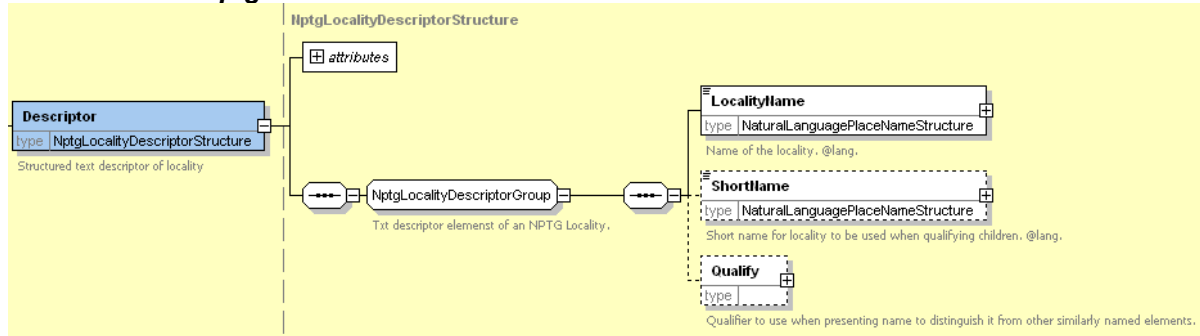

Figure 5-6 – Locality / Descriptor Element

5.6 NPTG District Element

An **NptgDistrict** (Figure 5-7) represents a Metropolitan or Shire District authority, that is, a city, borough or district council.

- **NptgDistrictCode**: Unique NPTG identifier of the district.
- **Name**: Text description in a specified language, indicated by a lang attribute.

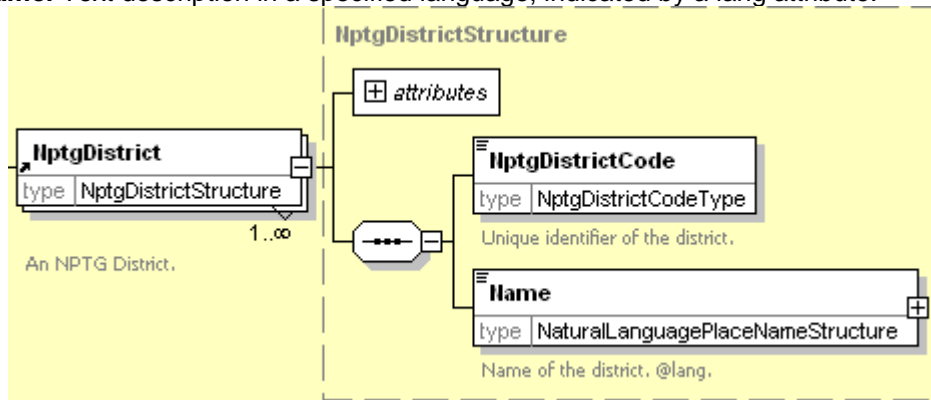

Figure 5-7 – NptgDistrict Element

5.7 PlusbusZone Element

A **PlusbusZone** (Figure 5-8) represents a Plusbus fare zone. Plusbus Zone information will normally be added centrally and redistributed.

- **PlusbusZoneCode**: Unique identifier of the zone (usually the TIPLOC of the principle station in the zone).
- **Name**: Text description in a specified language, indicated by a lang attribute.
- **Country**: The country of the **PlusbusZone**. See Table 5-4.

Value	Name
England	England
Northern Ireland	Northern Ireland
Scotland	Scotland
Wales	Wales
UK	UK

Table 5-4 – Allowed Values for Plusbus zones

- **Mapping**: A sequential collection of **Location** points describing the bounding polygon, in which the last point links to the first point to complete the polygon.

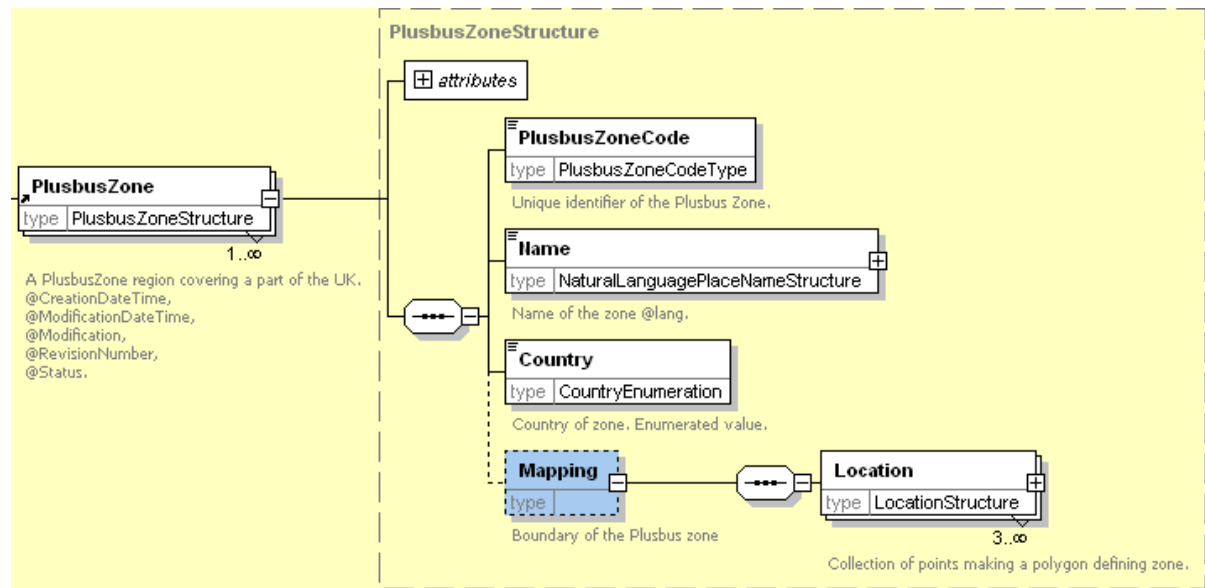

Figure 5-8 – PlusbusZone Element

6 NaPTAN SCHEMA, STRUCTURE AND ELEMENTS

NaPTAN XML schema (Figure 6-1) describes bus stops and other public stop points as a model of XML elements, contained within a **NaPTAN** root element. It references entities defined in the NPTG schema.

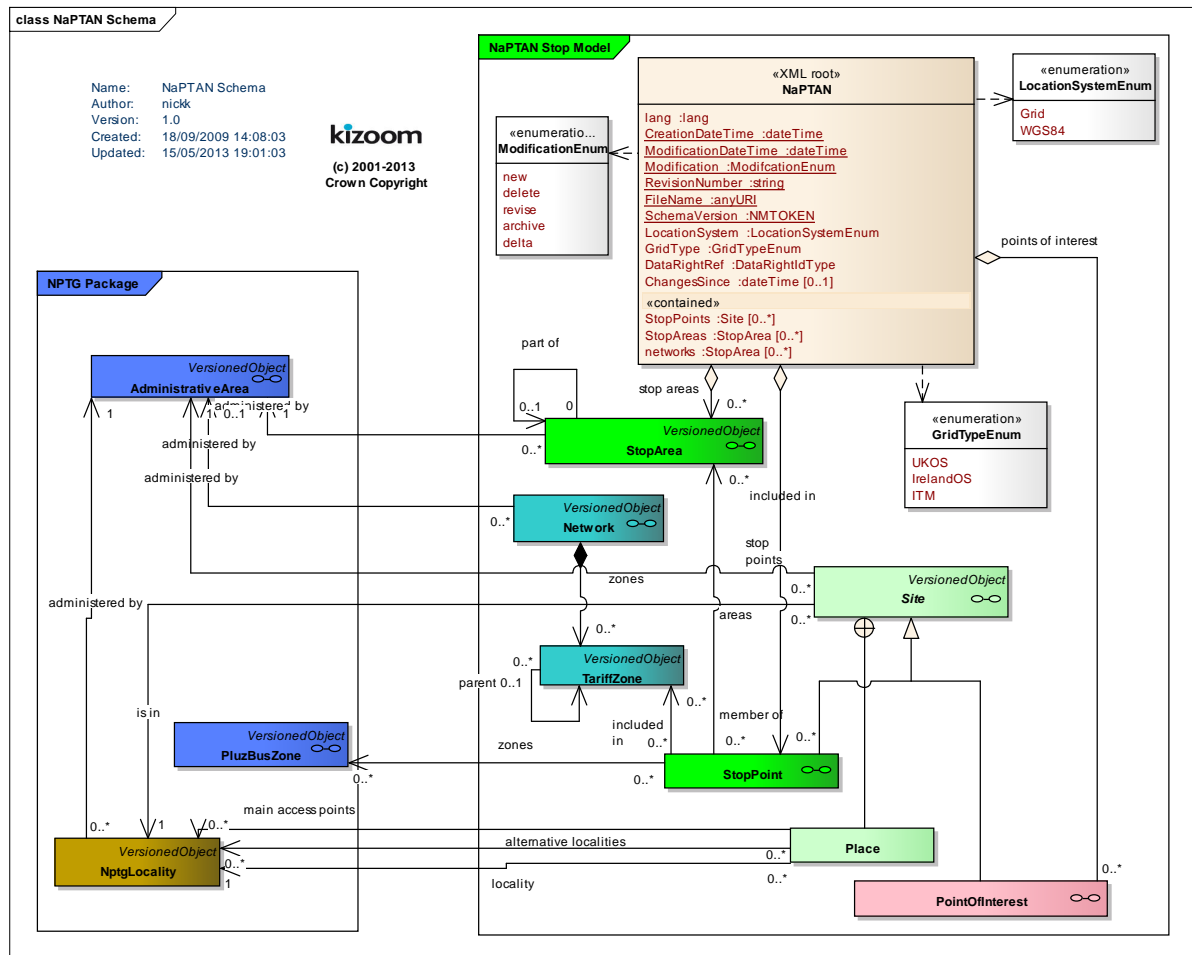

Figure 6-1 – UML Diagram of NaPTAN Schema

6.1 NaPTAN Root Element

6.1.1 NaPTAN Element Attributes

The **NaPTAN** root element uses the *NaPT* standard schema attributes for versioning, and also has standard attributes to indicate the default data reference systems used (Since these are attributes they are not shown in the Diagram): See discussion of versioning later on in section 11.2.

- **Versioning**
 - **CreationDateTime:** Timestamp of document creation date and time.
 - **ModificationDateTime:** Timestamp of document last modification date, and time.
 - **FileName:** Name of file containing the document as created. (If the document is renamed this will not change).
 - **Modification:** Nature of change: *new*, *revision*. Normally *revision*. Other possible values are *delete* or *archive*.

- **RevisionNumber:** Optional sequence number for versioning overall document content.
- **SchemaVersion:** Schema version identifier used for the document content model.
- **ChangesSince:** Only present when a delta of modifications being exchanged . Date after which changes are included. (+NaPT v2.4). **DataSource:** Indication of source of data. (+NaPT v2.4).
- **Data Reference**
 - **lang:** Default language of document. ISO language identifier. Default is English.
 - **LocationSystem:** Data system to use for location coordinate references within the document: *WGS84* or *Grid*. Normally *Grid* is used.
 - **GridType:** Default grid system to assume for grid coordinate references within the document if not specified explicitly: *UKOS*, *IrishOs*, *ITM* . Default is *UKOS*. (+NaPT v2.5)

6.1.2 NaPTAN Child Elements

The **NaPTAN** root element (Figure 6-2) comprises the following child elements:

- **StopPoints:** A collection of **StopPoint** elements defining individual PTANS. See below.
- **StopAreas:** A collection of **StopArea** elements to group stop points. See later.
- **Networks:** A collection of **Network** elements to group TariffZones (+NaPT v2.5). See later below.
- **PointsOfInterest:** A collection of **PointsOfInterest** (+NaPT v2.5). See later below.

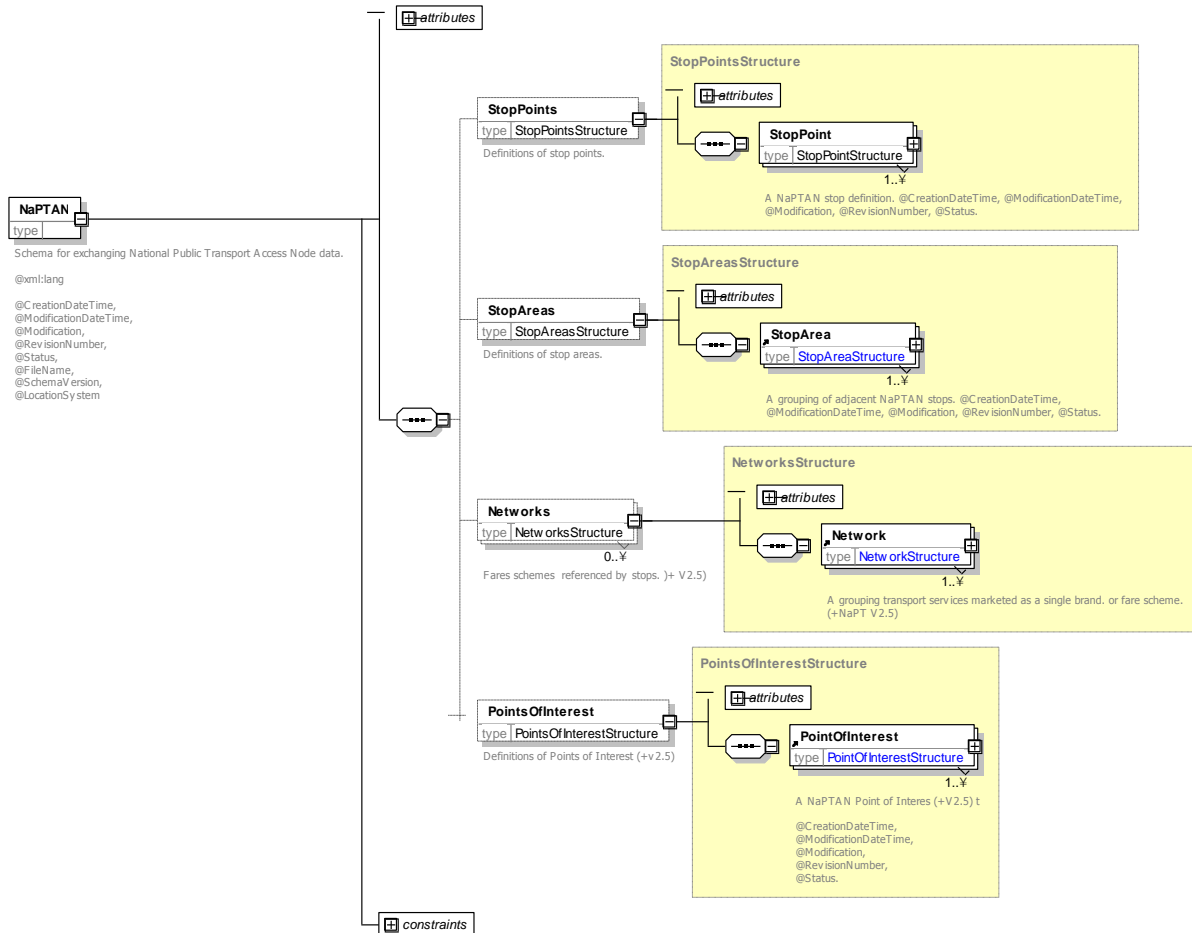

Figure 6-2 – NaPTAN Root Element

6.2 StopPoint Element

A *NaPTAN StopPoint* (*Error! Reference source not found.*) describes an access point to public transport and comprises the following elements.

The identifiers of a *StopPoint* provide a number of alternative ways of uniquely identifying the stop in different contexts. The *AtcoCode* is the primary key: other identifiers are optional aliases. The other fundamental *StopPoint* subelements are the *Descriptor*, *Place* and *StopClassification*.

- **AtcoCode:** Unique NaPTAN system identifier of *StopPoint*. Codes are unique within the NaPTAN database for Great Britain. *AtcoCode* instances normally have the form *a0b*, where 'a' is the three digit *AtcoAreaCode* (Note that some additional values are used, for example '910 Network Rail'), 0 is fixed, and *b* is an arbitrary unique alphanumeric code of up to eight characters.
- **StopIdentifierGroup:** Groups together alternative unique identifiers of a *StopPoint*. See below.
- **SiteDescriptionGroup:** Groups together elements describing the name and whereabouts of a *StopPoint*. See below.
- **StopClassification:** categorizes the *StopPoint*. This is described separately later below.
- **StopReferencesGroup:** Groups together associations of the *StopPoint* With other entities. See below.
- **StopFurtherDetailsGroup:** Groups together further properties of a *StopPoint*. See below.

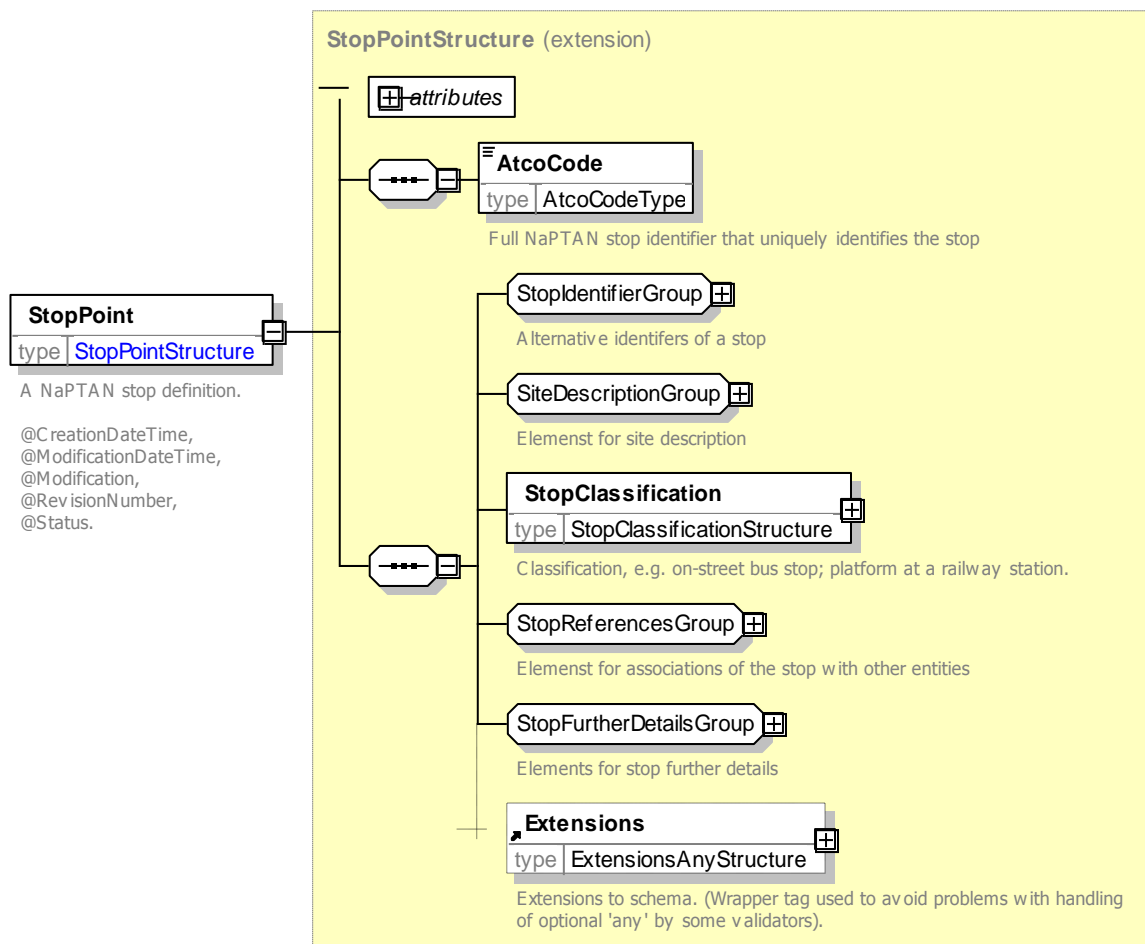

Figure 6-3 – StopPoint Element

6.3 Identifying the Stop – StopIdentifierGroup

The **StopIdentifierGroup** group (*Identifying the Stop*) organises the alternative identifier elements that are also allowed for a **StopPoint** in addition to the **AtcoCode**.

- **NaptanCode:** Unique NaPTAN public identifier of **StopPoint**, i.e. SMS number. **NaptanCode** instances are unique within the NaPTAN database for the UK. Prefixes of the **NaptanCode** correspond to UK administrative areas. The **NaptanCode** is constrained to certain values so as to make it easy to enter on a mobile keypad. See Populating NaPTAN codes for SMS earlier.
The **NaptanCode** is composed of two parts:
 - A one or three character area **AlphaPrefix** prefix, chosen ideally to have mnemonic relevance to the administrative area name of the locality, and using any of the letters (or numbers) mapped to a given key. For example, **sur** for Surrey. London is treated as a special case and has a one character prefix of '1'. All other areas use a three character all alpha or all numeric code which cannot begin with 0 or 1.
 - Three to five character (letters or numbers) stop reference unique within the area grouping, for example **dagm**, '7456'. The choice of letters or numbers is made by each administrative area – the prefix and suffix elements should be either wholly alpha or wholly numeric.
- **PlateCode:** Unique asset code identifier of stop point. This element is to support the general exchange of stop data, and is not currently part of the NaPTAN 1.1 database.
- **CleardownCode:** Unique cleardown identifier of stop point. A number between 1 1048575 that AVL systems may use to reference the stop for direct wireless cleardown of stop based arrival and departure displays. Designed to be short. i.e. 20 bit to suit wireless restrictions. Numbers are allocated by administrative area. Numbers should only be allocated if needed (so as to conserve available numbers). This element is for use support the general exchange of stop data, and is not currently part of the NaPTAN 1.1 database.
- **PrivateCode:** Unique identifier for associating stop with other identifiers used by other systems. This element is to support the general exchange of stop data and is not part of the NaPTAN database. For example when stop definitions are exchanged in *TransXChange* between AVL systems, it may be useful to annotate them with private identifiers in order for the stops to be related to legacy systems.

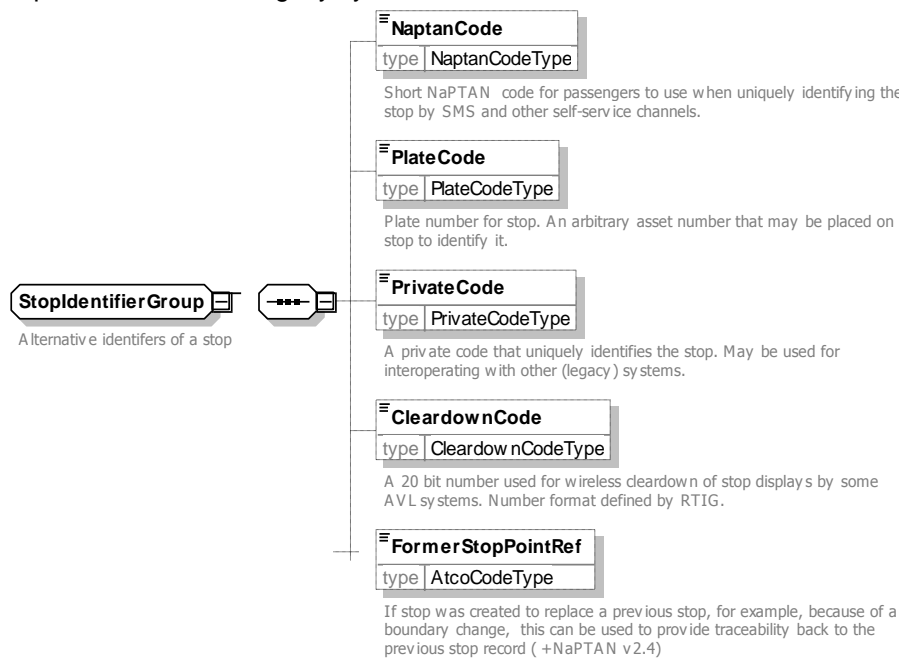

Figure 6-4 – StopIdentifierGroup Group

6.4 Descriptors of a Stop – SiteDescriptionGroup

The descriptors of a **StopPoint** provide structured elements for describing the name of a stop and its location (See Figure 6-5).

- **Descriptor:** Elements concerned with the naming of the stop point. See Below
- **AlternativeDescriptor:** Elements concerned with the alternative naming of the stop point. See Below
- **Place:** Description of location and *NPTG* locality of stop point. See below.

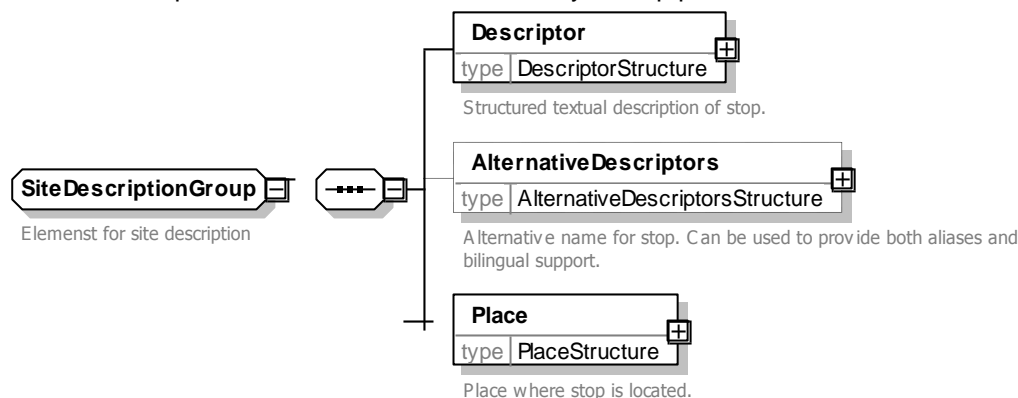

Figure 6-5 – SiteDescriptionGroup Group

6.4.1 Descriptor Element

6.4.1.1 Base Descriptors

The **Descriptor** element (Figure 6-6) groups elements concerned with naming the stop point. See also discussion under *Naming Stops* earlier in this guide.

- **CommonName:** Name of the stop area, with *xml:lang* attribute.
- **ShortCommonName:** A short version of the common name, compacted to fit within the specified length limit for the stop's administrative area, as specified by the **AdministrativeArea / MaximumLengthForShortNames**. A **ShortCommonName** only needs to be specified if it is different from the **CommonName**.
- **Landmark:** Text describing any adjacent landmark that can be used to distinguish stop. The landmark may be a building or destination, or a crossing name or street name (in which case it should also be specified under **Street**, or may be specified under **Crossing**).
- **Street:** Name of street where the stop point of **Place** is. This must still be given even if the stop is named after the street.
- **Crossing:** The nearest street crossing to the stop. Desirable to give if known. If the crossing is also the landmark, or may be omitted
- **Indicator:** Indicative description of the relative position of the stop, See examples for guidance on choice of descriptive phrases for indicator and landmark.

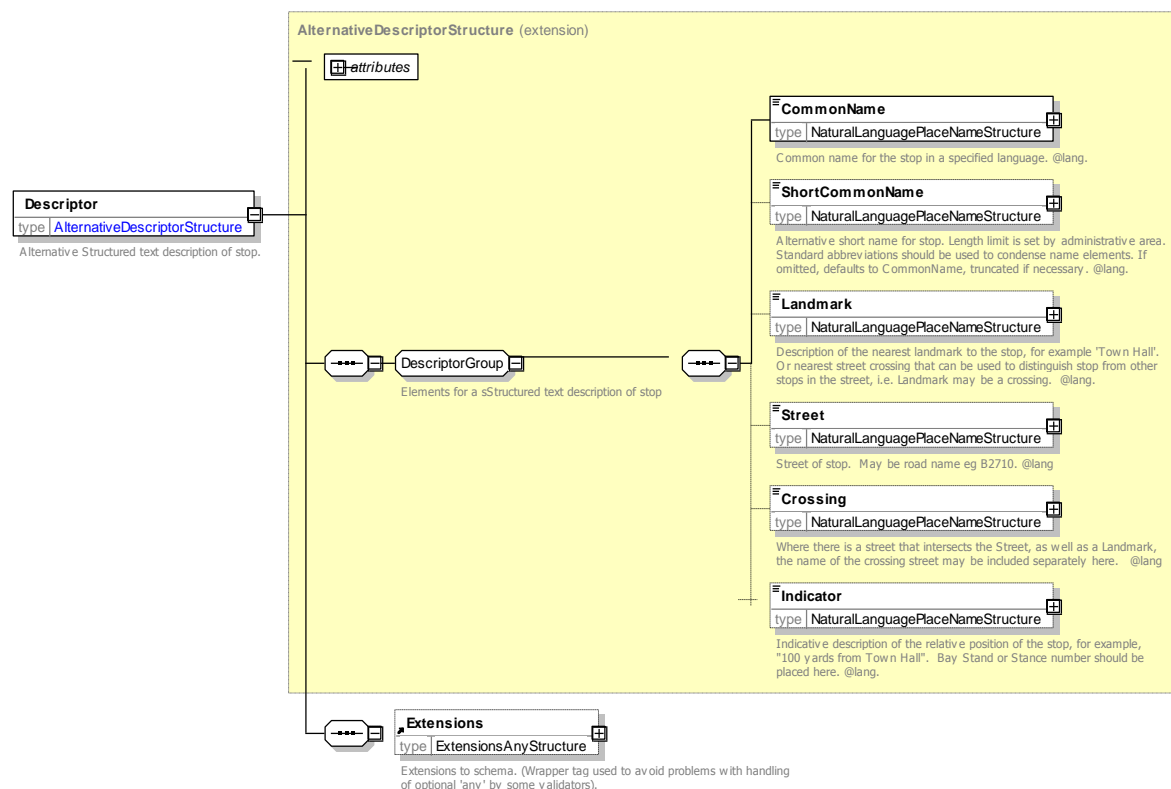

Figure 6-6 – Descriptor Element

6.4.2 Additional Descriptors

- **AlternativeDescriptors:** One or more alternative names can be specified for the stop; each as a subsidiary **Descriptor** element with modification attributes, and a set of base descriptor contents.

6.4.3 Place Element

A **Place** element (Figure 6-7) describes where a **StopPoint** is, and also associates it with an **NptgLocality**.

- **NptgLocality:** Each **Place** must specify the primary **NPTG** locality that the stop point is sited within, using an **NptgLocalityRef** (i.e. the **NptgLocalityCode**). The locality should be the most specific available, for example, use the suburb rather than the city.
- **AlternativeNptgLocalities:** In addition, other localities may be associated with the **Place** as a collection of **NptgLocalityRef** instances. The **StopArea** is considered to be associated with all the **NPTG** localities (and alternative localities) of its member stops.
- **MainNptgLocalities:** In addition, the stop may be designated as a main stop for one or more localities.
- **Suburb:** Name of suburb where the **Place** is.
- **Town:** Name of town where stop point is.
- **Country:** Name of country where stop point is. (+NaPT v2.5). See Table 5-1 for allowed values.
- **LocalityCentre:** Whether the stop point of the **Place** is at the centre of a town or not. A value of 'true' indicates that the stop is one of the central stops in the **NptgLocality**, and that a journey enquiry to the locality could sensibly start or end at this stop. More than one stop point can be designated as a locality centre for a given **NptgLocality**.
- **Location:** Spatial coordinates of the **Place**.

- Note that for Hail & Ride stops, the location will be the OS Grid Easting and Northing of the central anchor point of a Hail-and-Ride section.

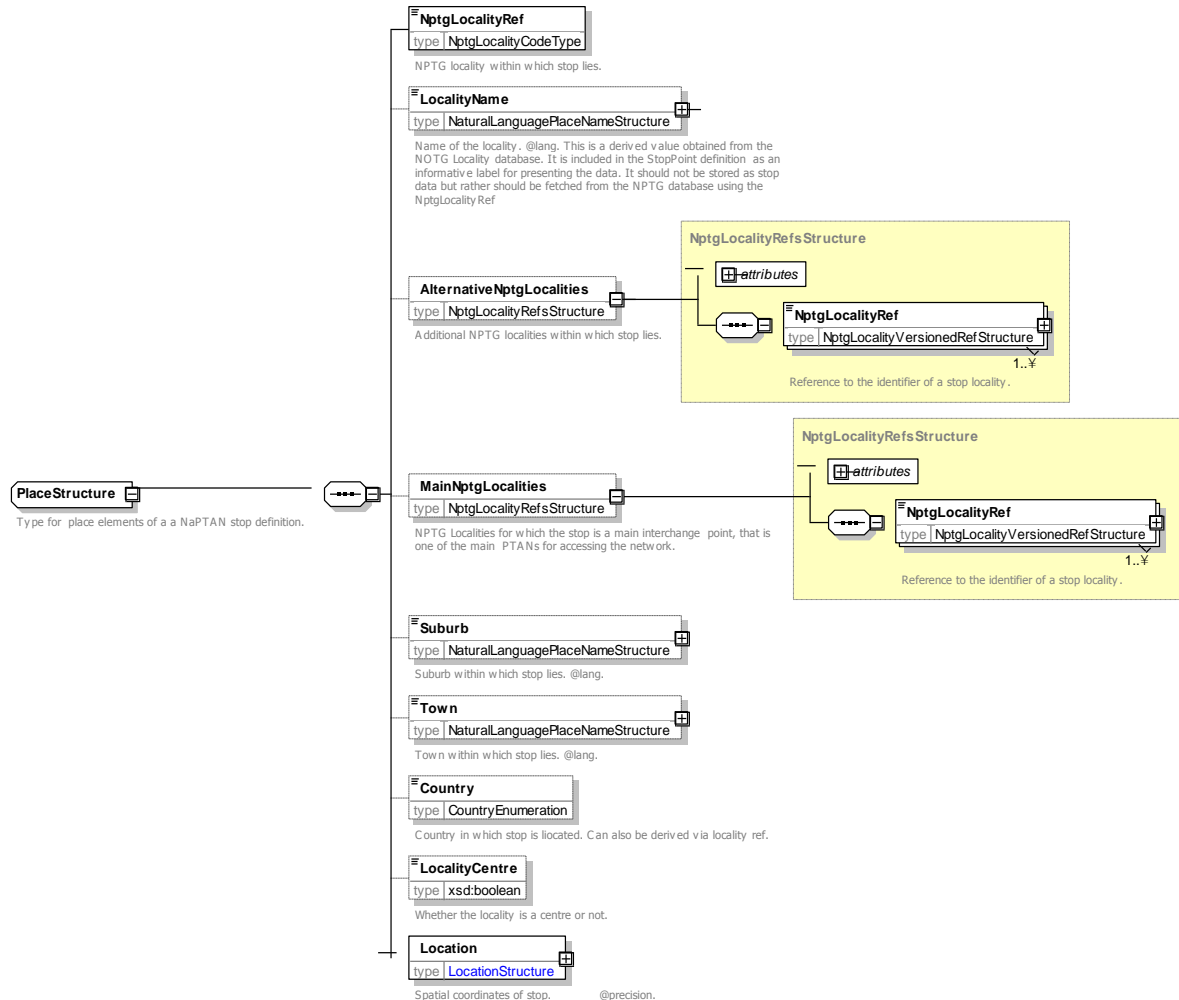

Figure 6-7 – Place Element

6.5 Associations of a Stop – StopReferencesGroup

The associations of a **StopPoint** allow it to be linked to other types of NPTG and NaPTAN entities (See Figure 6-8). The associated entity (e.g. **StopArea**, **AdministrativeArea**, **PlusbusZone**, **TariffZone**) should be active and valid at the time the association is created. If the associated entity is subsequently made inactive, the association (if not explicitly removed as well) is also considered to be inactive and may be ignored.

- StopAreas**: A collection of **StopAreaRef** instances identifying any **StopArea** elements with which the **StopPoint** is associated. The **StopArea** may be in a different administrative area to that of the **StopPoint** itself.
 - Note that this association can also be used to derive the locality of the **StopArea**. The **StopArea** is considered to be associated with all the NPTG localities (and alternative localities) of its member **StopPoint instances**. Different stop points in a given stop area may belong to different NPTG localities. Normally the stop points of a **StopArea** will belong to the same or descendent NPTG localities, but it is possible that the stops may be in different NPTG localities that are either adjacent or descendent to each other.

- **AdministrativeAreaRef:** NPTG **AdministrativeArea** responsible for managing data about the stop.
- **PlusbusZones:** A collection of **PlusbusZoneRef** instances identifying any **PlusbusZone** elements with which the **StopPoint** is associated.
- **TariffZones:** A collection of **TariffZoneRef** instances identifying any **TariffZone** elements with which the **StopPoint** is associated., i.e. fare zones to which it belongs (+NaPT v2.5).

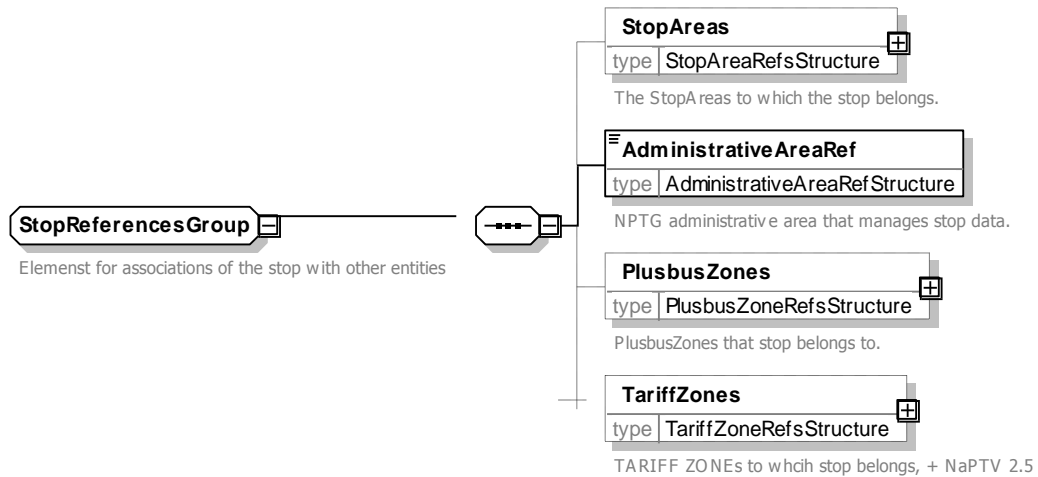

Figure 6-8 – StopReferencesGroup Group

6.6 Other Information – StopFurtherDetailsGroup

Other properties of a **StopPoint** describe it further (See Figure 6-9).

- **Notes:** Any notes about the PTAN. Notes should be used in particular to describe why a stop has been designated as deleted.
- **Public:** Whether stop is for use by general public. Default is true (+NaPT v2.4).
- The **StopAvailability** element defines when the stop is available for use. See below.
- The **StopAccessibility** element specifies the accessibility assessment of the stop i for use. In journey planners. See below.

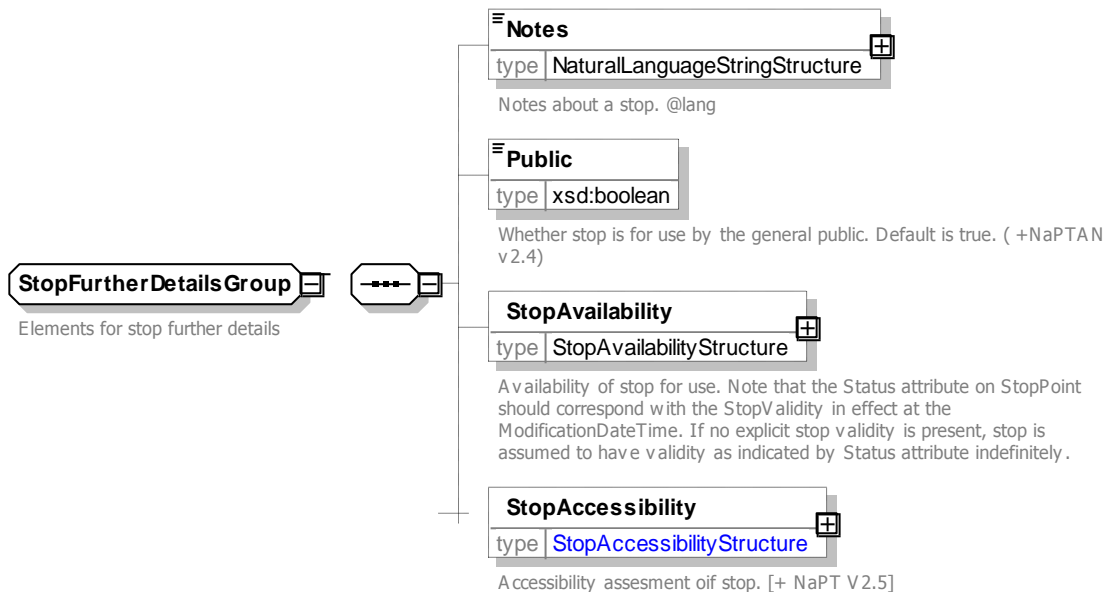

Figure 6-9 – StopFurtherDetailsGroup Group

6.7 StopClassification Element

A **StopClassification** element (*Figure 6-10*) describes the type of stop point, and any additional details associated with the specific stop type

- **StopType:** Type of stop: one of a limited number of values that summarises the stop type. See *Table 6-1*. Each **StopType** corresponds to a particular combination of **StopClassification** subelements (and as such is informationally redundant, but is retained for compatibility with *NaPTAN 1.1*). For example, *BCT* is the same as **OnStreet / Bus** stop classification. Most stop types are issued by individual Administrative areas. Some types, shown with the relevant numeric prefix of the National Area in the Nat column, are issued centrally by administrative areas that have a **National** scope.

Value	Long Value	Description	Nat		Mode	Type
<i>BCT</i>	<i>busCoachTrolleyStopOnStreet</i> (<i>busCoachTramStopOnStreet</i> is supported as a deprecated value)	On-street Bus / Coach / Trolley Stop.	--	On street	BusCoach	MarkedPoint
			--			UnmarkedPoint
			--			HailAndRide
			--			FlexibleZone
<i>TXR</i>	<i>taxiRank</i>	Taxi Rank (head of).	--		Taxi	TaxiRank
<i>STR</i>	<i>sharedTaxiRank</i>	Shared Taxi Rank (head of).	--			Shared TaxiRank
<i>SDA</i>	<i>carSetDownPickUpArea</i>	Set down area	--		Car	Platform
<i>AIR</i>	<i>airportEntrance</i>	Airport Entrance.	--	Off street	Air	Entrance
<i>GAT</i>	<i>airAccessArea</i>	Airport Interchange Area.	920			AccessArea
<i>FTD</i>	<i>ferryTerminalDockEntrance</i>	Ferry Terminal / Dock Entrance.	--		Ferry / Ship	Entrance
<i>FER</i>	<i>ferryOrPortAccess</i>	Ferry or Port Interchange Area	930			AccessArea
<i>FBT</i>	<i>ferryOrPortBerth</i>	Ferry or Port Berth	930			Berth
<i>RSE</i>	<i>railStationEntrance</i>	Rail Station Entrance.	--		Rail	Entrance
<i>RLY</i>	<i>railAccess</i>	Railway Interchange Area.	910			AccessArea
<i>RPL</i>	<i>railPlatform</i>	Railway Platform .	910			Platform
<i>TMU</i>	<i>tramMetroUndergroundEntrance</i>	Tram / Metro / Underground Entrance.	--		Tram / Metro	Entrance
<i>MET</i>	<i>tramMetroUndergroundAccess</i>	Underground or Metro Interchange Area	940			AccessArea
<i>PLT</i>	<i>tramMetroUndergroundPlatform</i>	Underground or Metro platform	940			Platform
<i>LCE</i>	<i>liftOrCableCarStationEntrance</i>	Lift / Cable Car Entrance.	--		Telecabine	Entrance
<i>LCB</i>	<i>liftOrCableCarAccessArea</i>	Lift / Cable Car Area	--			AccessArea
<i>LPL</i>	<i>carSetDownPickUpArea</i>	Lift / Cable Car platform	--			Platform
<i>BCE</i>	<i>busCoachStationEntrance</i>	Bus / Coach Station Entrance.	--		BusCoach	Entrance
<i>BST</i>	<i>busCoachAccess</i>	Bus Coach Station Access Area.	900			AccessArea
<i>BCS</i>	<i>busCoachTrolleyStationBay</i> (<i>busCoachTramStationBay</i> is supported as a deprecated value)	Bus / Coach bay / stand / stance within Bus / Coach Stations.	--			
			--			VariableBay
<i>BCQ</i>	<i>busCoachTrolleyStation-VariableBay</i> (<i>busCoachTramStationVariable-Bay</i> is supported as a deprecated value)	Bus Coach Station Variable Bay.	--			

Table 6-1 – Allowed Values for StopType

- **OnStreet:** Grouping of on-street stop types. Divided into two groups. See below.
 - **Bus:** On-street bus & coach and trolley stops.
 - **Taxi:** Taxi ranks.
 - **Car:** Set Down and Pick up point (+NaPT v2.4)
- **OffStreet:** Grouping of off-street stop types.
 - **Air:** Airport terminal PTANs.

- **BusAndCoach:** Bus & Coach Station PTANs.
- **Ferry:** Ferry or Dock PTANs.
- **Metro:** Metro, Underground or Tram Station Stops.
- **Rail:** Rail Station PTANs.
- **Telecabine:** Lift and Cable car PTANs (+NaPT v2.4)

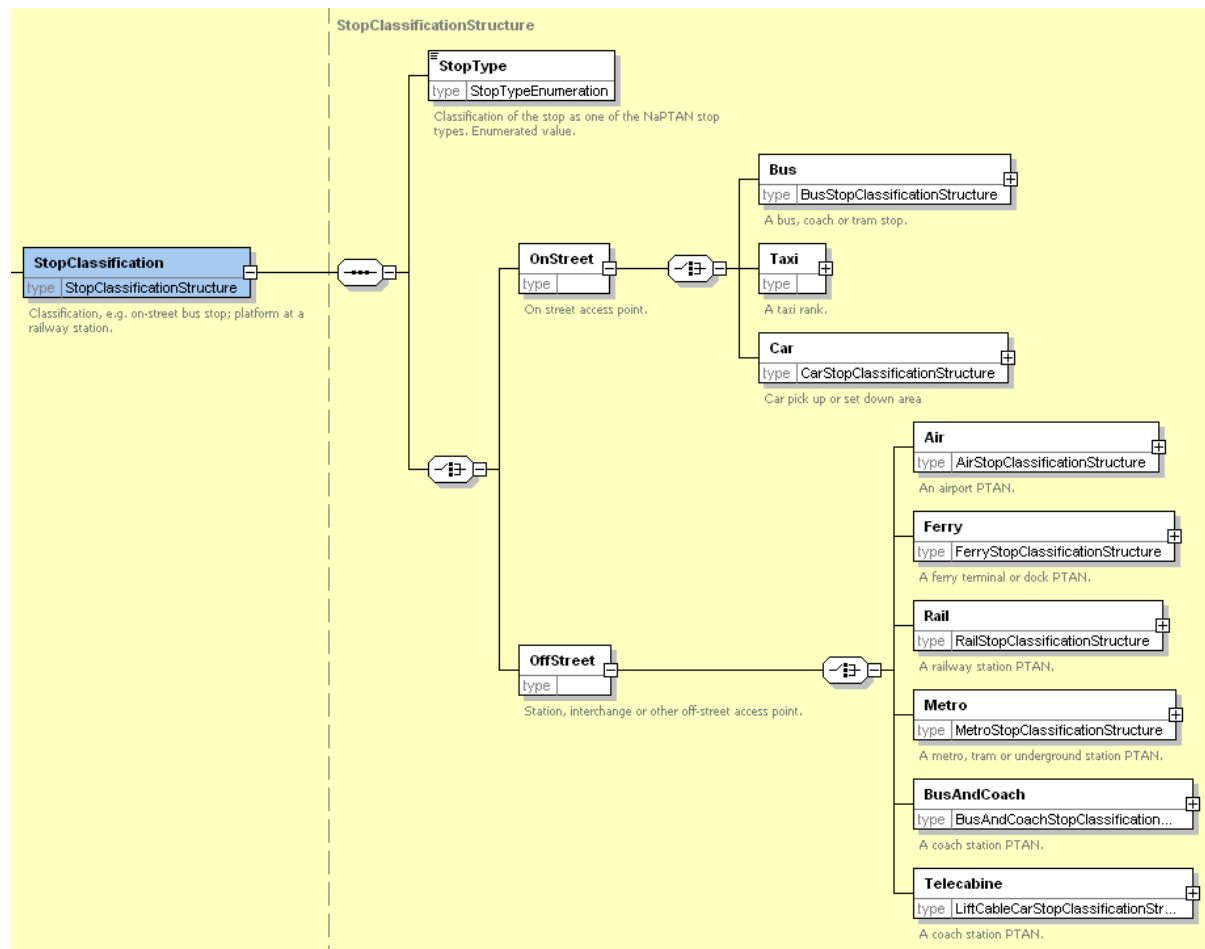

Figure 6-10 – StopClassification Element

StopClassification / On-Street Elements

6.7.1 StopPoint / StopClassification / On-Street Bus Element

The **Bus** element (Figure 6-11) describes information about a stop point that is specific only to on-street bus coach or trolley stops (i.e. 'BCT' stops), and comprises:

- **BusStopType:** Classification of stop. See Table 6-2. Values must correspond to the **BusStopClassificationGroup** choice.

Value		Description		Bus PTAN subtype
MKD	marked	Marked (pole, shelter etc)	Point	MarkedPoint
CUS	custom	Custom (unmarked, or only marked on road)	Point	UnmarkedPoint
HAR	hailAndRide	Hail & Ride – requires Hail & Ride sub-record	Line	HailAndRideSection
FLX	flexible	Flexible zone – Flexible Zone sub-record	Polygon	FlexibleZone

Table 6-2 – Allowed Values for BusStopType

- **TimingStatus:** Expected status of the bus stop in bus service registrations. See Table 6-3. Normally each journey pattern or vehicle journey of a *TransXChange* bus schedule will

specify the specific timing status for the stop usage by an actual service that visits the stop. This is a default value that can be used to assist with the population of multiple services.

Value	Description
PTP	Principal and time info point.
TIP	Time Info Point.
PPT	Principal Point.
OTH	Other Bus Stop.

Table 6-3 – Allowed Values for TimingStatus

- **BusStopClassificationGroup**: The stop must be one of the following subtypes:
 - **MarkedPoint**: Stop is a marked point.
 - **UnmarkedPoint**: Stop is unmarked.
 - **HailAndRideSection**: Stop is a Hail & Ride stop. See below.
 - **FlexibleZone**: Stop is a flexible service zone.

AnnotatedCoachRef: Associates NaPTAN stop point with one or more a coach references. See 6.8.5: below

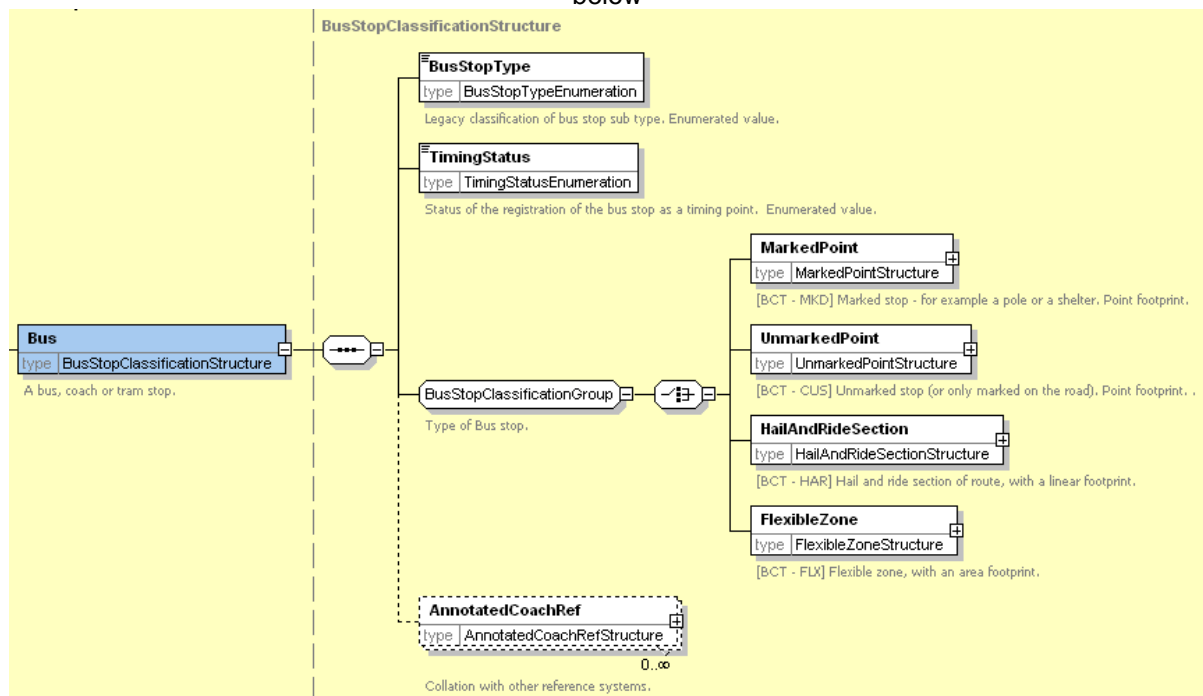

Figure 6-11 – OnStreet / Bus Element

6.7.1.1 On-Street Bus MarkedPoint Element

The **MarkedPoint** element (Figure 6-12) describes the properties of a marked on-street bus, coach or trolley stop. (Stop type 'BCT-MKD').

- **DefaultWaitTime**: Default time to wait at the bus stop – See **Duration** common type. Normally each journey pattern or vehicle journey of a *TransXChange* bus schedule will specify the specific wait time for an actual service that visits the stop. This is a default value that can be used to assist with the population of multiple services.
- **Bearing**: Direction in which a vehicle is pointing when stopped at the stopping point on the road. See **Bearing** element type in *Common Schema Elements*.

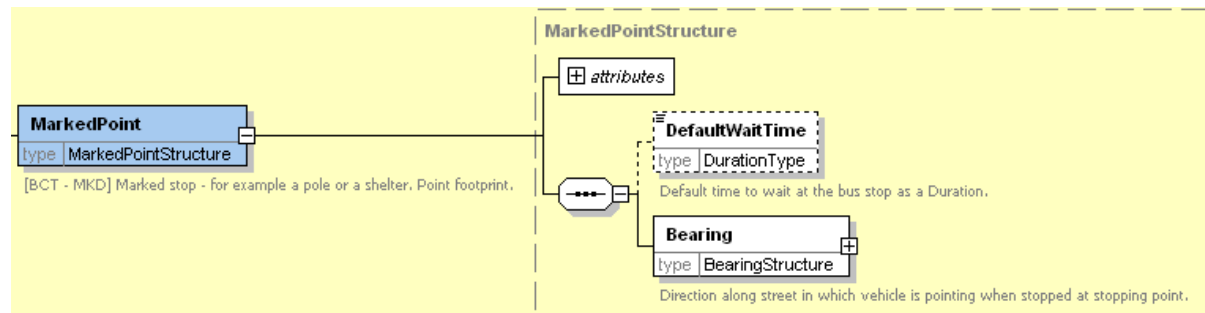

Figure 6-12 – OnStreet / Bus / MarkedPoint Element

6.7.1.2 On-Street Bus MarkedPoint Element

The **UnmarkedPoint** element (Figure 6-13) describes the properties of an unmarked on-street bus, coach or trolley stop. (Stop type 'BCT-CUS').

- **Bearing:** Direction in which a vehicle is pointing when stopped at the stopping point on the road. See **Bearing** element type in *Common Schema Elements*.

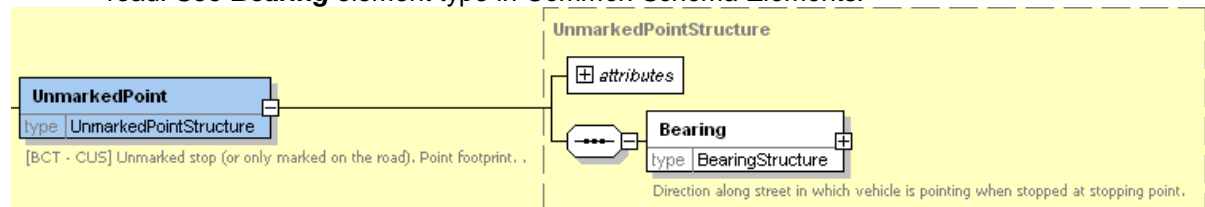

Figure 6-13 – OnStreet / Bus / UnmarkedPoint Element

6.7.1.3 On-Street Bus HailAndRideSection Element

The **HailAndRide** element (Figure 6-14) describes the properties of a Hail-and-Ride stop section. (Stop type 'BCT-HAR').

- **StartPoint:** Location on-street at which section starts.
- **EndPoint:** Location on-street at which section ends.
- **Bearing:** Direction in which a vehicle is pointing when stopped at the anchor point of the section. See **Bearing** element type in *Common Schema Elements*.

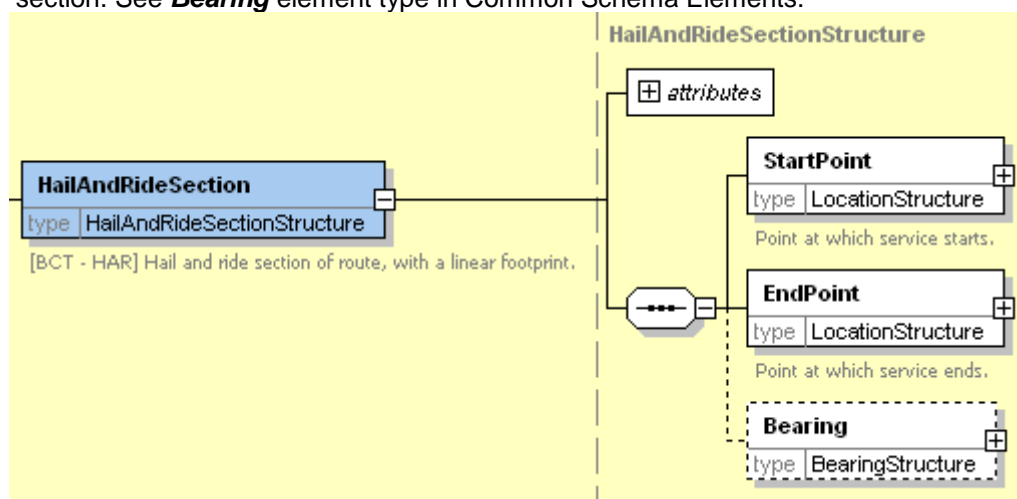

Figure 6-14 – OnStreet / Bus / HailAndRideSection Element

6.7.1.4 On-Street Bus FlexibleZone Element

The **FlexibleZone** element (Figure 6-15) describes the properties of a flexible service stop zone. (Stop type 'BCT-FLX').

- **Location:** One or more location elements listed sequentially, describing the polygon bounding the flexible zone.

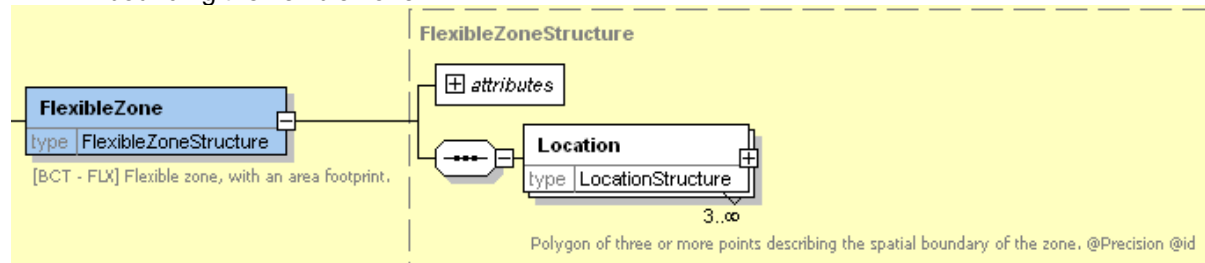

Figure 6-15 – OnStreet / Bus / FlexibleZone Element

6.7.2 On-Street Taxi Element

The **Taxi** element (Figure 6-16) describes the taxi service ‘stops’, i.e. ranks.

- **TaxiRank:** Stop is the head point of a Taxi Rank for normal taxis. (Stop type ‘TXR’).
- **SharedTaxiRank:** Stop is the head point of a Taxi Rank where shared taxis can be found. (Stop type ‘STR’).

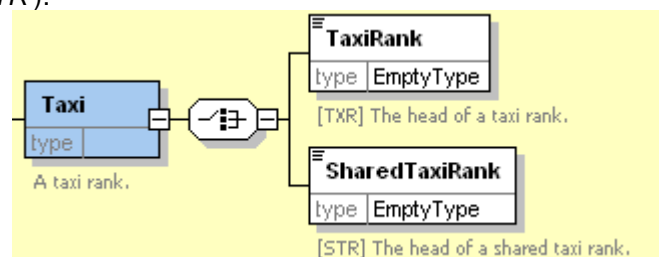

Figure 6-16 – OnStreet / Taxi Element

6.7.3 On-Street Car Element (+NaPT v2.4)

The **Car** element (Figure 6-17) describes the designated points for car passengers to access an interchange. (+NaPT v2.4).

- **PickUpandSetDownArea:** Stop is the pick-up point for cars (Stop type ‘SDA’).

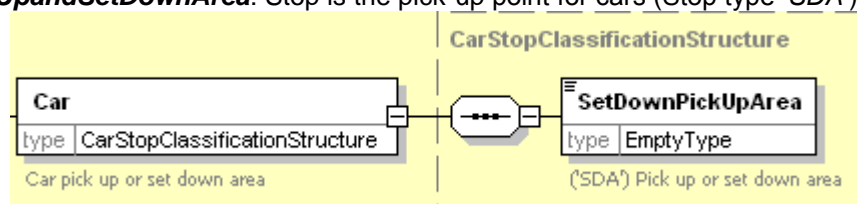

Figure 6-17 – OnStreet / Taxi Element

6.8 StopClassification / Off-Street Elements

6.8.1 Off-Street Air Element

The **Air** element (Figure 6-18) categorises an airport stop. The stop points may be one of two types.

- **Entrance:** PTAN is an entrance – typically the check-in or departure area to the terminal. (Stop type ‘AIR’).
- **AccessArea:** PTAN is an airside interchange area. (Stop type ‘GAT’).

The stop may also be associated with other elements:

- **AnnotatedAirRef:** Translates NaPTAN stop point into an airport reference.
 - **IataRef:** IATA code for the airport.
 - **Name:** Short name of the airport location.

- **Location:** Optional Location of the airport if different from the NaPTAN value.

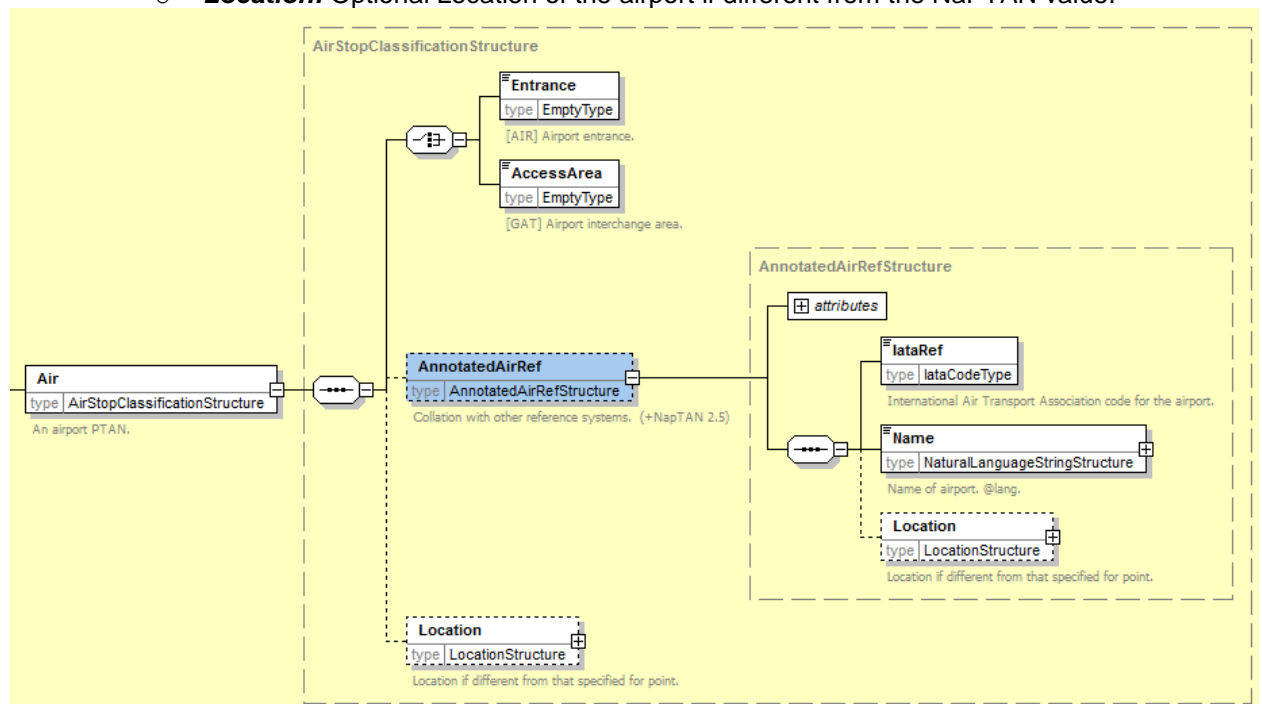

Figure 6-18 – OffStreet / Air Element

6.8.2 Off-Street Ferry Element

The **Ferry** element (Figure 6-19) categorises a ferry port or dock stop point. The stop points may be one of three types.

- **Entrance:** PTAN is an entrance – typically the entrance to the harbour area. (Stop type 'FTD').
- **AccessArea:** PTAN is an interchange area within the harbour – typically the main area of ship berths. (Stop type 'FER').
- **Berth:** PTAN is a berth within the harbour from which a boat is boarded. (Stop type 'FBT').

The stop may also be associated with other elements:

- **AnnotatedFerryRef:** Translates *NaPTAN* stop point into a ferry port reference:
 - **FerryRef:** Reference to the National Ferry/Port code of the ferry harbour or port.
 - **Name:** Short name of the ferry harbour or port.
 - **Location:** Optional Location of the ferry harbour or port.

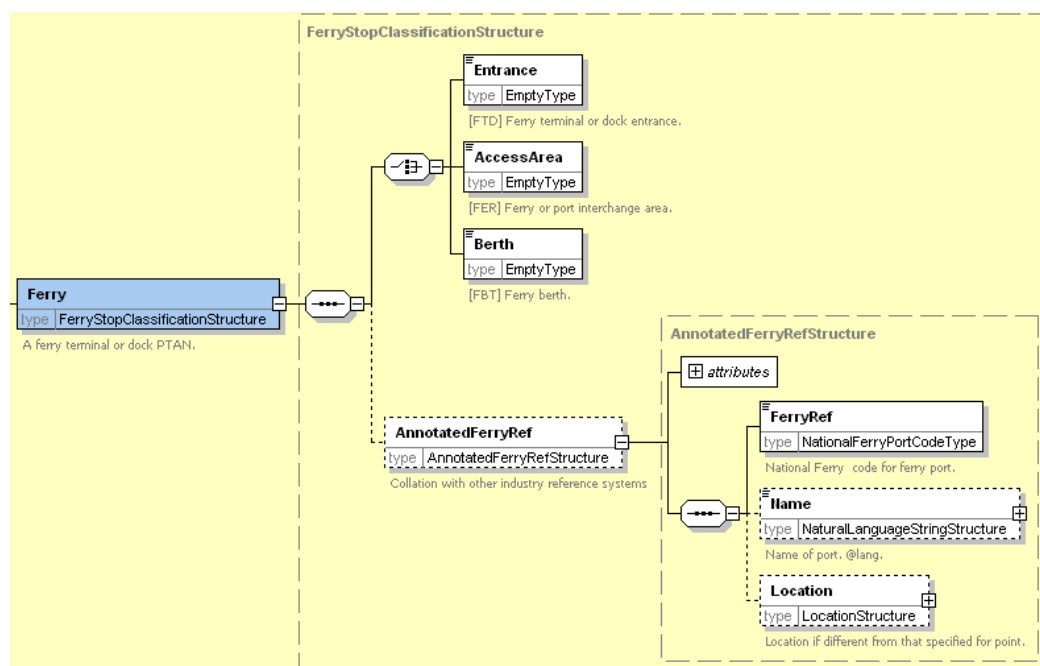

Figure 6-19 – OffStreet / Ferry Element

6.8.3 Off-Street Rail Element

The **Rail** element (*Figure 6-20*) categorises a railway stop. The stop points may be one of three types.

- **Entrance:** PTAN is an entrance – typically the entrance to the station. (Stop type 'RSE').
- **AccessArea:** PTAN is an interchange area within the station – typically the main area of platforms. (Stop type 'RLY').
- **Platform:** A specific platform within the station. (Stop type 'RPL').

The stop may also be associated with other elements:

- **AnnotatedRailRef:** Translates a *NaPTAN* stop point into the location coding system used by rail systems. May be more than one per *NaPTAN* point.
 - **TiplocRef:** Reference to the National Timing Point Location (TIPLOC) code of the station or rail-related location (locations other than stations may also have TIPLOCS). Alphanumeric code.
 - **CrsRef:** Reference to the National Computer Reservation System (CRS) code of the station. CRS codes are short three or four letter mnemonic codes for each station.
 - **StationName:** Text name of the station.
 - **Location:** Optional Location of the station.

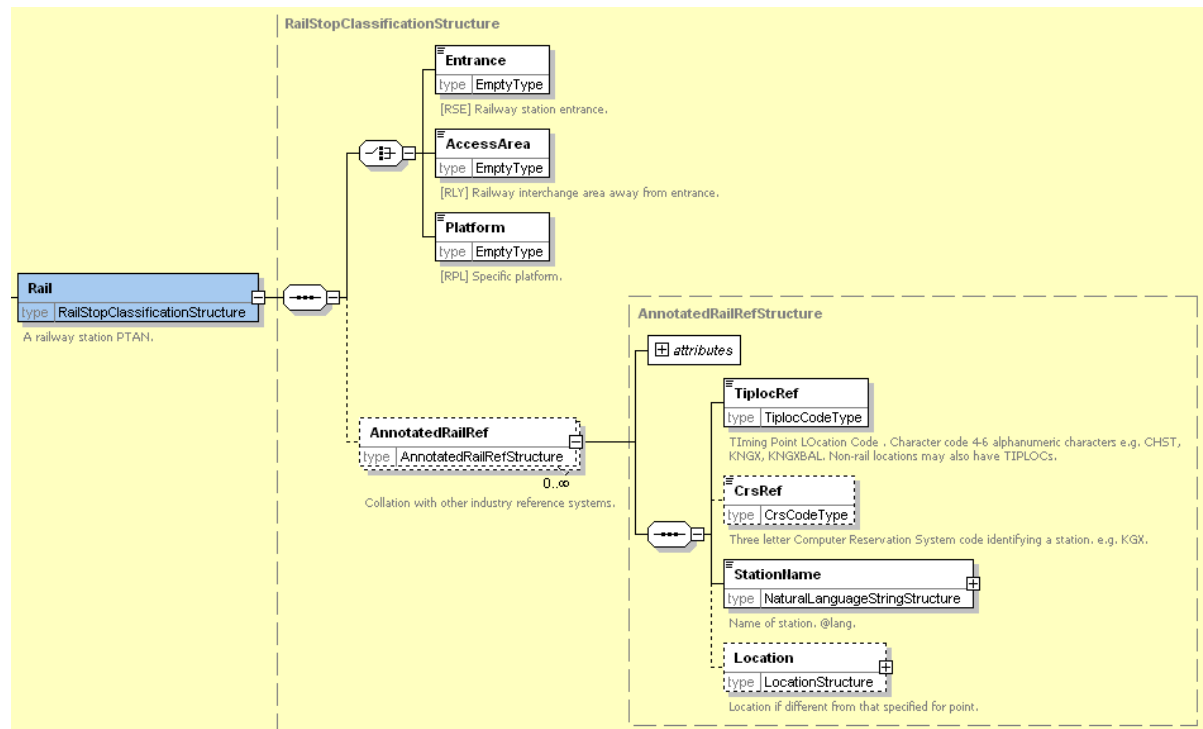

Figure 6-20 – RailExchange Element

6.8.4 Off-Street Metro Element

The **Metro** element (*Figure 6-21*) categorises a metro, light rail, or underground stop. The stop points may be one of three types.

- **Entrance:** PTAN is an entrance – typically the entrance to the station. (Stop type ‘*TMU*’).
- **AccessArea:** PTAN is an interchange area within the building – typically the main area of platforms. (Stop type ‘*MET*’).
- **Platform:** A specific platform within the station. (Stop type ‘*PLT*’).

The stop may also be associated with other elements:

- **AnnotatedMetroRef:** Translates *NaPTAN* stop point into a metro station reference:
 - **MetroRef:** Reference to the National Metro/ code of the station location.
 - **Name:** Short name of the metro station.
 - **Location:** Optional Location of the metro station.

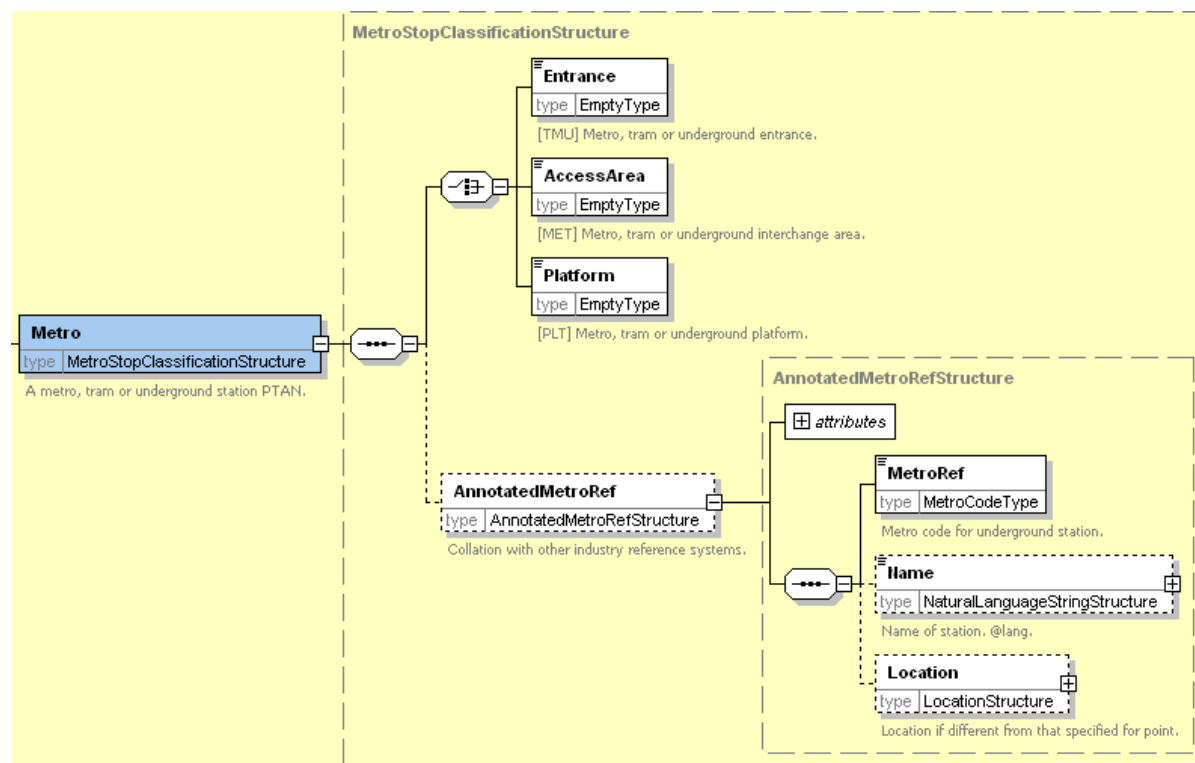

Figure 6-21 – OffStreet / Metro Element

6.8.5 Off-Street BusAndCoach Element

A **BusAndCoach** element (Figure 6-22) categorises a bus or coach stop. The stop points may be one of four types.

- **Entrance:** PTAN is an entrance – typically the entrance to the station. (Stop type 'BCE').
- **AccessArea:** PTAN is an unspecified bay in the general interchange area. The default **TimingStatus** of the stop may be specified. See Table 6-3. Services may use variable stop allocations to allocate. (Stop type 'BST').
- **Bay:** PTAN is a specific bay (Stop type 'BCS').
 - The default **TimingStatus** of the stop may be specified. See Table 6-3.
- **VariableBay:** PTAN is a variable bay. (Stop type 'BCQ'). A variable bay indicates that the bus may be assigned to a different bay at run time.
 - The default **TimingStatus** of the stop may be specified. See Table 6-3.

The stop may also be associated with other elements:

- **AnnotatedCoachRef:** Translates *NaPTAN* stop point into a coach station reference:
 - **OperatorRef:** Reference to the operator code of the coach operator.
 - **CoachRef:** Unique identifier for the coach Stop Point used by a coach company. (Normally from the Nationally unique range including for example stop codes used by the National Express Group).
 - **Name:** Short name of the coach location.
 - **LongName:** Long name of the coach location.
 - **Location:** Optional Location of the coach location.

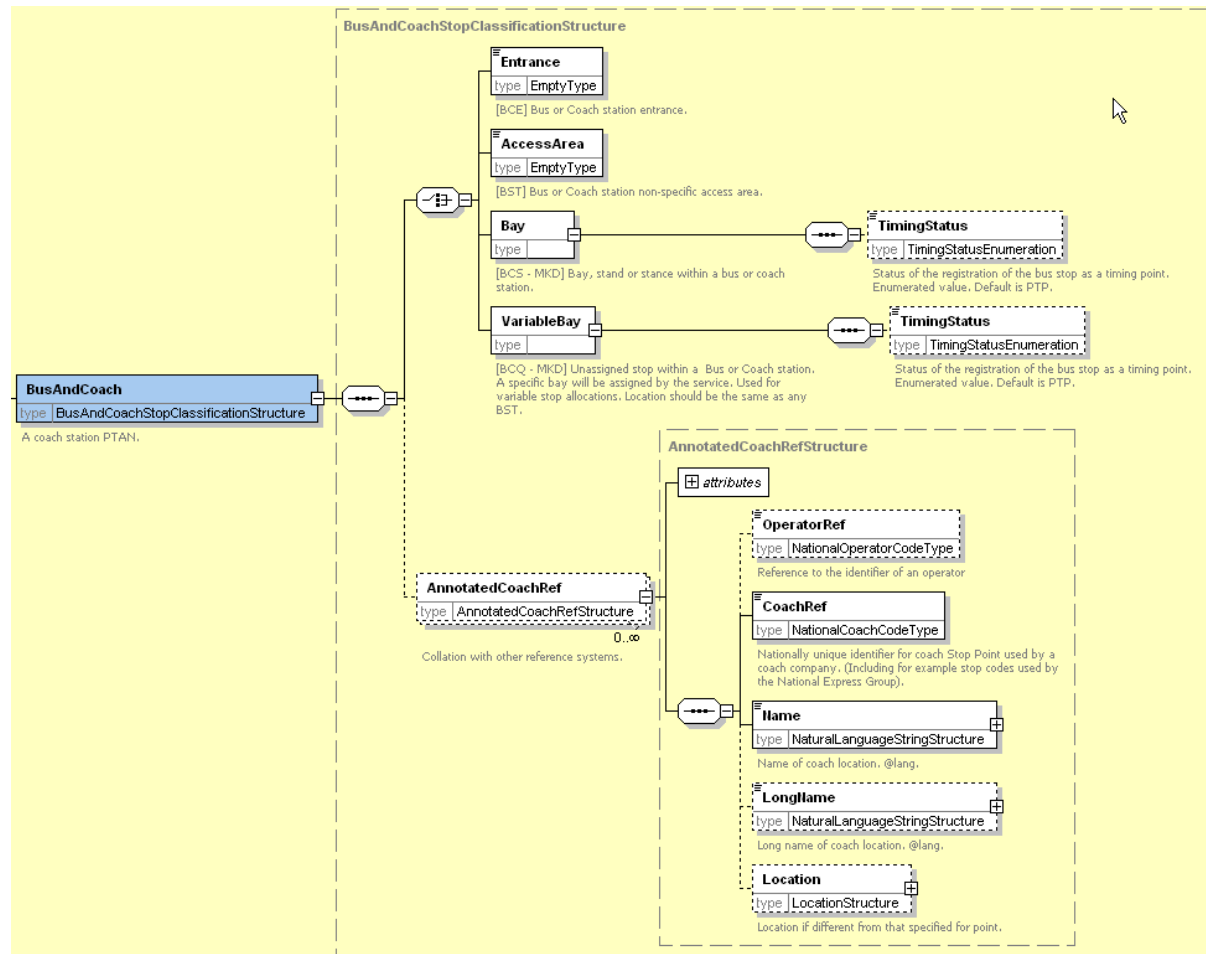

Figure 6-22 – OffStreet / Coach Element

6.8.6 Off-Street Telecabine (Lift & Cable Car) Element (+NaPT v2.4)

The **Telecabine** element (Figure 6-21) categorises a lift or cable car stop. The stop points may be one of three types. (+NaPT v2.4).

- **Entrance:** PTAN is an entrance – typically the entrance to the lift station. (Stop type 'LCE').
- **AccessArea:** PTAN is an interchange area within the lift station – typically the main area of platforms. (Stop type 'LCB').
- **Platform:** A specific platform within the lift station. (Stop type 'LPL').

The stop may also be associated with other elements:

- **AnnotatedCablewayRef:** Translates NaPTAN stop point into a lift station reference: (+NaPT v2.5).
 - **CablewayRef :** Unique identifier for the lift Stop Point used by a cableway operator.
 - **Name** Short name of the lift station location.
- **Location:** Optional Location of the lift station location

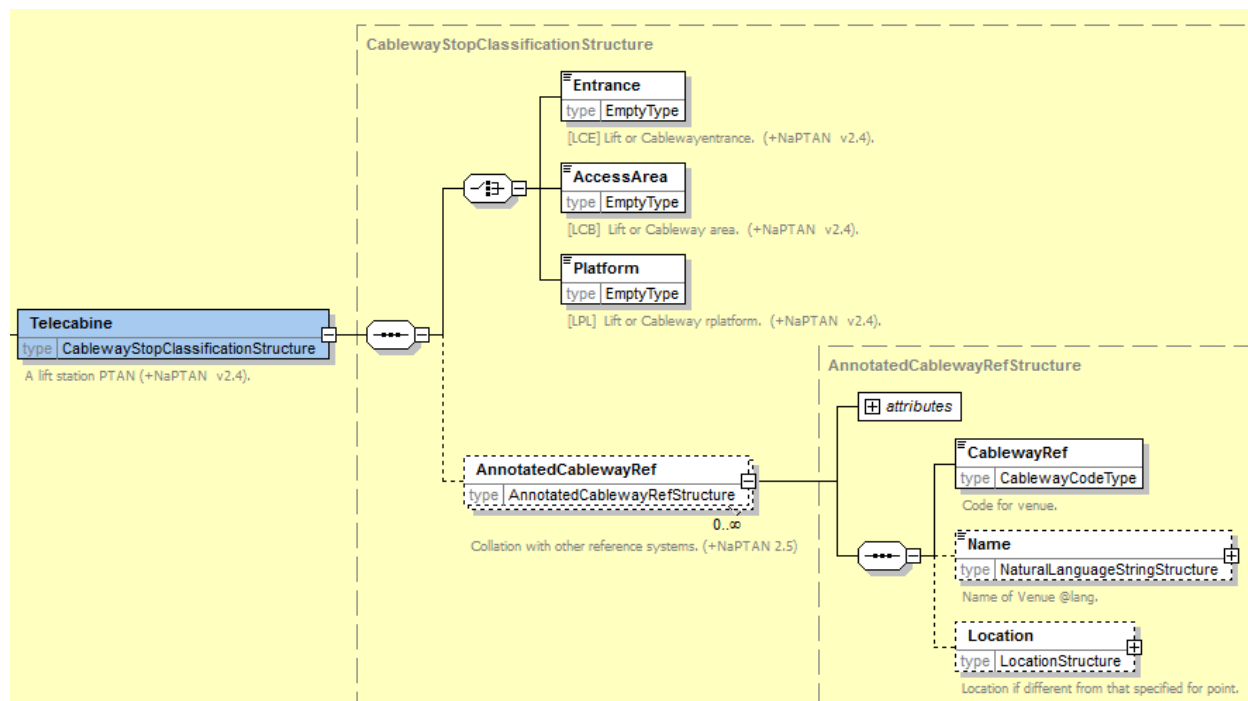

Figure 6-23 – OffStreet / Telecabine Element

6.9 StopAvailability Element

The **StopAvailability** element (Figure 6-24) specifies when the stop is available for use. It comprises one or more **StopValidity** instances, ordered in order of their start dates.

Each **StopValidity** instance comprises:

- A **DateRange**: Period for which status applies
 - **StartDate**: Date from which the specified stop validity status applies
 - **EndDate**: Date at which status ceases to apply. If omitted, state continues indefinitely or until the **StartDate** of the next **Validity**.

A status: one of the following:

- **Active**: Stop is active at its current location.
- **Suspended**: Stop is suspended from use.
- **Transferred**: Stop is suspended from use and activity transferred to the stop indicated by the **StopPointRef**. The referenced stop should be different to the current stop.
- **Note**: Any explanation accompanying the validity period.

Note that the **Status** attribute on **StopPoint** should correspond with any stop validity in effect at the time of export. If no explicit stop validity is present, the stop is assumed to have an implicit validity in effect indefinitely, as indicated by the stop's **Status** attribute: if the **StopPoint / Status** is 'active', the validity status will be **Active**, if the **StopPoint / Status** is 'Inactive' it will be **Suspended**.

From v2.4 the interpretation of StopAvailability is revised to ensure that a stop which may be currently suspended or transferred remains available to be used as a substantive stop point in the registration of a bus service. So StopAvailability is now associated with an ACTIVE stop – and it is an ACTIVE stop, therefore, that can be suspended or transferred (but remains ACTIVE in each case). StopAvailability has no effect on a stop which is already marked as DELETED.

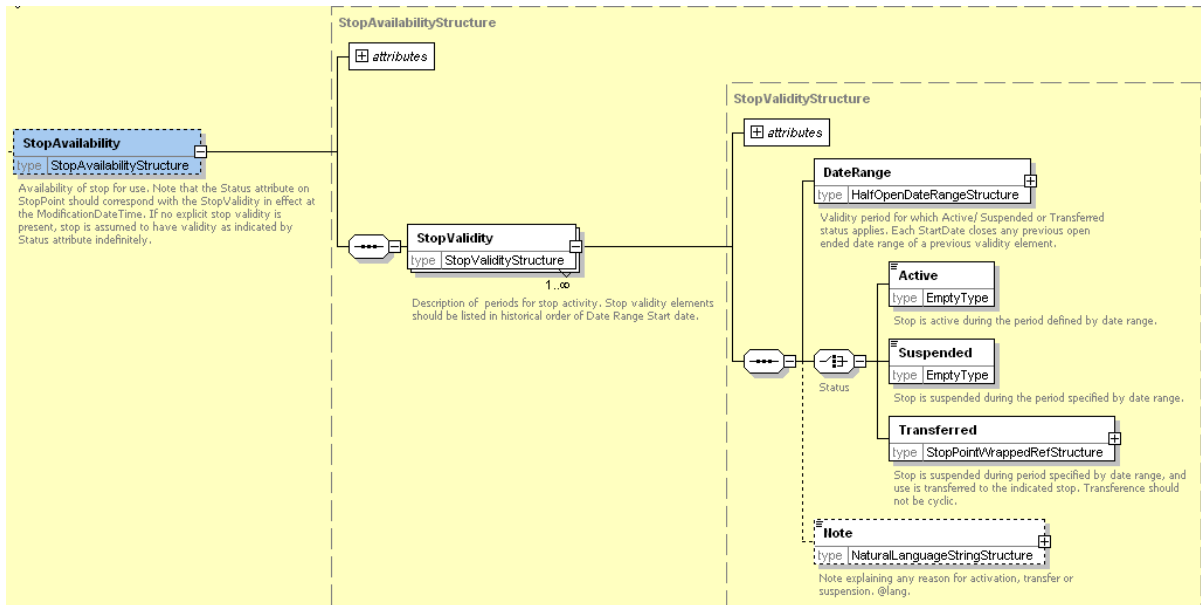

Figure 6-24 – Stop Availability Element

6.10 StopAccessibility Element (V2.5)

The **StopAccessibility** element (Figure 6-25) specifies the accessibility of the stop for mobility impaired users. It comprises an overall assessment and a number of criteria.:

- A **MobilityImpairedAccess**: Overall assessment of the stop for accessibility. This can be used for example to indicate accessible and inaccessible stops on maps and in journey planners. See Limitation Status (Table 6-4) for allowed values. For a topologically simple stop such as an on-street bus stop, this will typically be the same as the **WheelchairAccess** status. For complex stops such as metro and rail stations it requires an overall judgement based on the accessibility of individual platforms. For example a station which requires the use of a flight of steps to reach the main platform would be considered inaccessible.
- **SiteAccessibilityGroup**: General accessibility properties of a location. See below.
- **StopAccessibilityGroup**: Specific accessibility properties of a stop. See below.

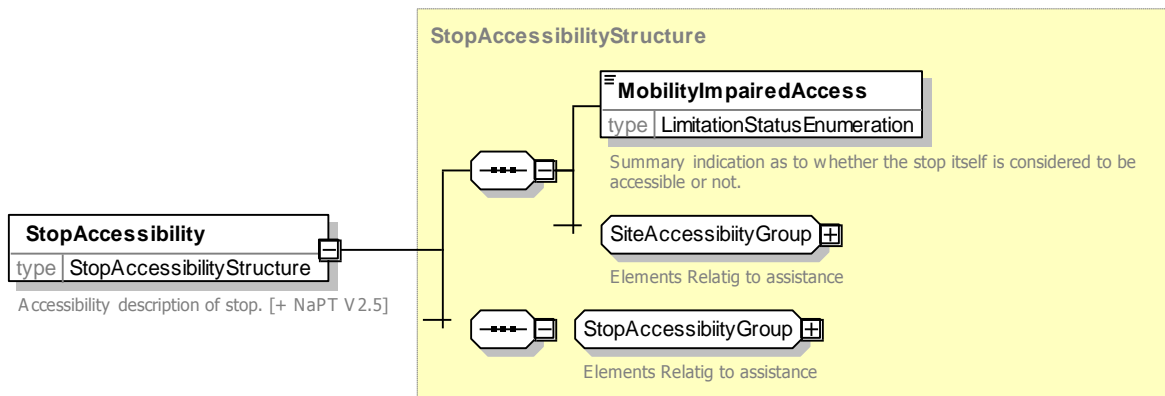

Figure 6-25 – StopAccessibility Element

6.10.1 SiteAccessibility Group (V2.5)

The **SiteAccessibilityGroup** element (Figure 6-26) groups elements specifying the general accessibility of the site for mobility impaired users. It comprises:

Specific assessments:

- **WheelchairAccess:** Whether stop is accessible to wheelchair users. See Limitation Status (Table 6-4) for allowed values. Normally if there is Step free access there will be wheelchair access. However wheelchair access may additionally require assistance, use of a boarding ramp etc.
- **StepFreeAccess:** Whether stop is accessible without the use of steps. See Limitation Status (Table 6-4) for allowed values.
- **EscalatorFreeAccess:** Whether stop is accessible without the use of escalator. See Limitation Status (Table 6-4) for allowed values.
- **LiftFreeAccess:** Whether stop is accessible without the use of lifts. See Limitation Status (Table 6-4) for allowed values. Lift free access may be of concern to sufferers from claustrophobia, autism and other conditions.

Limitation Status (Table 6-4).shows the allowed values for accessibility assessments. Note that a value of unknown should be used if the accessibility is not known.

Value	Description
true	Stop is considered accessible according to criteria.
false	Stop is not considered accessible according to criteria.
partial	Stop is partial accessible according to criteria: some areas are not accessible.
unknown	The accessibility of the stop according to the criteria is not known.
defaultByType	If no explicit value is specified then value will be assumed by stop type. See below.

Table 6-4 – Allowed Values for LimitationStatus

- The Limitation Status includes an “unknown” value which can be used when the accessibility status is not known. It is reasonable to assume that Air, Bus and Coach Stops will usually be accessible even if a value is not specified. See Table 6-5.

	Value to assume if unspecified			
Mode	Wheelchair	StepFree	EscalatorFree	LiftFree
Air	True	unknown	True	unknown
Rail	unknown	unknown	True	True
Metro	unknown	unknown	unknown	unknown
Ferry	unknown	unknown	True	True
Tram	unknown	unknown	True	True
Bus	True	True	True	True
Coach	True	True	True	True

Table 6-5 – Accessibility defaults by mode

Assistance values:

- **AccessVehicle:** Details on accessibility for wheelchair users. See below
- **AssistanceServiceAvailability:** Availability of an assistance service available for disabled users. See Assistance ServiceAvailability (Table 6-6 for allowed values.

Value	Description
none	Assistance service is not available from Operator.
available	Assistance is available from Operator.
availableIfBooked	Assistance is available if booked.
availableAtCertainTimes	Assistance is available at certain times.
unknown	Not known if available.

Table 6-6 – Allowed Values for AssistanceServiceAvailability

- **AssistanceTimes:** Times when assistance is available.
 - **DayType: Type for day and Timeband. See below.**

- **OperatorRef:** Identifier of operator who provides service. This can be used to integrate booking details and other information.
- **AssistanceBookingPhoneNumber:** Phone number to book assistance at the stop.
- **InfoUrl:** Public URL with information about accessibility at the stop.

Further details

- **Note:** Any comment accompanying the accessibility.

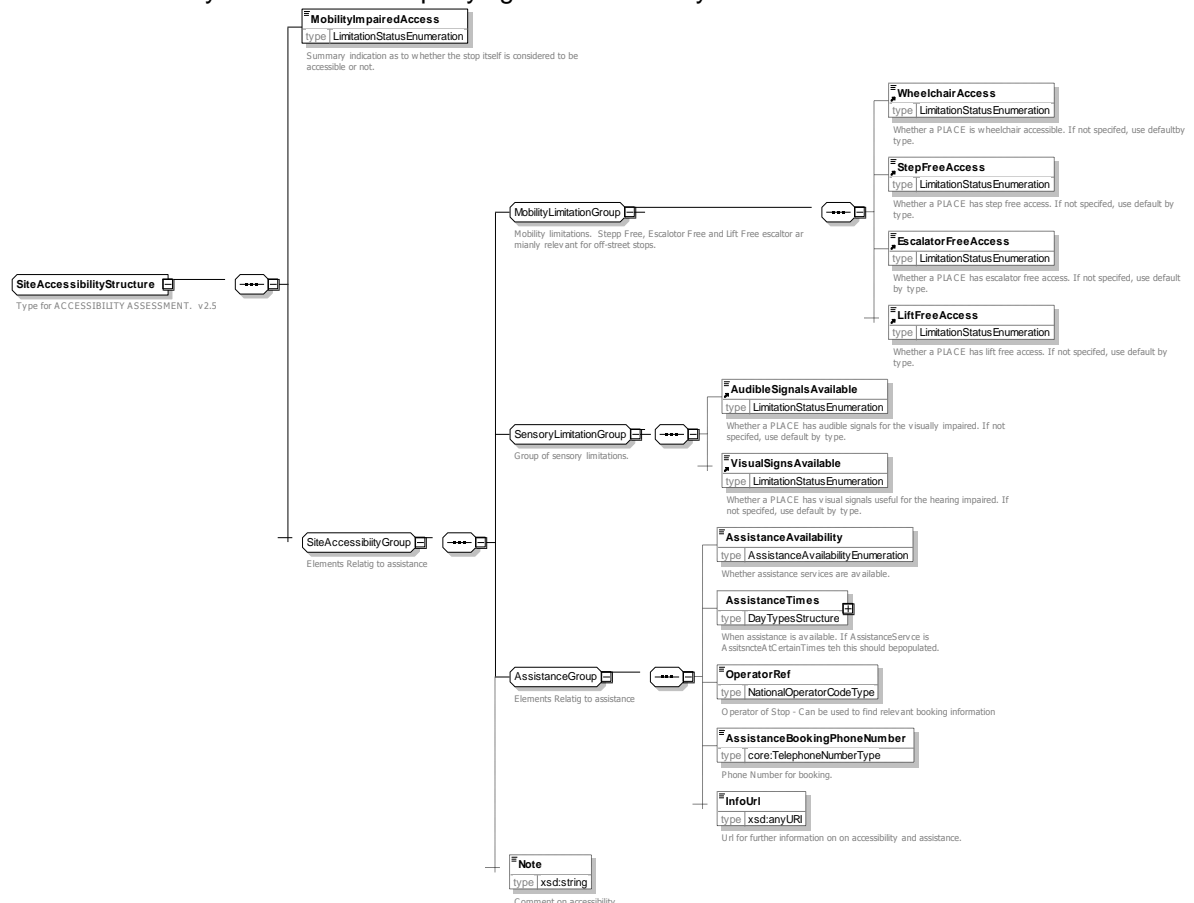

Figure 6-26 – SiteAccessibilityGroup Group

6.10.1 StopAccessibility Group (V2.5)

The **StopAccessibility** element (Figure 6-27) groups elements specifying the general accessibility of the site for mobility impaired users. It comprises:

- The **AccessVehicle** element describes some properties relevant for wheelchair access to vehicles at the stop. See below
- **ServicesAtStopAreNormallyAccessible:** Whether services at the stop are normally accessible, for example the vehicle type has low floor, a wheelchair hoist, etc. This is a default value for indicative guidance only. It may be that specific services are not accessible. See Limitation Status (Table 6-4) for allowed values.

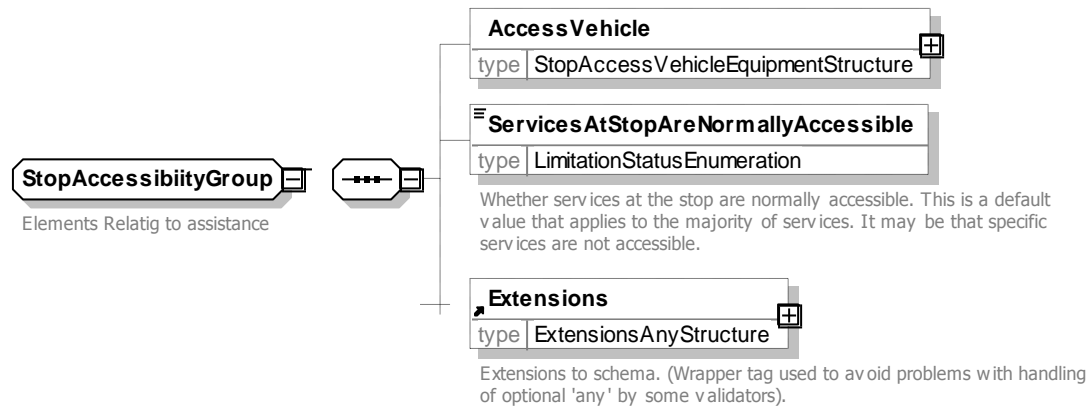

Figure 6-27 – StopAccessibilityGroup Group

6.10.2 AccessVehicle Element

The **AccessVehicle** element (Figure 6-28) describes some properties relevant for wheelchair access at the stop.

- **LowFloor**: Normal access at stop is with a low floor vehicle.
- **Hoist**: Normal access to vehicle at stop is with a hoist.
- **HoistOperatingRadius** : Distance from vehicle needed to operate hoist.
- **Ramp**: Normal access to vehicle at stop is with a ramp.
- **RampBearingCapacity** : Maximum weight allowed on ramp or Hoist.
- **NumberOfSteps** : Number of steps to board.
- **BoardingHeight** : Height of vehicle to board above platform
- **GapToPlatform** : Gap between carriage and platform. Where this varies this should be for the best boarding position.
- **WidthOfAccessArea** : Width of access area – e.g. train door.
- **HeightOfAccessArea** : Height of access area – e.g. train door.
- **AutomaticDoors** : Whether vehicle or carriage has automatic doors
- **SuitableFor** : Mobility need for which access is suitable. See Table 6-7 below.

Value	Description
<i>wheelchair</i>	Wheelchair
<i>assistedWheelchair</i>	Wheelchair pushed by companion
<i>motorizedWheelchair</i>	Motorized Wheelchair
<i>mobilityScooter</i>	Small mobility Scooter: A Class 2 scooter under the CPT classification with 3 or 4 wheels, not more than 600mm wide and 1000 mm long and with a turning radius not exceeding 1200mm. Normally weigh about 65 kg.
<i>roadMobilityScooter</i>	Large Mobility Scooter: A Class 3 scooter under the CPT classification. Class 3 scooters are bigger and have light for road use. They are not normally allowed on buses.
<i>walkingFrame</i>	Walking Frame
<i>restrictedMobility</i>	Restricted Mobility
<i>normal</i>	Normal mobility

Table 6-7 – Allowed Values for *MobilityNeed*

- **AssistanceNeeded** : Nature of assistance needed to board See (Table 6-8).

Value	Description
<i>levelAccess</i>	Level access – passenger can propel themselves
<i>rampRequired</i>	Assistance with ramp needed.
<i>hoistRequired</i>	Assistance with hoist needed.
<i>unknown</i>	Not known.

Table 6-8 – Allowed Values for *AssistanceNeeded*

- **AssistedBoardingLocation** : Whether boarding has to be done at a specific position on the platform. See Table 6-9).

Value	Description
<i>boardAtAnyDoor</i>	Boarding can be at any location
<i>boardOnlyAtSpecifiedPositions</i>	Boarding must be at specific positions on platform
<i>unknown</i>	Not known.

Table 6-9 – Allowed Values for AssistedBoardingLocation

- **GuideDogsAllowed** : Whether guide dogs are allowed.

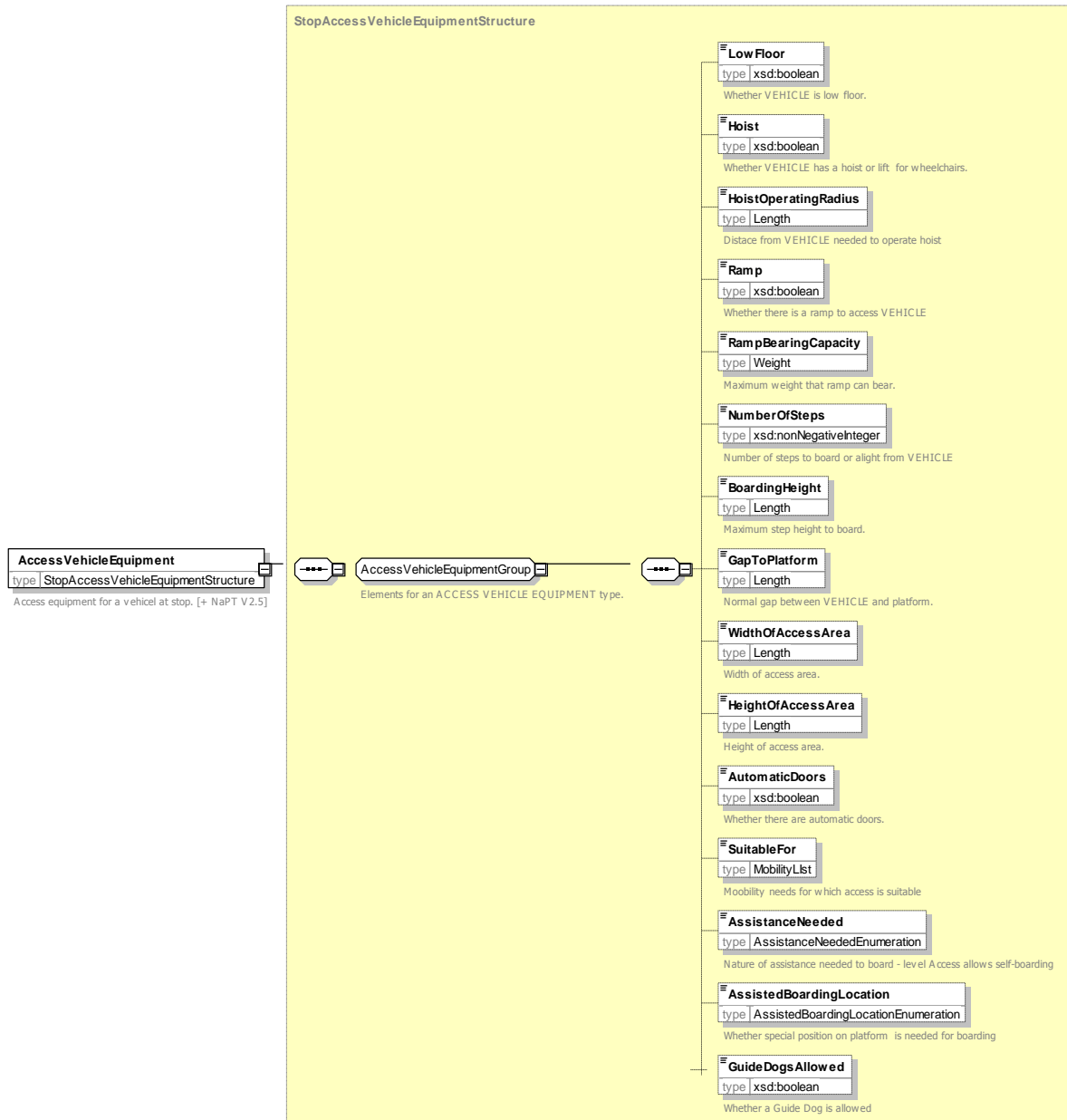

Figure 6-28 – AccessVehicle Element

6.10.3 DayType Element

The **DayType** element (Figure 6-29) describes a day type including Timeband.

- **DaysOfWeek:** The days of week can be specified **Monday Tuesday, Wednesday, Thursday, Friday, Saturday, Sunday MondayToFriday**
- **PublicHolidays:** The bank holidays to which the day type applies.
- **Timeband:** Timeband within day.
 - **StartTime:** Time that band starts.
 - **EndTime :** Time that band ends.
 - **DayOffset:** Day of set if **EndTime** is in the next day. 0-same day.

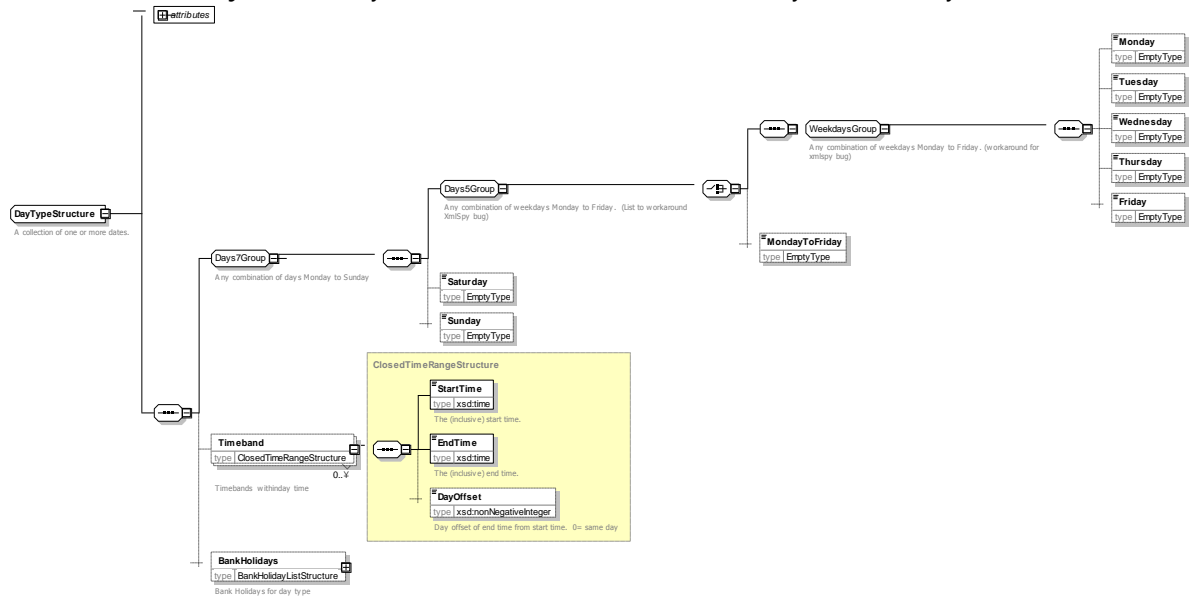

Figure 6-29 – DayType Element

6.10.4 BankHolidays Element

The **BankHolidays** element (Figure 6-30) specifies the bank holidays that apply to a **DayType**.

- **AllBankHolidays:** Other elements are all assumed.
- Specific holidays **ChristmasDay, BoxingDay, GoodFriday**, etc.



Figure 6-30 – BankHolidays Element

6.11 StopArea Element

A **StopArea** (Figure 6-31) groups stops. A **StopArea** comprises the following elements:

- **StopAreaCode:** Unique NaPTAN system identifier of stop area.
- **PrivateCode:** Unique identifier with which to associate a NaPTAN **StopArea** with other identifiers used by other systems. This element is to support the general exchange of stop data, and is not part of the NaPTAN database. For example when **StopArea** definitions are exchanged in *TransXChange* or for AVL systems, it may be useful to annotate them with private identifiers.
- **ParentAreaRef:** Code of parent **StopArea**. Stop areas may be organised into a hierarchy (see earlier discussion of the NaPTAN model). Each **StopArea** can have a single parent, which may in turn have a parent and further ancestors. Each **StopArea** can be referenced as a parent by many other stop areas, i.e. have many children, each of which may have further descendants. References must not be cyclic, i.e. a **StopArea** cannot be its own ancestor or descendant.

- **Name:** Name of the **StopArea**.
- **AdministrativeAreaRef:** NPTG **AdministrativeArea** responsible for managing stop area.
- **StopAreaType:** Type of **StopArea**. See Table 6-10.

Value	Description	Use
<i>GAIR</i>	Airport Building.	1.0
<i>GFTD</i>	Ferry Terminal or Dock Building	1.0
<i>GRLS</i>	Rail Station.	1.0
<i>GTMU</i>	Tram / Metro / Underground Station.	1.0
<i>GBCS</i>	Bus / Coach Station.	1.0
<i>GCCH</i>	Coach Service Coverage	2.0
<i>GCLS</i>	On-street Bus / Coach / Trolley stops cluster (more than two stops in the same general location).	1.0
<i>GLCB</i>	Lift or Cable car station	+NaPT v2.4
<i>GPBS</i>	On-street Bus/ Coach / Trolley stop pair (one in each direction).	1.0
<i>(GMLT)</i>	Multimode Interchange	DEPRECATED 2.0
<i>(GOTH)</i>	Other Interchange.	DEPRECATED 2.0

Table 6-10 – Allowed Values for StopArea Classification

- **Location:** Spatial location of the centre of the area.
 - **Location** is given as point with an optional approximate precision to indicate the **StopArea** size. An exact polygon of the **Stop Area**'s boundaries is not provided. The **StopArea** can be considered to include at least the area defined by the **Place / Location** points all of its own immediate **StopPoint** member instances.
 - In addition to this **Location**, the **StopArea** is considered to be associated with all the NPTG localities (and alternative localities) of its member stops. This is a derived relationship. Different stops in a given stop area may belong to different **NptgLocality** instances, although it is best to avoid this if possible..

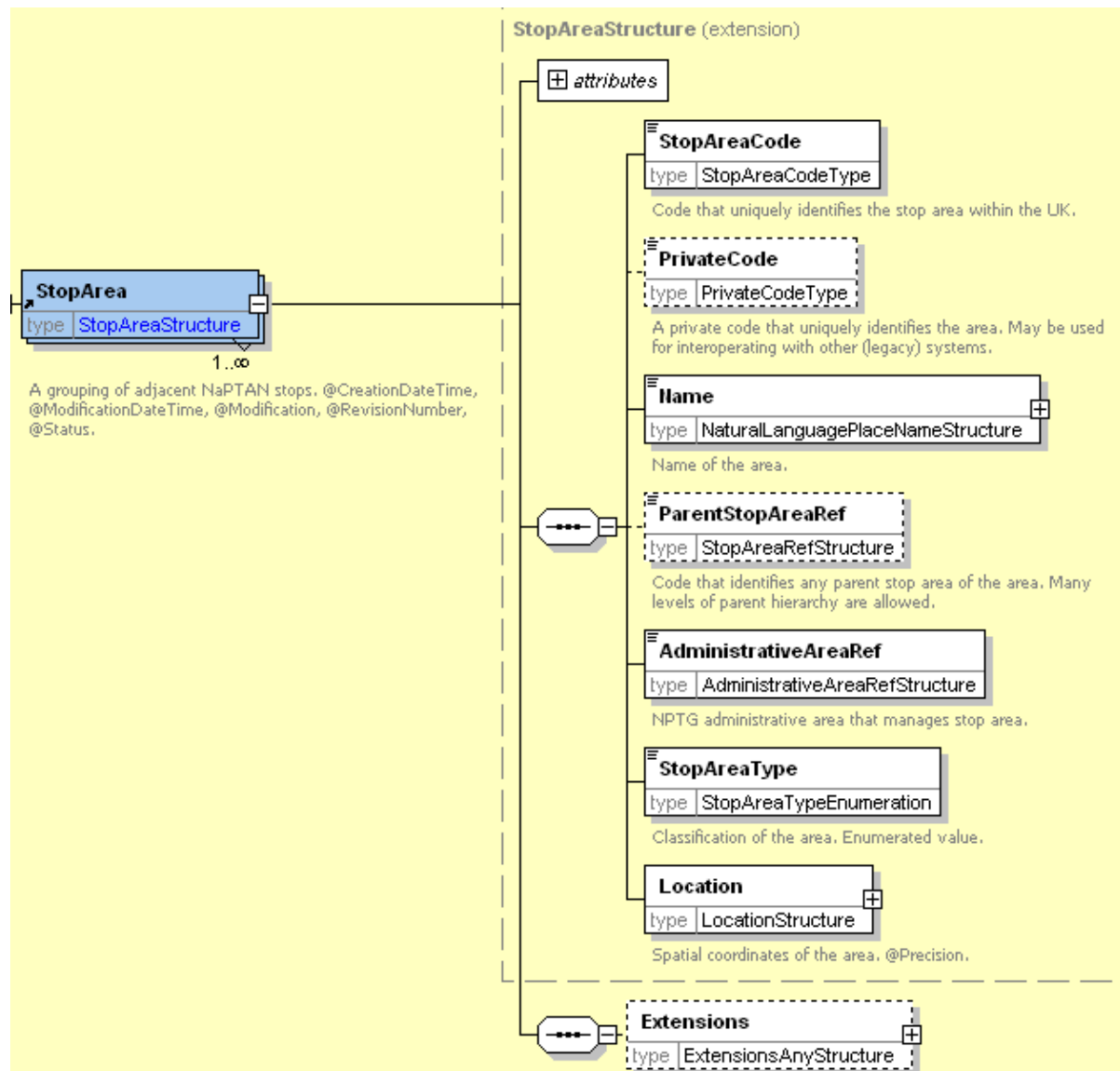

Figure 6-31 – StopArea Element

6.12 Network Element (+NaPT v2.5)

A **Network** (Figure 6-32) groups the **TariffZones** of a fare scheme. A **Network** comprises the following elements:

- **NetworkCode:** Unique *NaPTAN* identifier of *Network*.
- **Name:** Name of the *Network*.
- **ShortName:** Name of the *Network*.
- **Modes:** Transport Modes of the *Network*.
- **AdministrativeAreaRef:** *NPTG AdministrativeArea* responsible for managing *Network*.
- **TariffZones:** A list of *TariffZone* elements that belong to the *Network*'s Fare scheme.

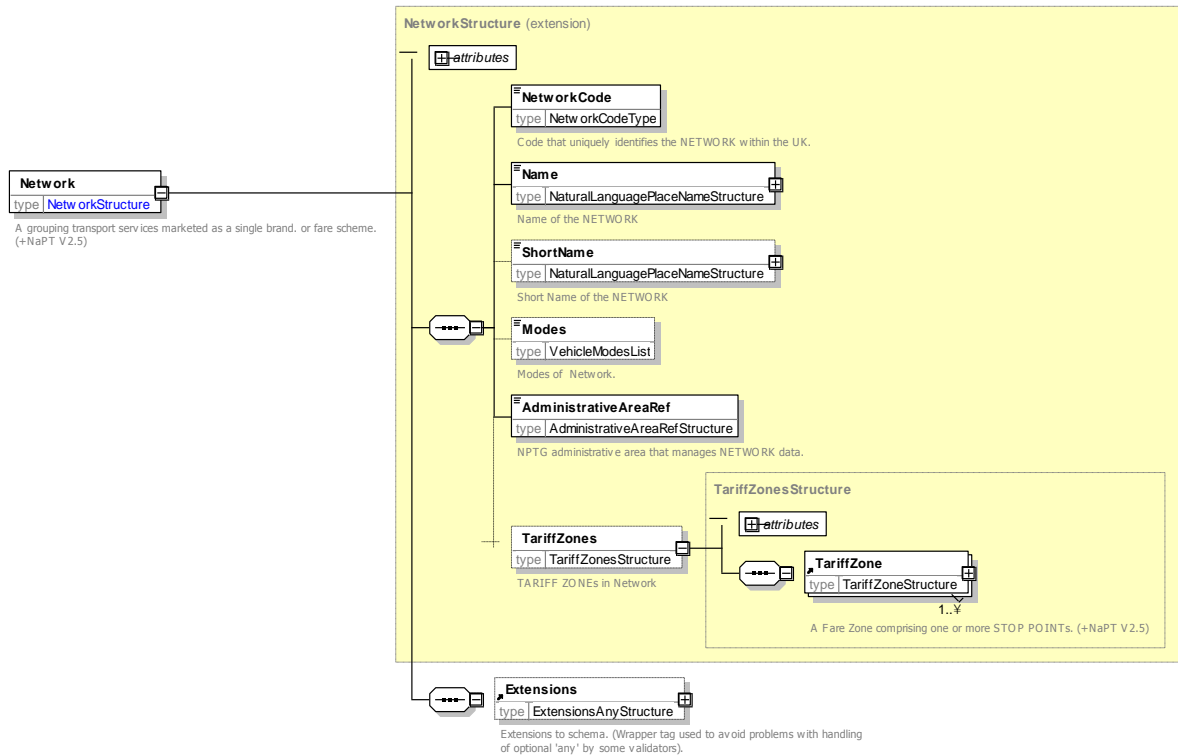

Figure 6-32 – Network Element

6.13 TariffZone Element (+NaPT v2.5)

A **TariffZone** (Figure 6-32) identifies an individual **TariffZone**. A **TariffZone** comprises the following elements:

- **TariffZone Code:** Unique NaPTAN identifier of Network., for example "TfL:ZONE1"
- **Name:** Name of the **TariffZone**.
- **ShortName:** Name of the **TariffZone**.

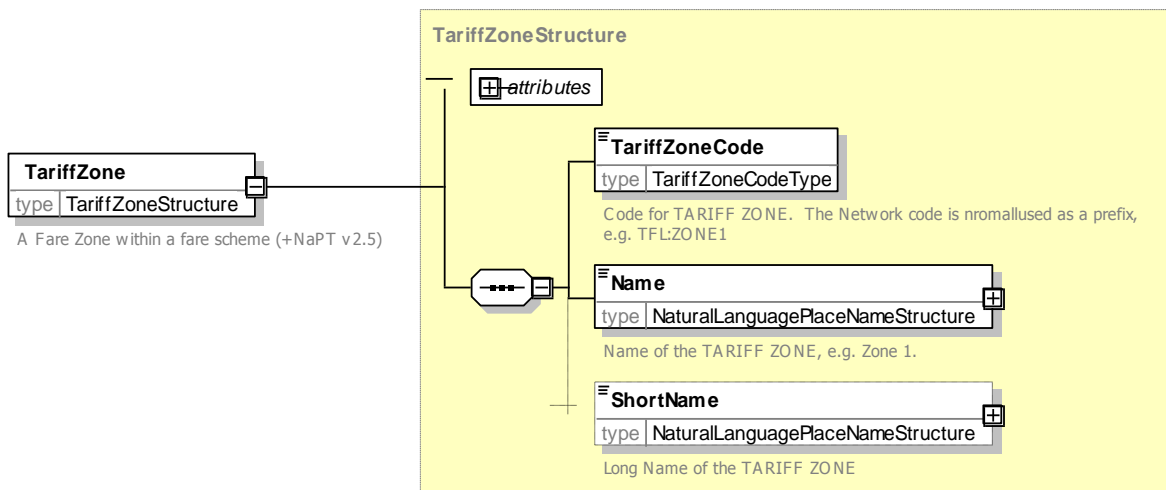

Figure 6-33 – TariffZone Element

6.14 PointOfInterest Element (+NaPT v2.5)

A **PointOfInterest** (Figure 6-32) identifies an individual **PointOfInterest**. A **PointOfInterest** comprises the following elements:

- **AtcoCode**: Unique NaPTAN system identifier of **PointOfInterest**. Codes are unique within the NaPTAN database for Great Britain. **PointOfInterest** codes begin with “8”.
- **NaptanCode**: Unique NaPTAN public identifier of **PointOfInterest**.
- **PrivateCode**: Unique identifier for associating stop with other identifiers used by other systems.
- **SiteDescriptionGroup**: Groups together elements describing the name and whereabouts of a **PointOfInterest**. See earlier.
- **PointOfInterestClassification**: categorizes the **PointOfInterest**. See below.
- **AdministrativeAreaRef**: NPTG **AdministrativeArea** responsible for managing data about the point of interest.
- **Notes**: Any notes about the Point of Interest.
- **Public**: Whether Point of Interest is for use by general public. Default is true.
- The **SiteAccessibility** element specifies the accessibility assessment of the point of interest for use. In journey planners. See earlier.

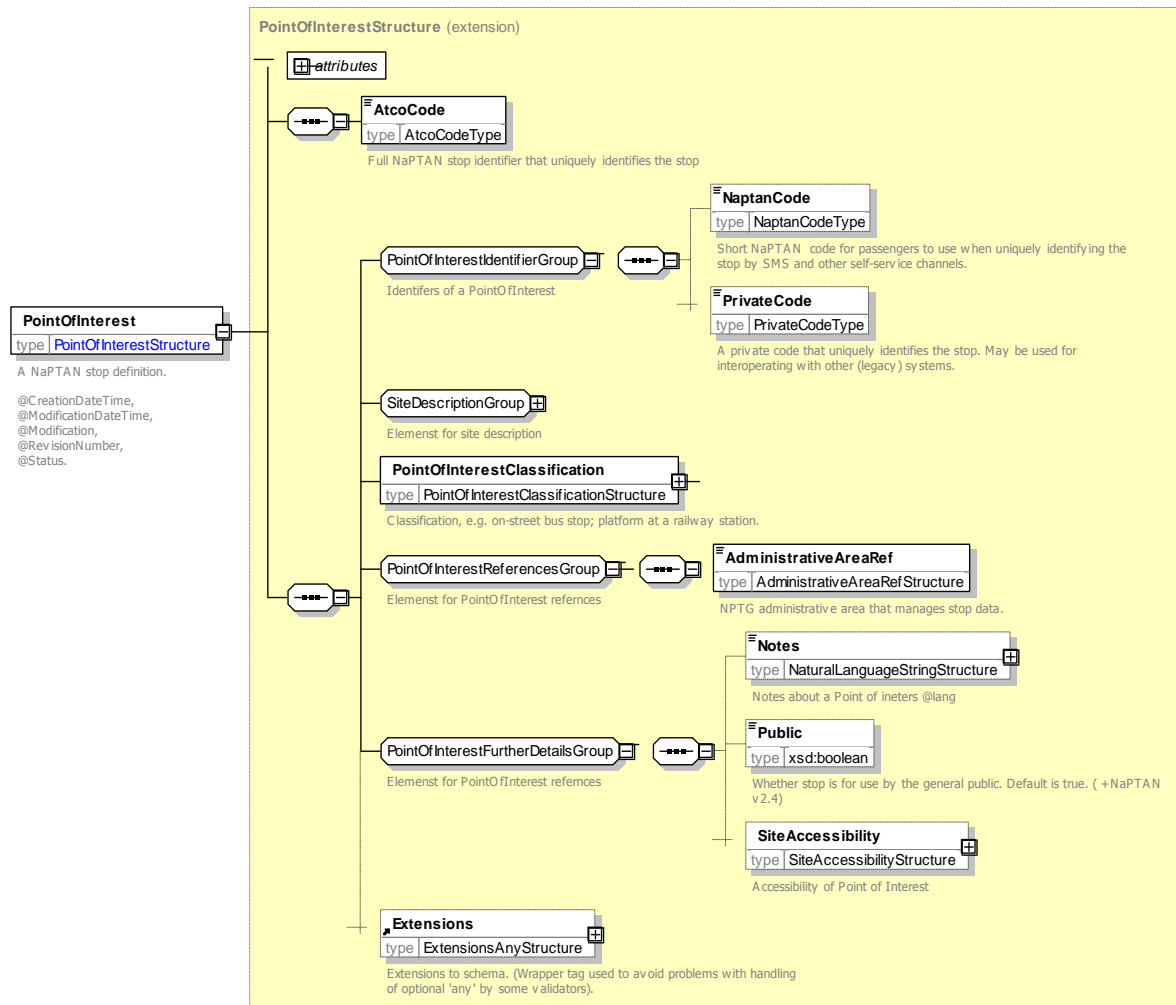

Figure 6-34 – PointOfInterest Element

6.15 PointOfInterestClassification / Off-Street Elements

6.15.1 PointOfInterestClassification Element (+NaPT V2.5)

The **PointOfInterestClassification** element (Figure 6-35) categorises a point of interest.

- **Venue Type:** Point is an entrance. (Type 'PIE').
- **Entrance:** Point is an entrance. (Type 'PIE').
- **AccessArea:** Point is an access area. (Stop type 'POI').
- **EndArea:** Point is destination area within the point of interest, such as a particular grandstand. (Venue Type 'PSP').

The point may also be associated with other elements:

- **AnnotatedVenueRef:** Translates *NaPTAN* stop point into an external reference.
 - **VenueRef:** External code for the venue.
 - **Name:** Short name of the venue location.
 - **Location:** Optional Location of the venue if different from the NaPTAN value.
 - **Category:** Arbitrary categorisation of the element.

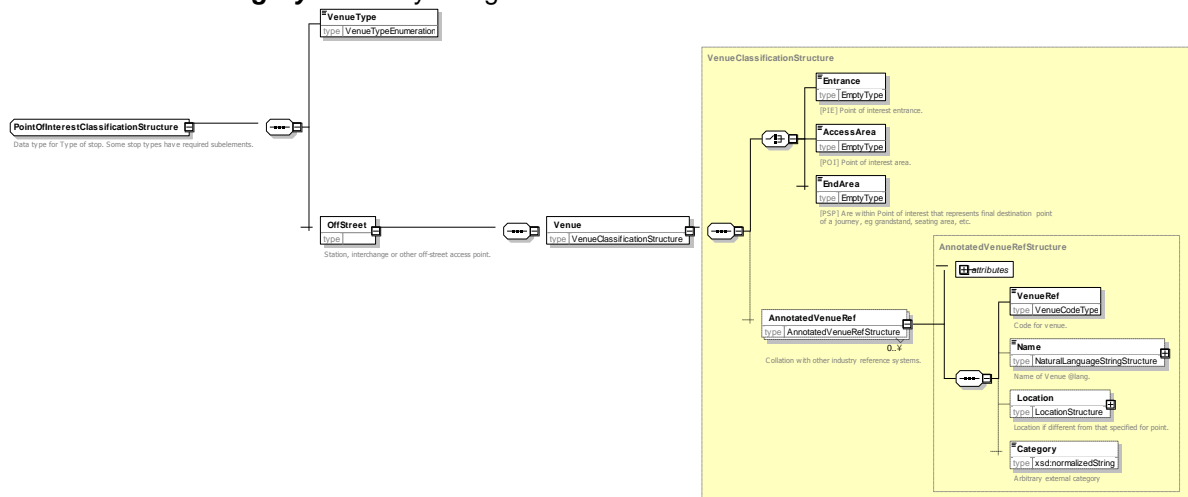

Figure 6-35 – PointOfInterestClassification Element

7 NPTG DISCOVERY SCHEMA, STRUCTURE AND ELEMENTS

NPTG Discovery XML schema (*Figure 7-1*) describes web services associated with NPTG entities as a model of XML elements, contained within an ***NptgDiscovery*** root element. It references entities defined in the *NPTG* schema.

7.1 NptgDiscovery Root Element

7.1.1 NptgDiscovery Element Attributes

The ***NptgDiscovery*** root element uses the NaPT standard schema attributes for versioning, and also has standard attributes to indicate the default data reference systems used: See discussion of versioning later on.

- *Versioning*
 - ***CreationDateTime***: Timestamp of document creation date and time.
 - ***ModificationDateTime***: Timestamp of document last modification date, and time.
 - ***FileName***: Name of file containing the document as created. (If the document is renamed this will not change).
 - ***Modification***: Nature of change: *new*, *revision*. Normally 'revision'. Other possible values are *delete* or *archive*.
 - ***RevisionNumber***: Optional sequence number for versioning overall document content.
 - ***SchemaVersion***: Schema version identifier used for the document content model.
- *Data Reference*
 - ***Xml:lang***: Default language of document. ISO language identifier. Default is English.
 - ***LocationSystem***: Data system to use for location coordinate references within the document: *WGS84* or *Grid*. Normally *Grid* is used.

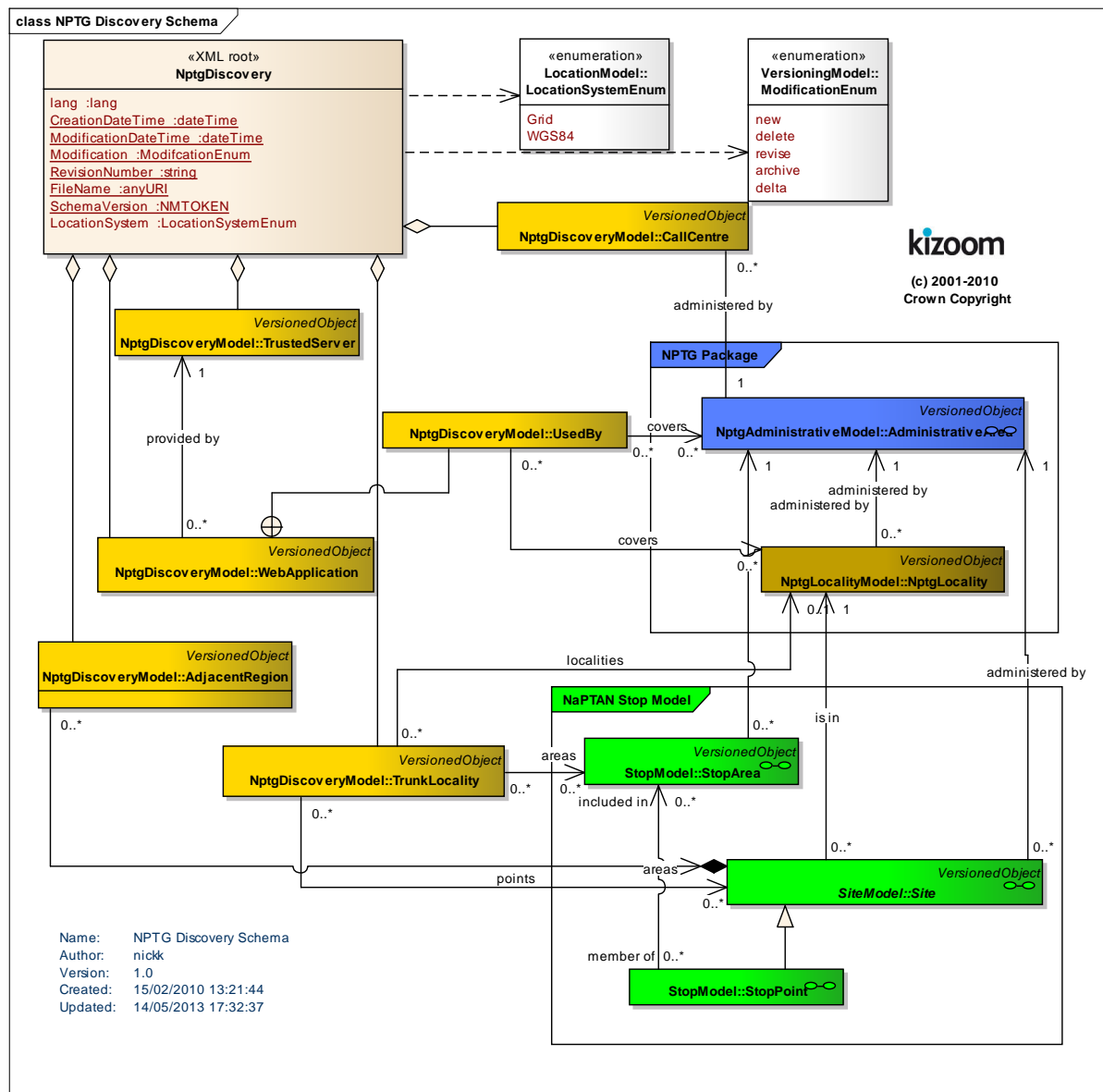

Figure 7-1 – UML Diagram of the NPTG Discovery Schema

7.1.2 NptgDiscovery Child Elements

The **NptgDiscovery** element (Figure 7-2) contains the following child elements, each of which is described in more detail later in this document:

- **CallCentres:** A collection of **CallCentre** elements, used to represent available voice information services.
- **WebApplications:** A collection of **WebApplication** elements, used to represent available on-line information services.
- **TrustedServers:** A collection of **TrustedServer** elements, used to represent available access points to information services.
- **AdjacentRegionPoints:** A collection of **AdjacentRegionPoints** used to define shared boundary points between regions for journey planning purposes.
- **TrunkLocalities:** A collection of **TrunkLocality** elements used to define access points to the Trunk network for journey planning purposes.

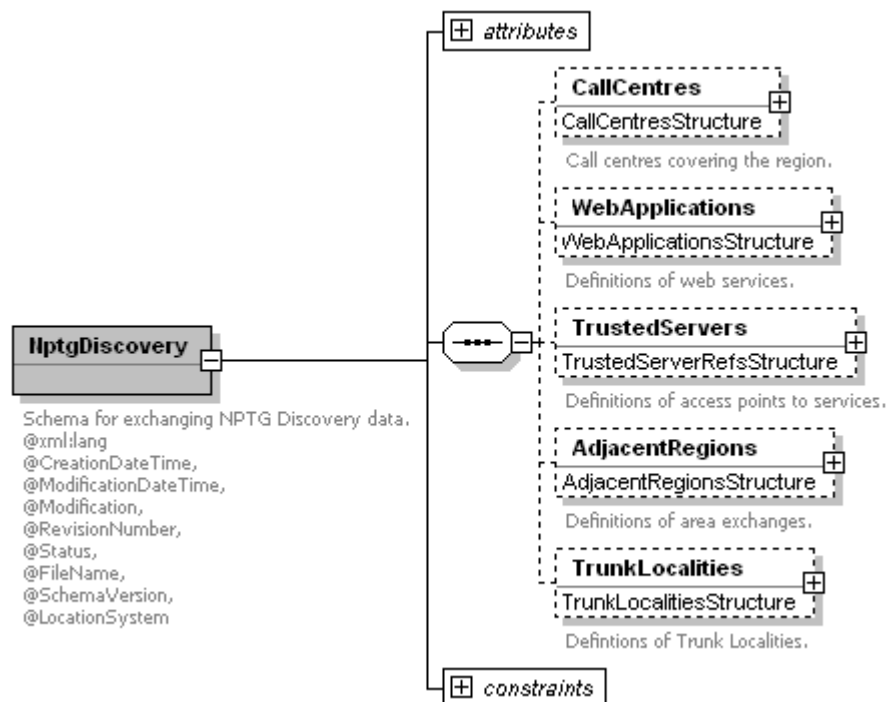

Figure 7-2 – NptgDiscovery Root Element

7.2 WebApplication Element

A **WebApplication** (Figure 5-7) represents an available system resource.

- **WebApplicationCode:** Unique identifier of the service.
- **WebApplicationClassification:** Classifier of the service. See Table 7-1.

Value	Description
<i>JourneyWeb</i>	Supports JourneyWeb Protocol
<i>RtigXml</i>	Supports RtigXml Protocol
<i>Traveline</i>	Online WWW Journey Planner
<i>Departures</i>	Online WWW Stop Departures
<i>SIRI</i>	Supports SIRI for real-time information
<i>NeTEx</i>	Supports NeTEx Protocol (in the future)
<i>Other</i>	Other unspecified service

Table 7-1 – Allowed Values for WebApplicationClassification

- **CapabilityClassification:** Capability string.
- **Description:** Description of application.
- **Staging:** Whether service is for demo, test, or production.
- **Version:** Version number of service.
- **URL:** URL with which to access the service.

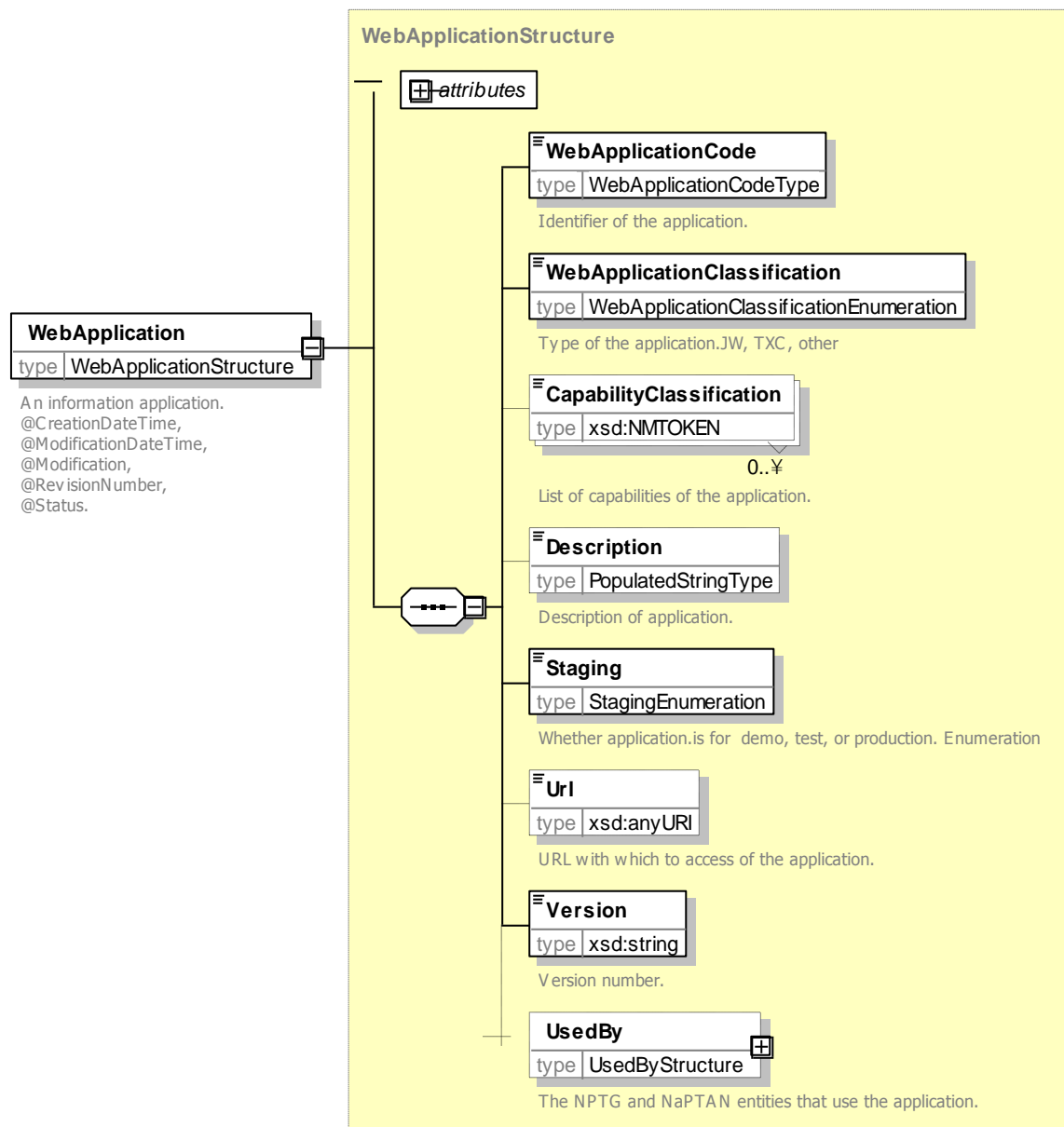

Figure 7-3 – WebApplication Element

7.2.1 UsedBy Element

A **UsedBy** (Figure 5-7) associates an available system resource with an *NPTG* or *NaPTAN* entity.

- **RegionRefs:** Regions associated with service. Collection of **RegionRef** instances.
- **AdministrativeAreaRefs:** Administrative Areas associated with service, if different from Region. Collection of **AdministrativeAreaRef** instances.
- **NptgLocalityRefs:** *NPTG* Localities associated with service, if different from Administrative Area. Collection of **NptgLocalityRef** instances.
- **StopPointRefs:** Stops associated with service, if different from *NPTG* Locality. Collection of **StopPointRef** instances.

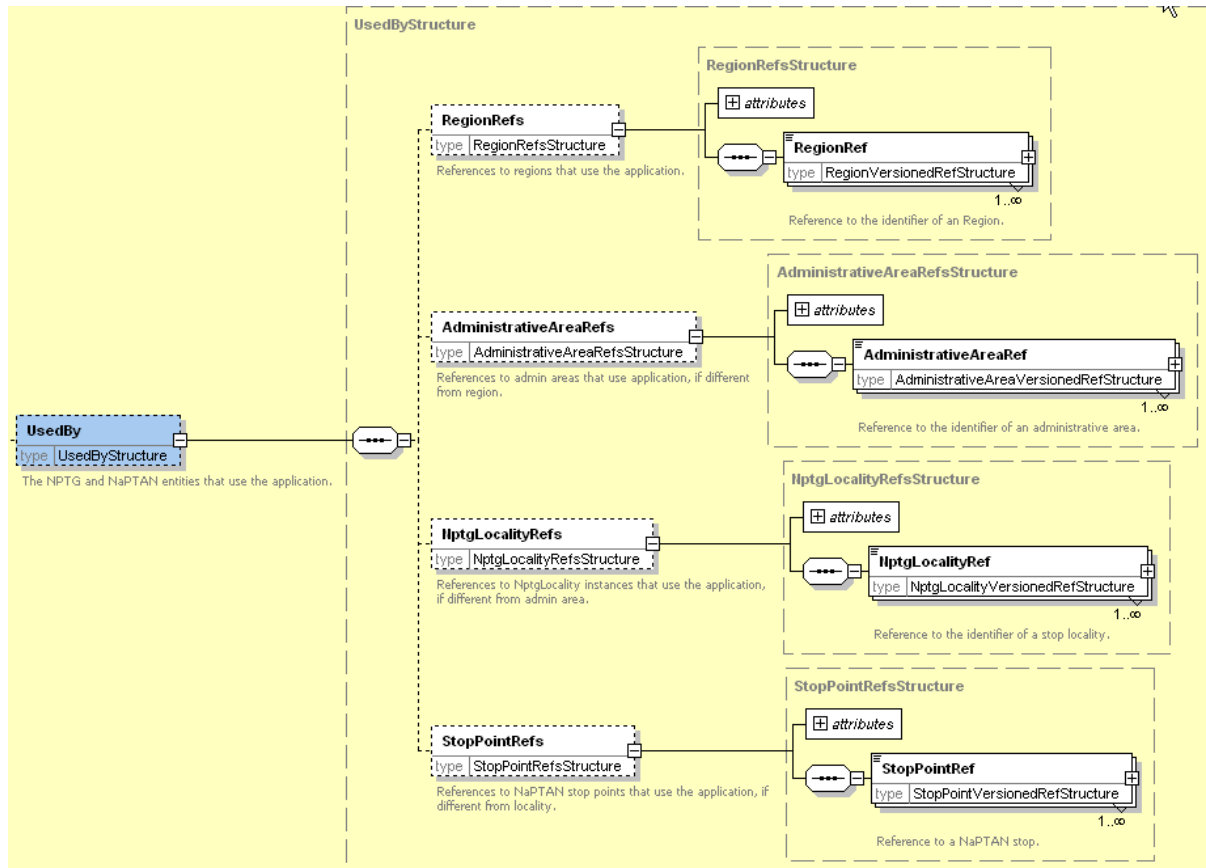

Figure 7-4 – UsedBy Element

7.3 TrustedServer Element

A **TrustedServer** (Figure 7-5) represents a point of access to the web services described by **WebApplication** instances.

- **ServerCode**: Unique identifier of the district.
- **IpAddressRange**: Range of IP addresses of access point.
 - **FirstIp**: First IP number in range. Standard internet address got example, 212.04.123.17.
 - **LastIp**: Last IP number in range.

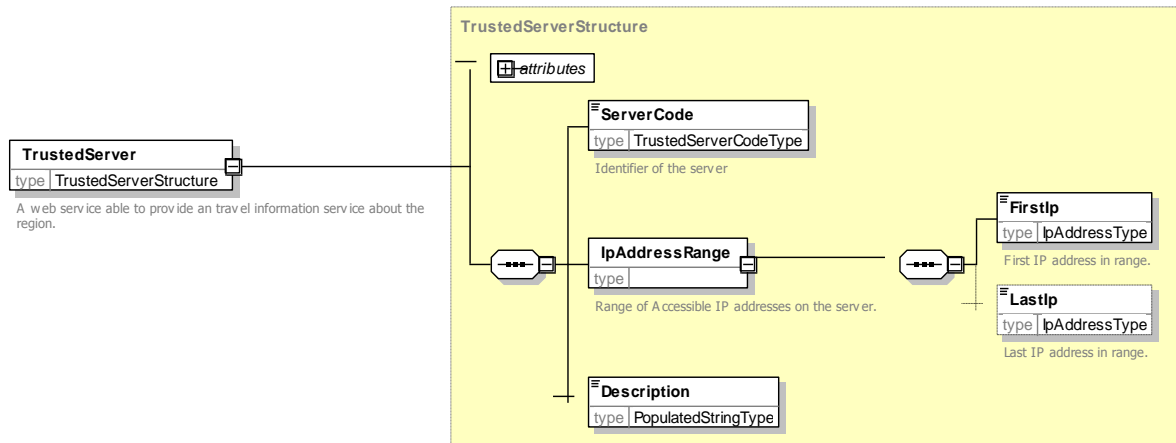

Figure 7-5 – TrustedServer Element

7.4 AdjacentRegionPoint Element

An **AdjacentRegionPoint** (Figure 7-6) is a different type of exchange point, and are used to establish shared boundary points for journey planning purposes. **AdjacentRegionPoint** instances are grouped within an **AdjacentRegionPoints** container. Each point comprises:

- **StopPointRef**: NaPTAN system identifier, i.e. **AtcoCode** of exchange point.
- **FromRegionRef**: Identifier of **Region** that shares point with **Region** identified by **ToRegionRef**.
- **ToRegionRef**: Identifier of **Region** that shares point with **Region** identified by **FromRegionRef**.
- **Location**: Spatial coordinates of point.

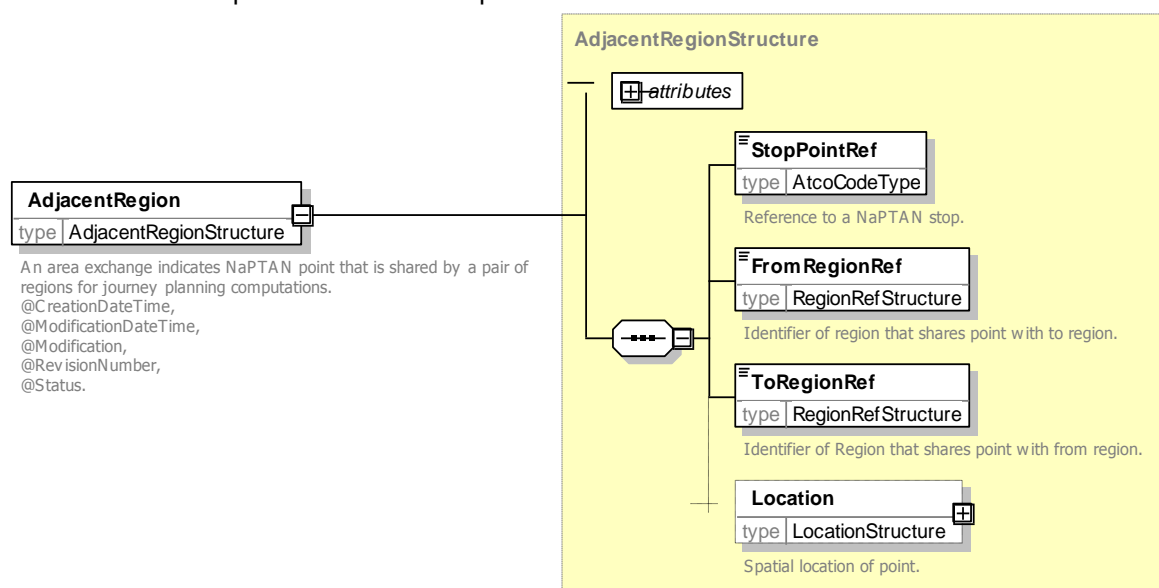

Figure 7-6 – AdjacentRegionPoint Element

7.5 CallCentre Element

A **CallCentre** element (Figure 7-7) represents a call centre providing travel information about a **Region** or **Regions**

- **CallCentreCode**: Unique NPTG code for **CallCentre**.
- **Name**: Name of call centre.
- **RegionRef**: Identifier of region of **CallCentre**.
- **AdditionalRegions**: Additional regions that the CallCentre. .
- **AdministrativeArea**: References to One or more **AdministrativeArea** covered by call centre.
- **Availability**: Opening hours for call centre. See **Availability** Below
- **PublicTelephone**: Public telephone contact number for call centre. See **TelephoneContactStructure** below.
- **DirectTelephone**: Ex-directory telephone contact number for call centre. See **TelephoneContactStructure** below.
- **ContactEmail**: Email contact address for call centre.
- **Notes**: Notes attached to call centre.

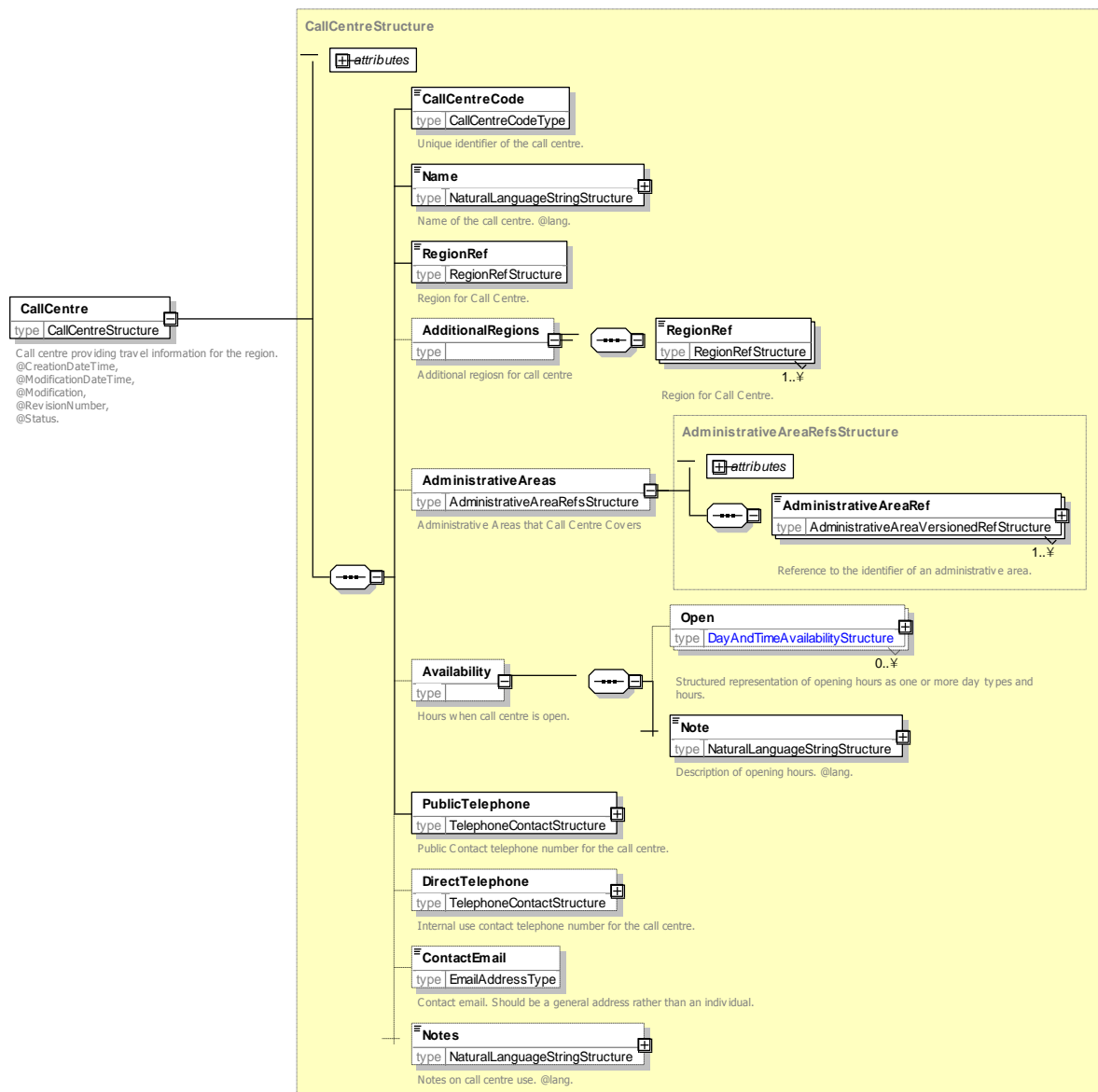

Figure 7-7 – CallCentre Element

7.5.1 Availability Element

The **Availability** element (Figure 7-8) specifies when the call centre is open. It comprises:

- **Open:** One or more opening times for the call centre. Each time consist of a day type and an **OpeningHours**.
 - ❖ **DayTypes** the days when the call centre is open. See **DayTypes**.
 - ❖ **Season:** Any seasons for which specified opening hours apply – if none, all seasons. One or more of **Spring, Summer, Autumn, Winter**.
 - ❖ **HolidayTypes** the holiday days when the call centre is open. See **HolidayTypes**.
- **Note:** Text description of availability.

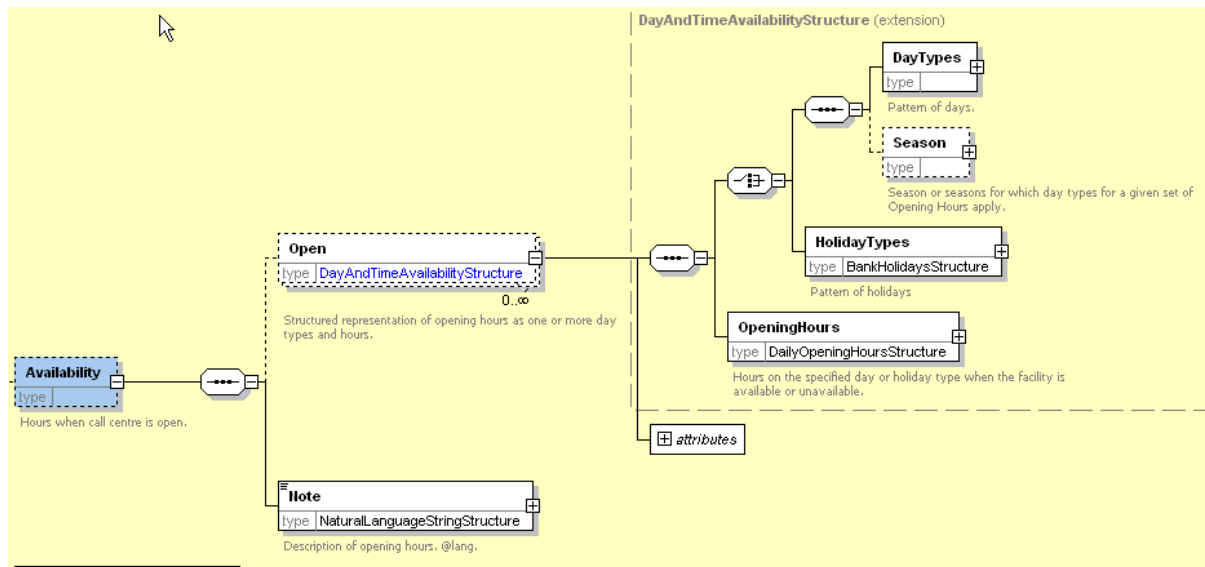

Figure 7-8 – CallCentre / Availability Element

7.5.2 Day Types Element

The **DayTypes** element (Figure 7-9) specifies the days when a service is available or not available (e.g. when a call centre is open). It comprises named day types and day type combinations.

- **Monday, Tuesday, Wednesday, Thursday, Friday, Saturday, Sunday.**
- **NotMonday, NotTuesday, NotWednesday, NotThursday, NotFriday, NotSaturday, Sunday.**
- **MondayToFriday, MondayToSaturday, MondayToSunday, Weekend.**

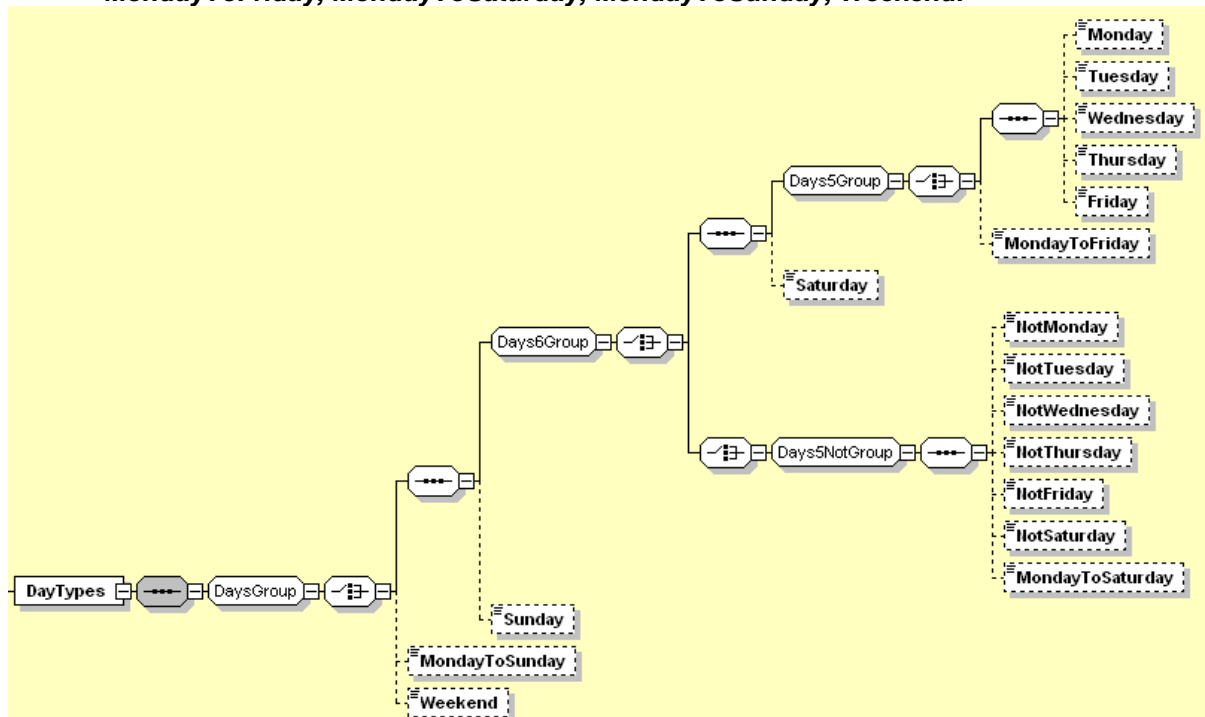

Figure 7-9 – DayTypes Element

7.5.3 Holiday Types Element

The **HolidayTypes** element (*Figure 7-10*) specifies the holiday days when a service is available or not available (e.g. when a call centre is open). It comprises named day and day combinations:

- **Christmas, BoxingDay, NewYearsDay, Jan2ndScotland, StAndrewsDay**
- **ChristmasEve, NewYearsEve,**
- **DisplacementHolidays**
- **ChristmasDayHoliday, BoxingDayHoliday, NewYearsDayHoliday, Jan2ndScotlandDayHoliday, StAndrewsDayHoliday,**
- **GoodFriday, EasterMonday, MayDay, AugustBankHoliday, Spring Bank, AugustBankHolidayNotScotland.**
- **AllBankHolidays, AllBankHolidaysExceptChristmas, HolidayMondays**
- **Other PublicHoliday:**
 - ❖ **Description:** Description of holiday.
 - ❖ **Date:** Date of other holiday.

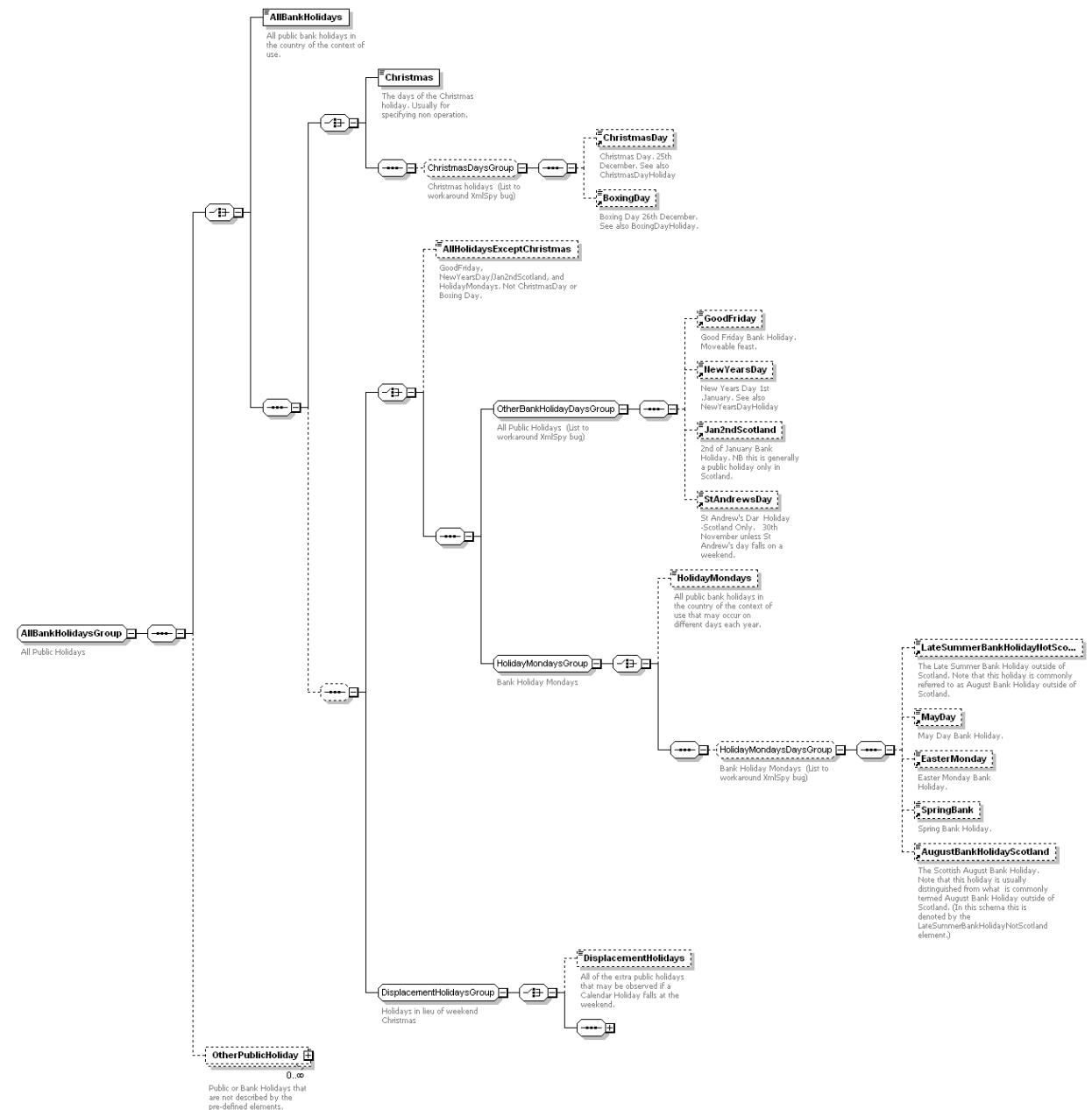

Figure 7-10 – HolidayTypes Element

7.5.4 OpeningHours Element

The **OpeningHours** element (Figure 7-11) specifies the times of day when a service is available or not available (e.g. when a call centre is open). It comprises:

- **TwentyFourHours:** Call centre is open all the time on the specified day.
- **OpenPeriod:** Period of opening the specified day; **StartTime** to **EndTime**.
- **Unavailable:** Call centre is not open at all on the specified day.

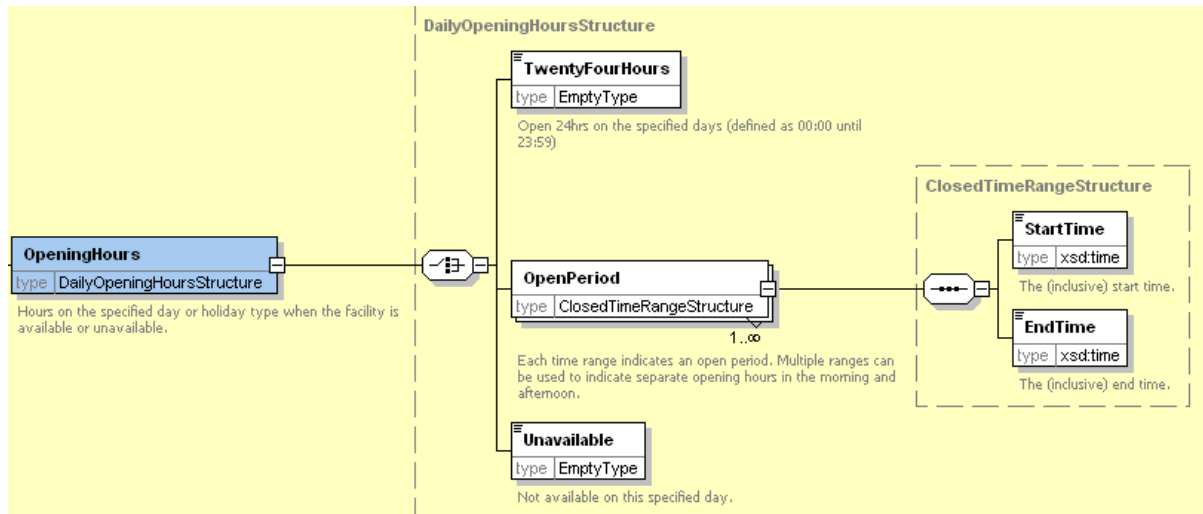

Figure 7-11 – OpeningHours Element

7.5.5 TelephoneContactStructure Element

The **TelephoneContactStructure** element (Figure 7-12) specifies telephone number details. It comprises:

- **TelNationalNumber**: Full telephone number.
- **TelExtensionNumber**: Extension suffix.
- **TelCountryCode**: Two character country prefix.

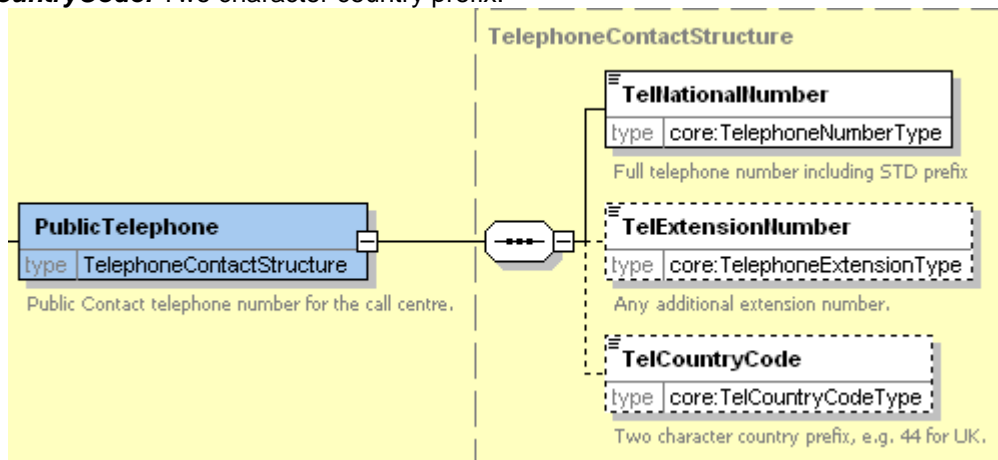

Figure 7-12 – PrimaryTelephoneNumber Element

7.6 TrunkLocality Element

A **TrunkLocality** element (Figure 7-7) represents a geographical grouping of stops relevant for making trunk journeys. It can be used by Journey Planners to find the trunk access points for a place.

- **TrunkLocality Code**: Unique NPTG code for **TrunkLocality**.
- **Name**: Optional name of **TrunkLocality** if different from that of the associated **NptgLocality**.
- **Location**: Location of **TrunkLocality**. Optional geospatial Location of **TrunkLocality** if different from that of the associated **NptgLocality**.
- **NptgLocalityRef**: Reference to an **NptgLocality** instance associated with **TrunkLocality**.
- **NptgStopPointRefs**: References to one or more **StopPoint** instances grouped by the **TrunkLocality**.
 - ❖ **StopPointRef**: Identifier of a **StopPoint** grouped by the **TrunkLocality**.

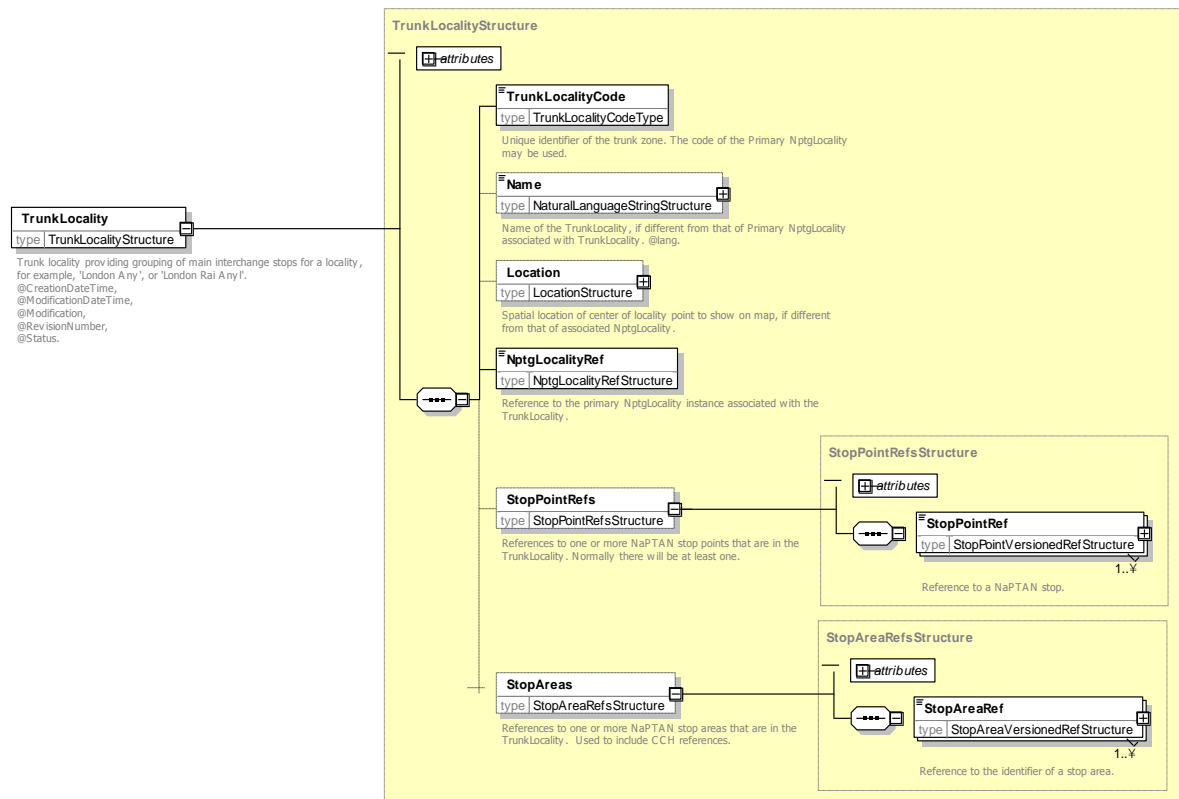

Figure 7-13 – TrunkLocality Element

8 COMMON SCHEMA ELEMENTS

Some elements and types are common to a number of different elements in the *NPTG and NaPTAN* schemas. These are described here.

8.1 Duration Simple Type

The **Duration** simple type is used to specify a relative time in minutes and seconds. It uses a standard W3C type. Times are encoded in the form *PT999M99S*, for example, 'PT12M22S' to denote twelve minutes and twelve seconds. The seconds may be omitted, thus *PT99M*, for example, or *PT5M* or *PT3H12M*.

8.2 Location Element

The **Location** element (*Figure 8-1*) describes the spatial position of a stop. Coordinates may be specified in Grid or WGS84 formats, or both. The primary coordinates used can be indicated by the **LocationSystem** value (*Grid* or *WGS84*) specified on the **NaPTAN** & **NationalPublicTransportGazetteer** document root elements.

Location coordinates must be supplied for all elements in the specified primary coordinates and may optionally be provided in the other system as well. *NaPTAN* data should be submitted in *Grid* format. *NaPTAN* data will normally be distributed in both formats.

If *Grid* coordinates are provided:

- **GridType:** Nominated grid system e.g. UKOS, IrishOS or ITM (Irish Transverse Mercator); UKOS is assumed by default.
- **Easting:** Easting grid coordinates of stop.
- **Northing:** Northing grid coordinates of stop.

If WGS84 coordinates are provided:

- **Latitude:** Latitude of stop in WGS84 coordinates.
- **Longitude:** Longitude of stop in WGS84 coordinates.]

If both Grid and WGS84 coordinates are specified, then an additional **Translation** tag must be specified around both coordinate groups. This is needed to avoid undecidable condition in some strict XML parsers.

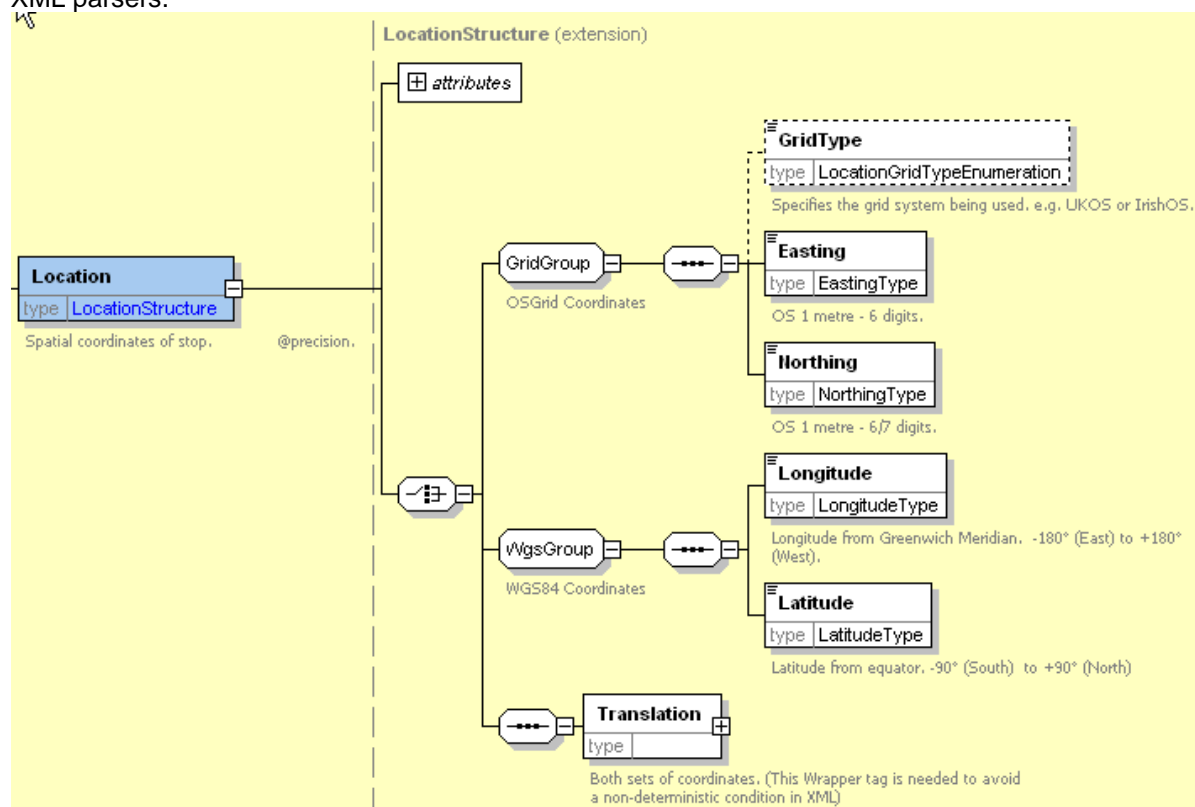

Figure 8-1 – Location Element

8.2.1 Translation Element

The **Translation** element (*Figure 8-1*) describes the spatial position of a stop in multiple coordinate systems. At least one grid system and one set of WGS84 coordinates must be used.

Coordinates are as described above. More than one set of Grid Coordinates (e.g. IrishOs and ITM) may be provided at the same time (+NaPT v2.5)

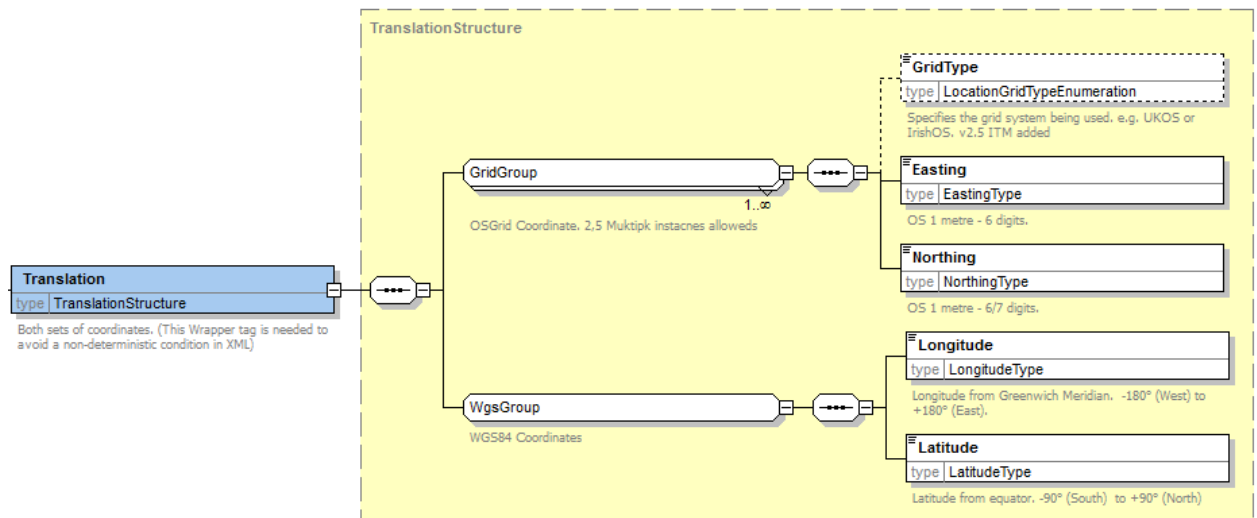

Figure 8-2 – Translation Element

8.3 Bearing Element

The **Bearing** element (*Figure 8-3*) describes a relative direction.

- **CompassPoint:** Compass direction. See *Table 8-1*. Eight point compass bearing (N, S, E, W etc). Suitable for creating a simple text description to passengers.
- **Degrees:** Direction in degrees 0-360. 0 is North. This allows a precise additional bearing to be given for use in some applications. If present, should be consistent with the CompassPoint enumeration which will be an approximation of the exact bearing). Note however that this correspondence is not validated or enforced by the Landmark import processes). Bearing only needs to be populated if the degree values are different from the cardinal point values (i.e. if it is other than 0, 45, 90, 135, 180, 225, 270, 315 degrees),

Value	Description
N	North
NW	North-West
W	West
SW	South-West
S	South
SE	South-East
E	East
NE	North-East

Table 8-1 – Allowed Values for StopPoint / Descriptor /Bearing

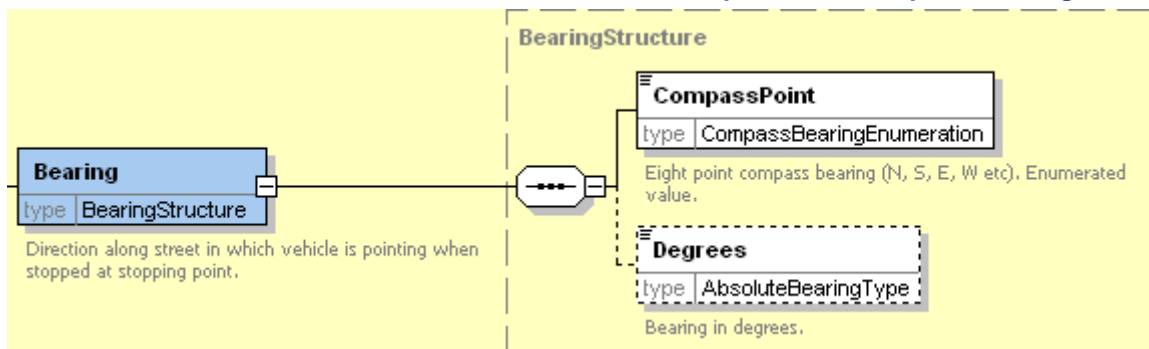

Figure 8-3 – Bearing Element

9 NAPATAN EXAMPLES

The following examples are intended to illustrate the naming and grouping of stops. Examples 1-6 were taken originally from the *NaPTAN* Specification v1.0 but have been updated.

The examples used have been chosen to reflect the common occurrences and naming 'styles' of PTANs:

1. A bus stop on each side of a road, with only one landmark.
2. A bus stop on each side of a road, each with a different landmark.
3. A bus stop on one side of the road, with a recognisable landmark.
4. A bus stop one side of a road, with no landmark.
5. A bus 'Interchange' or on-street group of bus stops.
6. A bus 'Hail & Ride' section or route.
7. A bus 'Flexible' stop zone.
8. A metro station and light rail interchange.
9. A railway station with surrounding stops.
10. A major airport with rail, coach, metro, taxi and bus interchanges.

Each example includes a detailed map and a location map, from which one can judge how important the area served is, and how one has to describe each stop.

Most of the examples include stop areas to group stop points as an interchange comprising several stop points.

Although correct in their application of *NaPTAN* principles, these examples are for illustrative purposes only and not be regarded as the definitive *NaPTAN* stop details for the stops shown.

Note that *AtcoCode* and the NPTG code for an *AdministrativeArea* are different. In the examples generally both are shown together with the text name of the area in the form *AtcoCode (NptgAdminAreaCode) → Name*, for example '199 (44) →Portsmouth'.

9.1 Example 1: Poles Both Sides of the Road with One Landmark

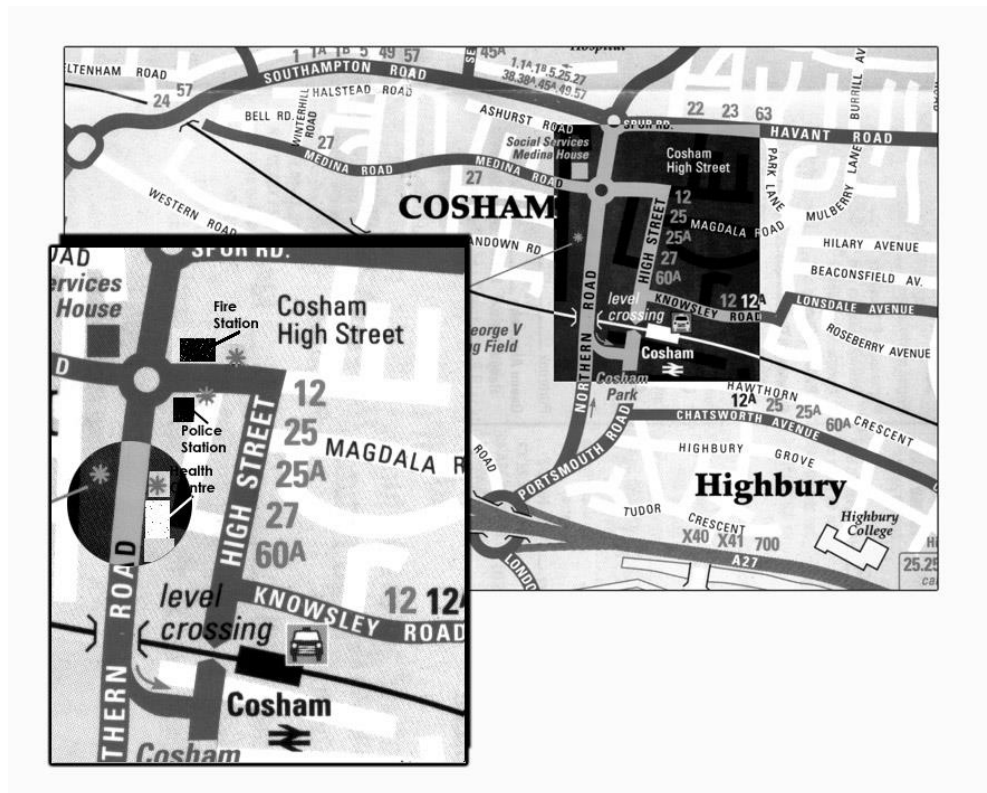

Map taken from City of Portsmouth publication Public Transport Maps

Figure 9-1 – Example 1: Poles Both Sides of the Road with One Landmark

In Figure 9-1, there are two stops, on either side of the road in a small town, 'Cosham', with the 'Health Centre' as the nearest landmark.

- Both stops are named after the Landmark, with different indicators.
- The two stops are linked as a pair with a stop area called 'Health Centre' of type 'GPBS' (Paired On-Street Bus).
- Neither stop is considered to be at the centre of the locality.
- The two stops have been agreed as Principal Timing Points between the local authority and the bus operators.

Figure 9-2 shows the stop hierarchy – with the single stop area and the pair of stops.

Cosham Health Centre Example

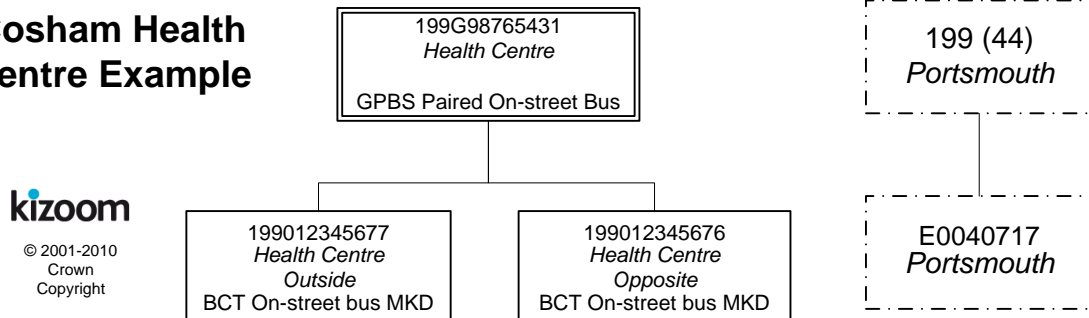

Figure 9-2 – Example 1: Stop Hierarchy for Cosham Health Centre

9.1.1 NaPTAN StopArea Definition: Example 1

Element	Subelement	Stop Area
StopAreaCode		199G98765431
StopArea / Name		Health Centre
StopAreaType		GPBS (Paired on street bus)
Location	Grid Type	UKOS
	Easting	466312
	Northing	105510
ParentAreaRef		--
AdministrativeArea		199 (44) → Portsmouth
Change Attributes	CreationDateTime	2004-04-14T14:20:00-05:00
	ModificationDateTime	2004-04-14T14:20:00-05:00
	Modification	new
	RevisionNumber	0
	Status	Active

9.1.2 NaPTAN StopPoint Definitions: Example 1

Element	Subelement	Stop Points	
		East Side Stop	West Side Stop
AtcoCode		199012345677	199012345676
NaptanCode		porpapa	pormama
Location	GridType	UKOS	UKOS
	Easting	466315	466310
	Northing	105515	105505
Descriptor	CommonName	Health Centre	Health Centre
	Short CommonName	Health Ctr	Health Ctr
	Landmark	Health Centre	Health Centre
	Street	Northern Road	Northern Road
	Crossing	--	--
	Indicator	o/s	opp
Bearing	CompassPoint	S	N
Place	NptgLocalityRef	E0040717 → Cosham [NPTG]	E0040717 → Cosham [NPTG]
	Town	--	--
	Suburb	--	--
	Country	England	England
	LocalityCentre	N	N
StopClassification	StopType	BCT (On-street bus)	BCT (On-street bus)
Bus	BusStopType	MKD (Marked)	MKD (Marked)
	TimingStatus	PTP (Principal Timing point)	PTP (Principal Timing point)
	DefaultWaitTime	0	0
Notes		--	--
*StopAreaRefs	StopAreaRef	199G98765431 → Health Centre	199G98765431 → Health Centre
AdministrativeArea		199 (44) → Portsmouth [NPTG]	199 (44) → Portsmouth [NPTG]

9.1.3 Names in Context

Depending on application and the other data present, the stop names might appear variously in context in a finder as follows:

- → Cosham, Health Centre
- → Cosham, Health Centre (o/s)
- → Cosham, Health Centre (opp)
- → Cosham, Northern Road - Health Centre
- → Cosham, Northern Road - Health Centre (o/s)
- → Cosham, Northern Road - Health Centre (opp)
- → Cosham,, o/s Health Centre, on Northern Road
- → Cosham,, opp Health Centre (on Northern Road)

9.2 Example 2: Poles Both Sides with Different Common Names and Landmarks

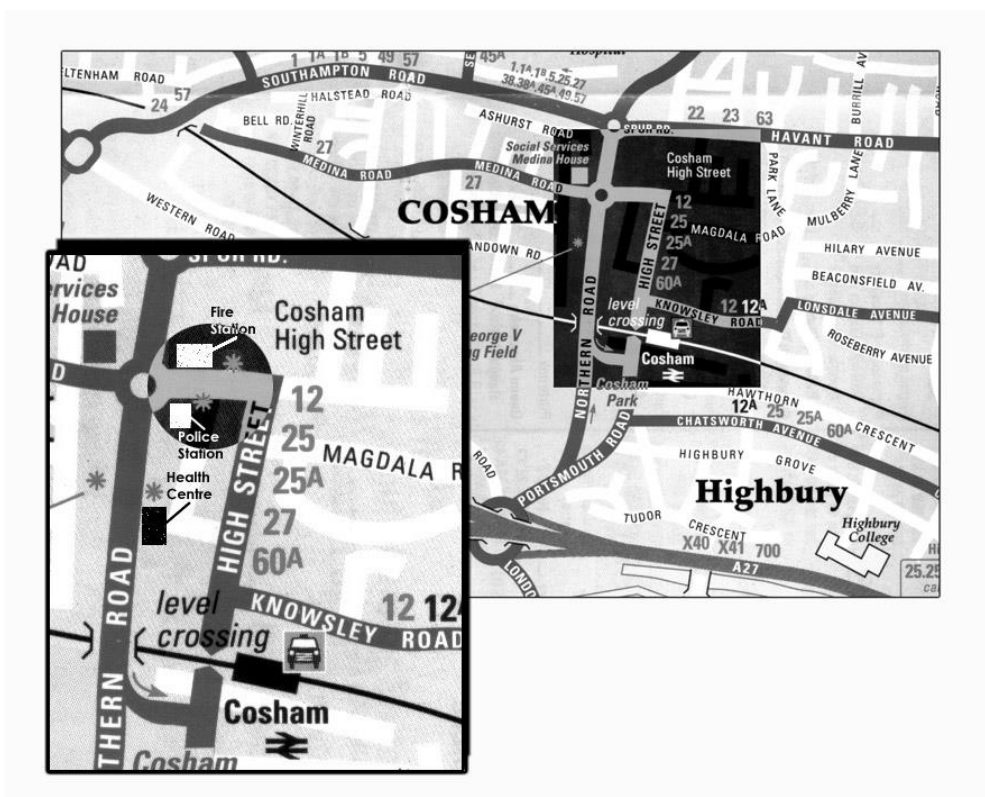

Map taken from City of Portsmouth publication Public Transport Maps

Figure 9-3 – Example 2: Poles Both Sides with Different Common Names

In *Figure 9-3* there are two stops on either side of the road in 'Cosham'; one outside the police station and the other outside the fire station. The names *Police Station* and *Fire Station* are used interchangeably by the public for the location.

- Each stop could be named after the landmark on its respective side of the road, with alternative common names to relate the stop to the other landmark. However, the preferred option is that one of the names is applied to the **StopArea** and as the **CommonName** for both of the stops – and the other of the names is used as an alternative name for all of the records.
- The two stops are grouped as a pair using a stop area of type 'GBPS' (Paired On-Street Bus). One of the Landmarks - '*Fire Station*' – is used as the stop area name.
- The stops are considered to serve the centre of the locality, '*Cosham*'.
- The nearest cross-street is Wootton Street.
- The two stops have been agreed as a Time Info Point between the local authority and the bus operators.

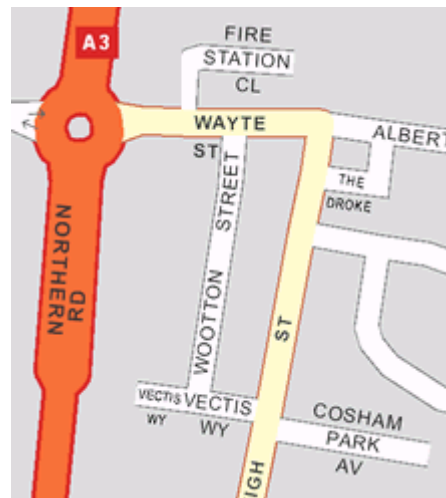

Figure 9-4 – Example 2: Street Names in Central Cosham

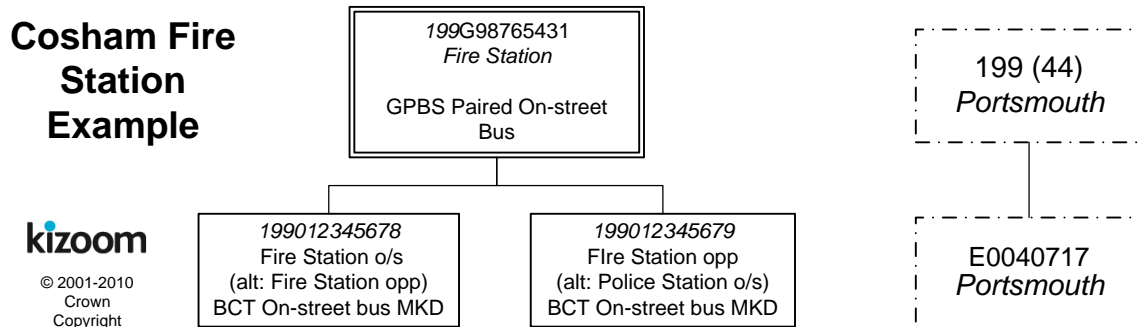

Figure 9-5 – Example 2: Stop Hierarchy for Cosham Fire & Police Stations

9.2.1 NaPTAN StopArea Definitions: Example 2

Element	Subelement	Stop Area
StopAreaCode		199G98765432
StopArea / Name		Fire Station
AlternativeNames	Name	Police Station
StopAreaType		GPBS (Paired on-street bus)
Location	Grid Type	UKOS
	Easting	466370
	Northing	105847
ParentAreaRef		--
AdministrativeArea		199 (44) →Portsmouth [NPTG]

9.2.2 NaPTAN StopPoint Definitions: Example 2

Element	Subelement	Stop Points	
		Eastbound Stop	Westbound Stop
AtcoCode		199012345678	199012345679
NaptanCode		porgaga	porpaw
Descriptor	CommonName	Fire Station	Fire Station
	Landmark	Fire Station	Fire Station
	Street	Wayte Street	Wayte Street
	Crossing	Northern Road	Northern Road
	Indicator	o/s	opp
*AlternativeDescriptor	CommonName	Police Station	Police Station
	Landmark	Police Station	Police Station
	Street	Wayte Street	Wayte Street
	Crossing	Wootton Street	Wootton Street
	Indicator	opp	o/s

Bearing	CompassPoint	<i>E</i>	<i>W</i>
Place	NptgLocalityRef	<i>E0040717→Cosham</i>	<i>E0040717→Cosham</i>
	Town	--	--
	Suburb	--	--
	Country	<i>England</i>	<i>England</i>
	LocalityCentre	<i>Y</i>	<i>Y</i>
Location	GridType	<i>UKOS</i>	<i>UKOS</i>
	Easting	<i>466375</i>	<i>466365</i>
	Northing	<i>105850</i>	<i>105845</i>
StopClassification	StopType	<i>BCT (On-street bus)</i>	<i>BCT (On-street bus)</i>
Bus	BusStopType	<i>MKD (Marked)</i>	<i>MKD (Marked)</i>
	TimingStatus	<i>TIP (Time info point)</i>	<i>TIP (Time info point)</i>
	DefaultWaitTime	<i>0</i>	<i>0</i>
Notes		--	--
*StopAreaRefs	StopAreaRef	<i>199G98765432→ Fire Station</i>	<i>199G98765432→ Fire Station</i>
AdministrativeArea		<i>199 (44)→Portsmouth [NPTG]</i>	<i>199 (44)→Portsmouth [NPTG]</i>

9.2.3 Names in Context

Depending on the application and the other stops data present, the stop names might appear variously in context in a finder as follows:

- → *Cosham, Fire Station (pair)*
- → *Cosham, Fire Station (o/s)*
- → *Cosham, Fire Station (opp)*
- → *Cosham, Police Station (pair)*
- → *Cosham, Police Station (opp)*
- → *Cosham, Police Station (o/s)*
- → *Cosham, WayteStreet - Police Station (opp)*
- → *Cosham, O/s WayteStreet - Police Station (opp)*
- → *Cosham, o/s Fire Station (on Wayte Street) {SMS: porgaga}*

9.3 Example 3: Pole One Side Only with Landmark

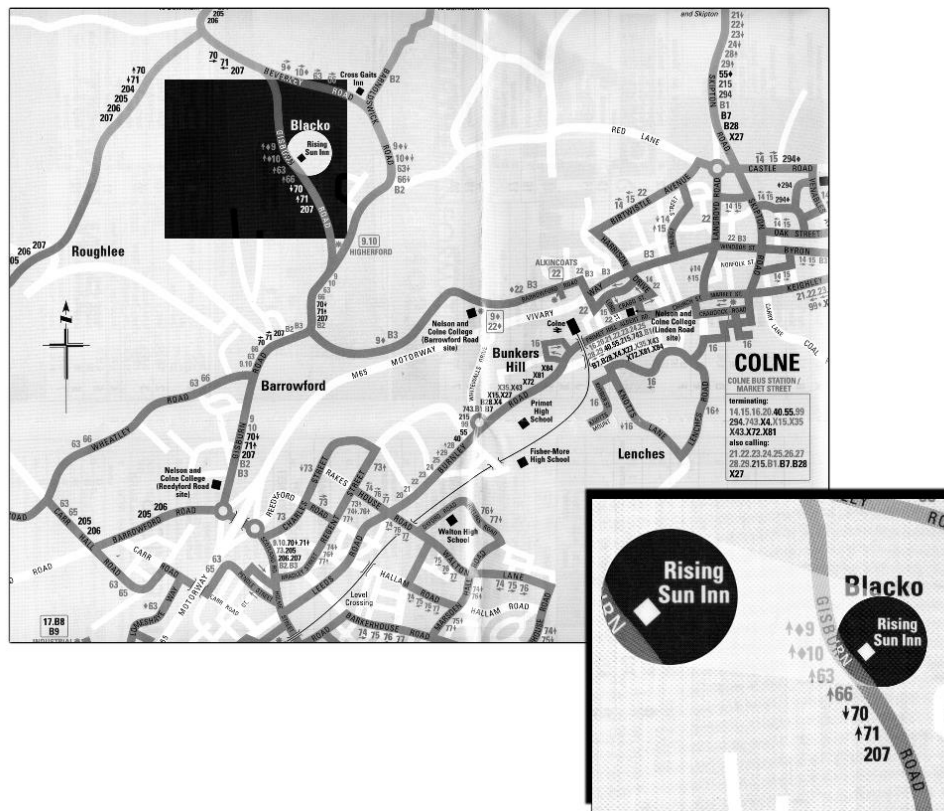

Map taken from Lancashire publication Burnley Bus Map & Guide

Figure 9-6 – Example 3: Pole, One Side Only with Landmark

In Figure 9-6, the stop is a single pole on one side of the road, outside 'The Rising Sun' public house in the village of 'Blacko', which serves for both directions. As can be seen in Figure 9-7, there are no nearby cross streets, so the location can best be described by the pub as a landmark:

- Two stops are defined, even though there is physically only one pole. One is of type BCT-MKD, the other of type BCT-CUS.
- The two stops are linked as a pair by a 'GPBS' stop area.
- The stops are neither principal timing points, nor time info points.



Figure 9-7 – Example 3: Blacko Village map

Blacko Rising Sun Example

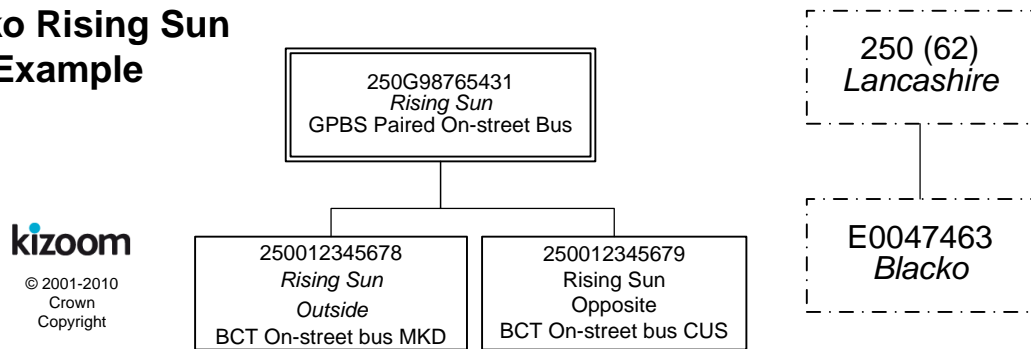

Figure 9-8 – Example 3: Stop Hierarchy for Blacko Rising Sun

9.3.1 NaPTAN StopArea Definitions: Example 3

Element	Subelement	Value
StopAreaCode		250G98765431
StopArea / Name		Rising Sun
StopAreaType		GPBS (Paired on-street bus)
Location	GridType	UKOS
	Easting	387497
	Northing	442100
ParentAreaRef		--
AdministrativeArea		250 (62) → Lancashire [NPTG]

9.3.2 NaPTAN StopPoint Definitions: Example 3

Element	Subelement	Stop Points	
		Marked Side	Unmarked Side
AtcoCode		250012345678	250012345679
NaptanCode		landaga	lanamam
Descriptor	CommonName	Rising Sun	Rising Sun
	Landmark	Rising Sun Inn	Rising Sun Inn

	Street	<i>Gisburn Road</i>	<i>Gisburn Road</i>
	Indicator	<i>o/s</i>	<i>opp</i>
	Bearing	<i>SE</i>	<i>NW</i>
Place	NptgLocalityRef	<i>E0047463→Blacko</i>	<i>E0047463→Blacko</i>
	Town		
	Suburb	<i>--</i>	<i>--</i>
	Country	<i>England</i>	<i>England</i>
	LocalityCentre	<i>N</i>	<i>N</i>
Location	GridType	<i>UKOS</i>	<i>UKOS</i>
	Easting	<i>387500</i>	<i>387495</i>
	Northing	<i>442100</i>	<i>442100</i>
StopClassification	StopType	<i>BCT (On street bus)</i>	<i>BCT (On-street bus)</i>
Bus	BusStopType	<i>MKD (Marked)</i>	<i>CUS (Custom)</i>
	TimingStatus	<i>OTH</i>	<i>OTH</i>
	DefaultWaitTime	<i>0</i>	<i>0</i>
Notes		<i>--</i>	<i>--</i>
*StopAreaRefs	StopAreaRef	<i>250G98765431 → Rising Sun</i>	<i>250G98765431 → Rising Sun</i>
AdministrativeArea		<i>250 (62)→Lancashire [NPTG]</i>	<i>250 (62)→Lancashire [NPTG]</i>

9.3.3 Names in Context

Depending on the application and the other stops data present, the stop names might appear variously in context stop finders as follows:

- →Blacko, *Rising Sun (pair)*.
- →Blacko, *Rising Sun (o/s)*.
- →Blacko, *Rising Sun (opp)*.
- →Blacko, *Gisburn Road - Rising Sun (o/s)*.
- →Blacko, *Gisburn Road - Rising Sun (opp)*.
- →Blacko, *o/s Rising Sun (on Gisburn Road)*

9.4 Example 4: Unmarked Bus Stop on One Side of a Road with No Landmark

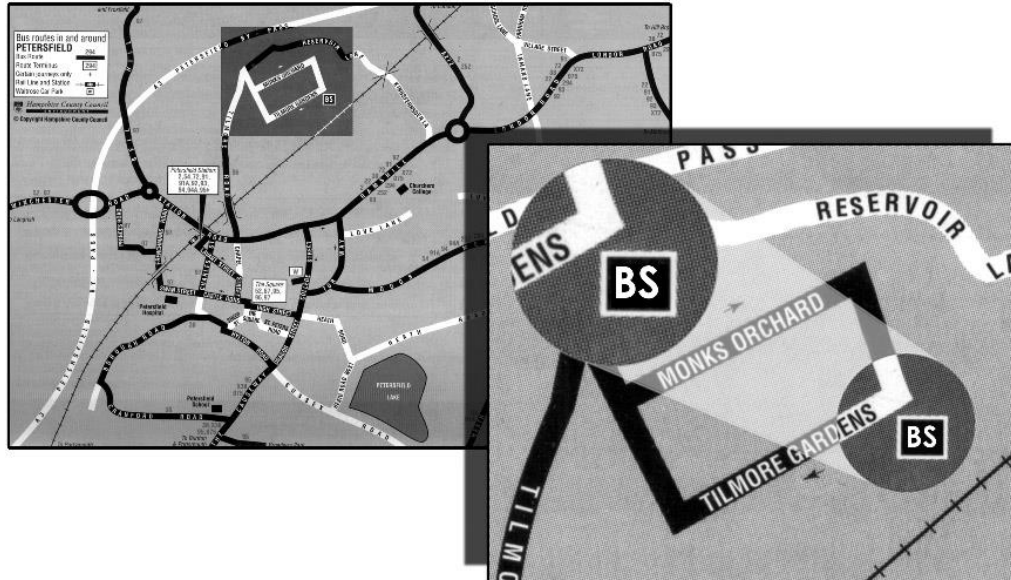

Map taken from Hampshire CC publication Connections – Petersfield

Figure 9-9 – Example 4: Bus Stop on One Side of a Road with No Landmark

In Figure 9-9, 'Tilmore Gardens' is a low frequency stop in a quiet housing estate, with no other stops nearby.

- The stop is named after the street, and is an unmarked stop.
- There are no nearby road junctions or distinguishing landmarks, so the **Landmark** element is left blank.
- 'o/s 57' is used as an **Indicator** value to show where in the street the stop is found.
- This stop does not form part of any stop area.
- The stop is not a principal timing point nor a time info point.
- Between 10/07/2005 and 08/08/2005 the stop will be moved temporarily to another stop in the adjacent *Monks Orchard* street. 'Tilmore Garden' has a **StopAvailability** of *suspended* during this period; both 'Tilmore Gardens' and 'Monks Orchard' have an *active* status.

Tilmore
Example

kizoom

© 2001-2010
Crown
Copyright

190012345671
Tilmore Gardens
BCT On-street bus CUS

190 (52)
Hampshire

E0046774
Petersfield

Figure 9-10 – Example 4: Stop Hierarchy for Tilmore Gardens

9.4.1 NaPTAN StopPoint Definition: Example 4

Element	Subelement	Stop Point		
		Tilmore Gardens	Monks Orchard	
AtcoCode		190012345671	190012345675	
NaptanCode		hamamat		
Descriptor	CommonName	Tilmore Gardens	Monks Orchard	
	Landmark	Tilmore Gardens	Tilmore Gardens	
	Street	Tilmore Gardens	Monks Orchard	
	Indicator	o/s 57	o/s 22	
Bearing	CompassPoint	SW	SE	
Place	NptgLocalityRef	E0046774→Petersfield	E0046774→Petersfield	
	Town	--	--	
	Suburb	--	--	
	Country	England	England	
	LocalityCentre	N	N	
Location	GridType	UKOS	UKOS	
	Easting	474506	474306	
	Northing	124867	124997	
StopClassification	StopType	BCT (On-street bus)	BCT (On-street bus)	
Bus	BusStopType	CUS (Custom)	CUS (Custom)	
	TimingStatus	OTH	OTH	
	WaitTime	0	0	
Notes		--	--	
*StopAreaRefs	StopAreaRef	--	--	
AdministrativeArea		190→(52)→Hampshire [NPTG]	190→(52)→Hampshire [NPTG]	
StopAvailability	StopValidity	DateRange / StartDate	10/07/2005	10/07/2005
		DateRange / EndDate	08/08/2005	08/08/2005
		Status	Suspended	Active
		Transferred	190012345675	

9.4.2 Names in Context

Depending on the application and the other stops data present, the stop name might appear variously in context in a finder as follows:

- → Petersfield, Tilmore Gardens (o/s 57)
- → Petersfield. o/s 57 Tilmore Gardens (on Tilmore Gardens)

9.5 Example 5: Bus Interchange

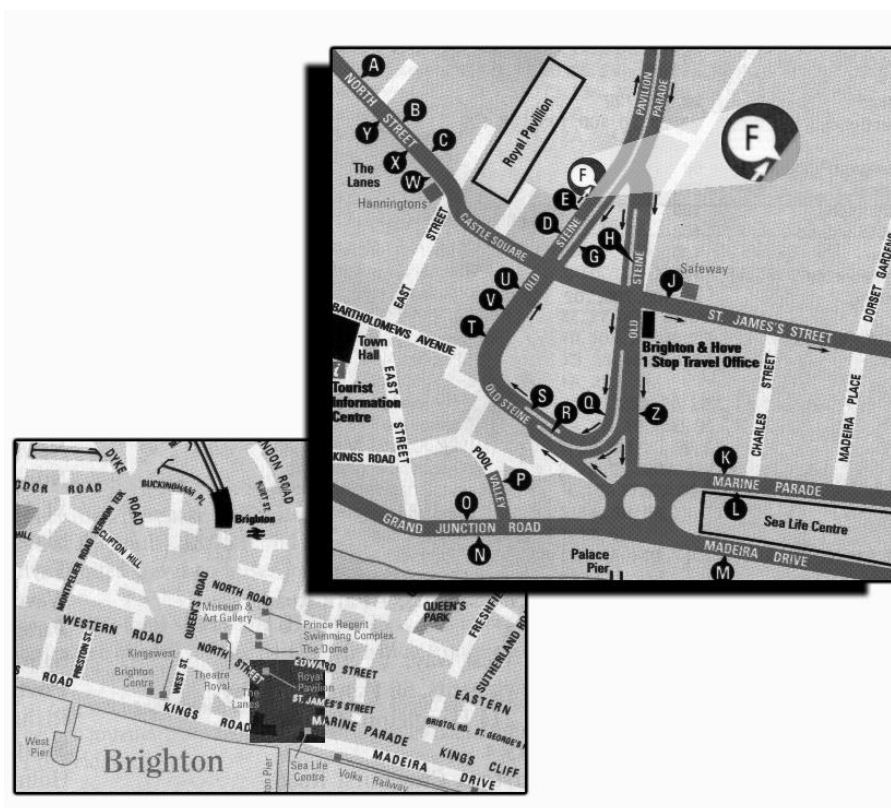

Map taken from Brighton & Hove Bus Company publication Bus Times

Figure 9-11 – Example 5: Bus Interchange

In Figure 9-11, based on the Royal Pavilion area of Brighton Town Centre, stops 'D', 'E' and 'F' comprise an on-street clustered 'GCLS' stop area with individually identified poles. Depending on the pattern of bus turning movements at the junction of 'Old Steine' and 'Castle Square', stops 'T', 'U' and 'V' and even 'G', 'H', & 'J' could also be included in the stop area. Similarly, other stop areas could be used to group other stop clusters such as 'A', 'B', 'C', 'Y', 'X', 'W'. A single stop area probably should not be used, as the stops at the extremities (e.g. A and M) are more than 250m apart, and do not constitute an obvious interchange: the general association of all the stops with a common NPTG locality of Brighton Town Centre may suffice to indicate a degree of relatedness. Alternatively a further stop area containing this and other adjacent stop areas may be required.

- A stop area is defined for the interchange, and the three stops are assigned to it.
- The stops are all Principal Timing Points.

Figure 9-12 shows a stop hierarchy – with a stop area and three stops.

Brighton Example

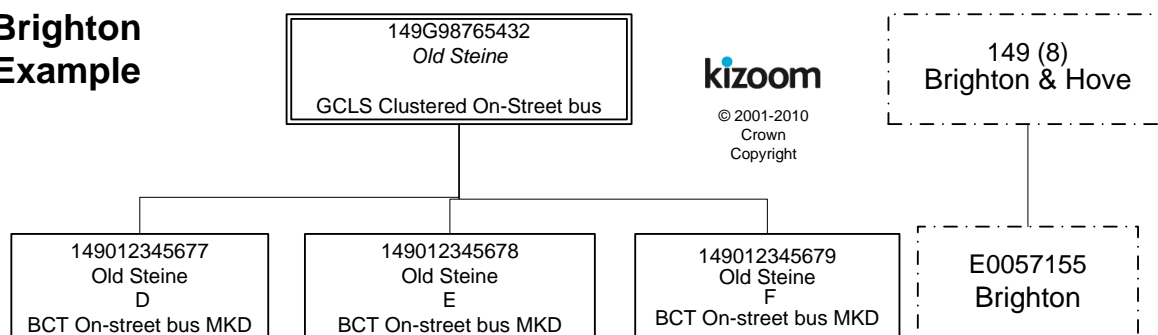

Figure 9-12 – Example 5: Stop Hierarchy for Brighton Old Steine

9.5.1 NaPTAN StopArea Definition: Example 5

Element	Subelement	Stop Area
StopAreaCode		149G98765432
StopArea / Name		Old Steine
StopAreaType		GCLS (Clustered on-street bus)
Location	GridType	UKOS
	Easting	531210
	Northing	105485
ParentAreaRef		--
AdministrativeArea		149 (8) → Brighton & Hove [NPTG]

9.5.2 NaPTAN StopPoint Definitions: Example 5

Element	Subelement	Stop Points		
		Stop D	Stop E	Stop F
AtcoCode		149012345677	149012345678	149012345679
NaptanCode		briwaga	briwagd	briwagg
Descriptor	CommonName	Old Steine	Old Steine	Old Steine
	Landmark	Royal Pavilion	Royal Pavilion	Royal Pavilion
	Street	Old Steine	Old Steine	Old Steine
	Indicator	Stop D	Stop E	Stop G
Bearing	CompassPoint	NE	NE	NE
Place	NptgLocalityRef	E0057155 → Brighton	E0057155 → Brighton	E0057155 → Brighton
	Town	--	--	--
	Suburb	--	--	--
	Country	England	England	England
Location	LocalityCentre	Y	Y	Y
	GridType	UKOS	UKOS	UKOS
	Easting	531205	531210	531215
	Northing	105475	105485	105495
StopClassification	StopType	BCT (On-street bus)	BCT (On-street bus)	BCT (On-street bus)
Bus	BusStopType	MKD (Marked)	MKD (Marked)	MKD (Marked)
	TimingStatus	PTP (Principal Timing Point)	PTP (Principal Timing Point)	PTP (Principal Timing Point)
	DefaultWaitTime	0	0	0
Notes		--	--	--
*StopAreaRefs	StopAreaRef	149G98765432 → Old Steine	149G98765432 → Old Steine	149G98765432 → Old Steine
AdministrativeArea		149 (8) → Brighton & Hove [NPTG]	149 (8) → Brighton & Hove [NPTG]	149 (8) → Brighton & Hove [NPTG]

9.5.3 Names in Context

Depending on the application and the other stops data present, the stop names might appear variously in context in a finder as follows:

- → Brighton, Old Steine, Stop D
- → Brighton, Old Steine, Stop E
- → Brighton, Old Steine, Stop F

9.6 Example 6: Hail & Ride Stop Sections

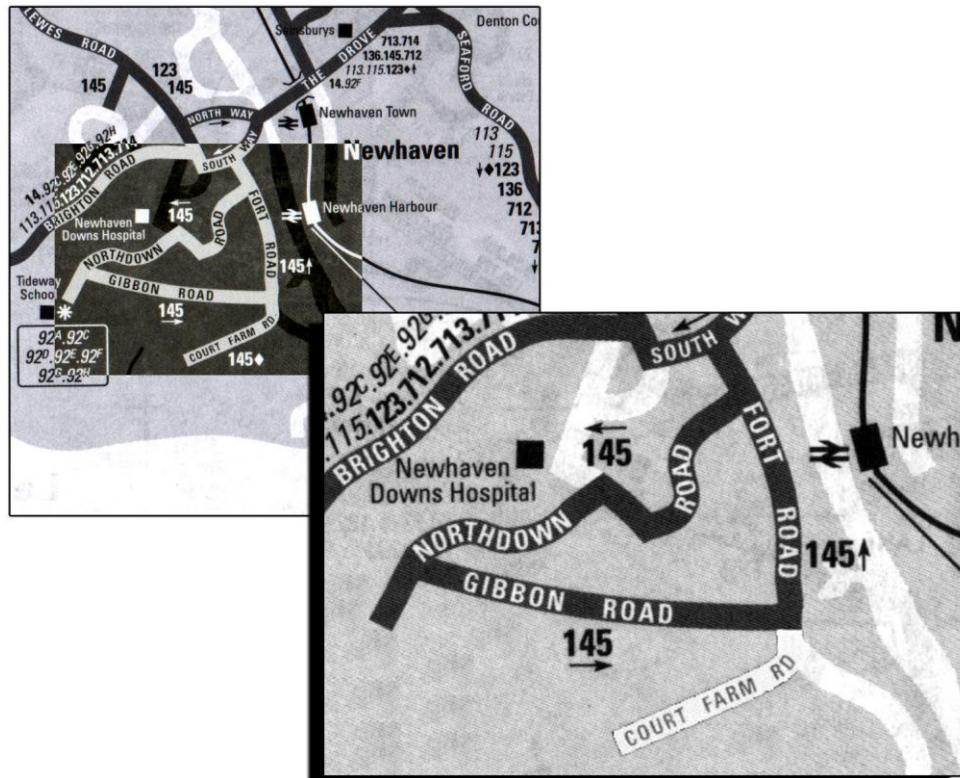

Map taken from East Sussex publication Bus Timetables

Figure 9-13 – Example 6: Hail & Ride

To name the zones covered by Hail & Ride services, a NaPTAN stop point entry is required for each road on the Hail & Ride section. In the example in Figure 9-13, Hail & Ride sections are defined for 'Northdown Road', and 'Fort Road', with a time info point bus stop on Gibbon Road.

- Each Hail & Ride entry corresponds to a section of the Hail & Ride route, so there are two Hail & Ride entries with a **StopClassification** of **HailAndRide (HAR)**.
- Each Hail & Ride stop point has **HailAndRide / Start** and **End** elements.
- Hail & Ride and regular bus stop entries can be mixed; there is also one regular bus stop entry.
- *Gibbon Road* is a time info point.

Note that if the 'Gibbon Road' had been a Hail & Ride road as well, it would be represented by two Hail & Ride sections, one each side of the marked stop in 'Gibbon Road.'

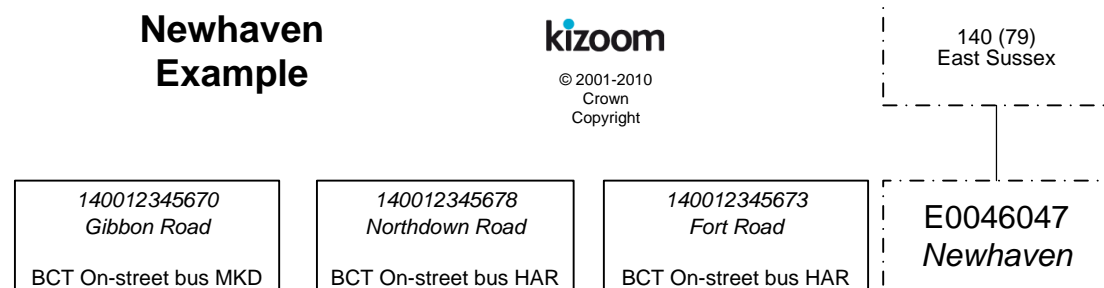

Figure 9-14 – Example 6: Stop Hierarchy for Newhaven Hail & Ride

9.6.1 NaPTAN StopPoint Definition: Example 6

Element	Subelement	Stop Points		
		<i>Gibbon Road Stop</i>	<i>Northdown Road</i>	<i>Fort Road</i>
AtcoCode		140012345670	140012345678	140012345673
NaptanCode		brimgdt	brimgpdt	brigaga
Descriptor	CommonName	Gibbon Road	Northdown Road	Fort Road
	Landmark	Gibbon Road	Newhaven Downs Hospital	Station
	Street	Gibbon Road	Northdown Road	Fort Road
	Indicator	E-bound	W-bound	N-bound
	NamingStyle	Street	Street	Street
Bearing	CompassPoint	E	SW	N
Place	NptgLocalityRef	E0046047 →Newhaven	E0046047 →Newhaven	E0046047 →Newhaven
	Town	--	--	--
	Suburb	--	--	--
	Country	England	England	England
	LocalityCentre	N	N	N
Location	GridType	UKOS	UKOS	UKOS
	Easting	543975	543915	544528
	Northing	100555	100785	100858
StopClassification	StopType	BCT (On-street bus)	BCT (On-street bus)	BCT (On-street bus)
OnStreet / Bus	BusStopType	MKD (Marked)	HAR (Hail & Ride)	HAR (Hail & Ride)
	TimingStatus	TIP (Timing Info Point)	OTH	OTH
	DefaultWaitTime	0	0	0
HailAndRide / Start	GridType		UKOS	UKOS
	Easting		544300	544536
	Northing		101000	100516
HailAndRide / End	Grid Type		UKOS	UKOS
	Easting		543531	544520
	Northing		100571	101200
Notes		--	--	--
*StopAreaRefs	StopAreaRef	--	--	--
AdministrativeArea		140 (79) →East Sussex	140 (79) →East Sussex	140 (79) →East Sussex

9.6.2 Names in Context

Depending on the application and the other stops data present, the stop names might appear variously in context in a finder as follows (where Hail-and-Ride is added by the output system because the stop concerned is of stop type HAR):

- → Newhaven, Gibbon Road, E-bound
- → Newhaven, Northdown Road (Hail-and-Ride), W-bound
- → Newhaven, Fort Road (Hail-and-Ride), N-bound

9.7 Example 7: Flexible Service Stop Zones

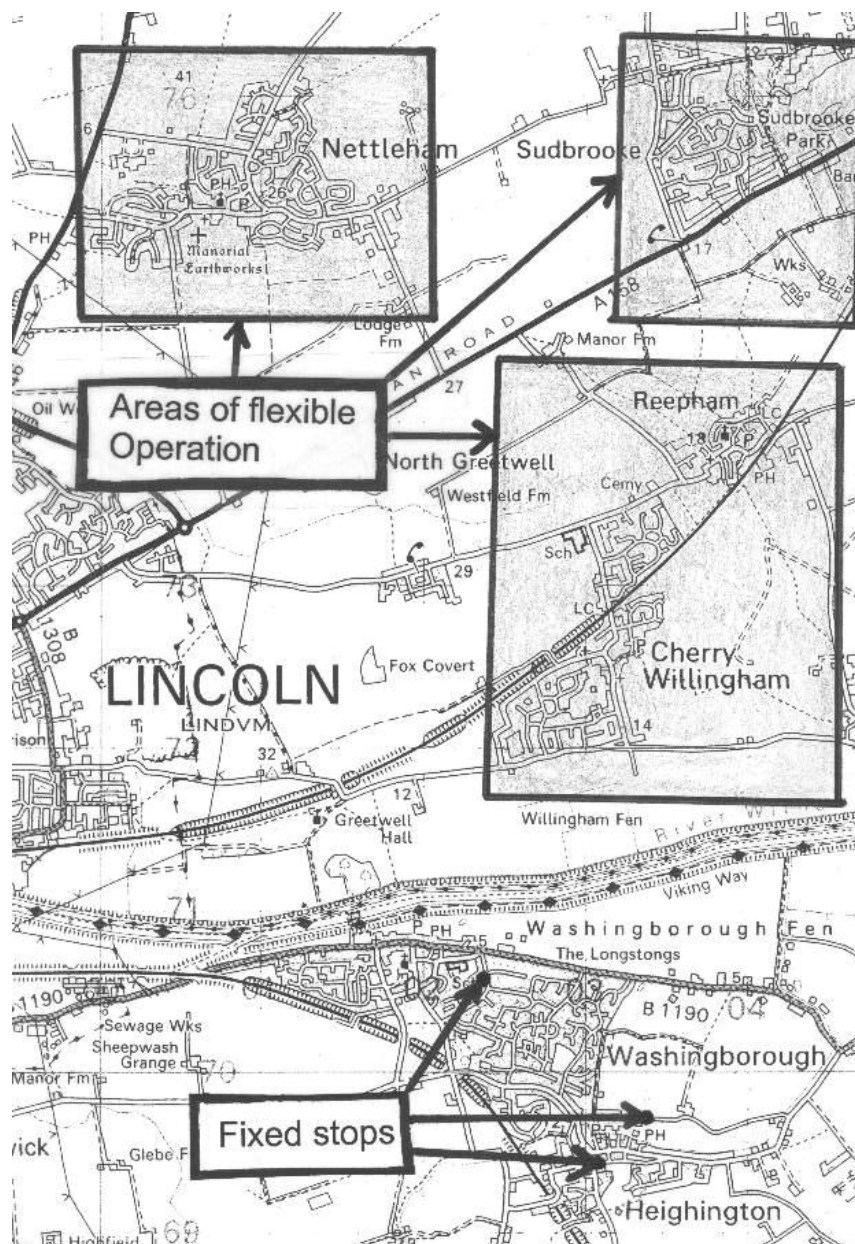

Figure 9-15 – Example 7: Flexible Zones

Flexible services may have two types of stops: *flexible zones* and *fixed stops*. To name the zones covered by flexible services, a *NaPTAN* stop point is required for each flexible zone. In the example there are three flexible zones shown. The location attribute corresponds to the centre of the zone:

- Flexible zone stops ('FLX') are defined for 'Nettleham', 'Sudbrooke' and 'Cherry Willingham',
 - The 'Cherry Willingham' area falls into two different *NPTG* localities so the stop is assigned to the main zone, 'Cherry Willingham', but has the other zone 'Reepham' specified as an alternative *NPTG* locality, so that it will also be in the gazetteer as an available transport service for the Reepham area.
 - For each zone, a bounding polygon is defined. This does not necessarily have to be rectangular – normally it will not be!
- In addition, three fixed stops are defined in 'Washingborough' and 'Heighington'.

- No stop areas are needed.
- **NaptanCode** instances have not yet been allocated to the zones.

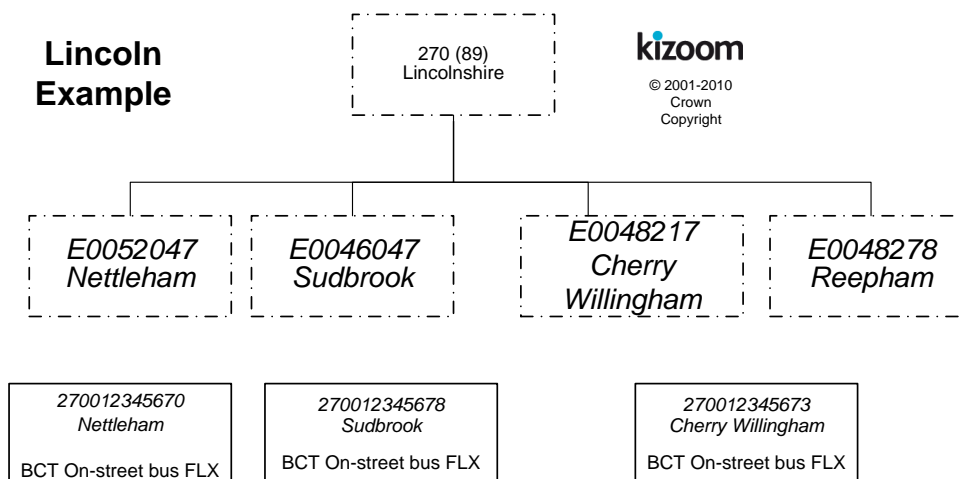

Figure 9-16 – Example 5: Stop Hierarchy for Lincoln Flexible Service

9.7.1 NaPTAN StopPoint Definitions: Example 7

Element	Subelement	Stop Points		
		Nettleham	Sudbrooke	Cherry Willingham
AtcoCode		270023345670	270065345678	27006345673
NaptanCode		--	--	--
Descriptor	CommonName	Nettleham	Sudbrook	Cherry Willingham
	Landmark	Nettleham	Sudbrook	Cherry Willingham
	Street	--	--	--
	Indicator			
Bearing	CompassPoint	-	-	-
Place	NptgLocalityRef	E0052047 → Nettleham	E0046047 → Sudbrooke	E0048217 → Cherry Willingham
	AlternativeNptgLocality			E0048278 → Reepham
	Town	--	--	--
	Suburb	--	--	--
	Country	England	England	England
	LocalityCentre	Y	Y	Y
Location	GridType	UKOS	UKOS	UKOS
	Easting	543975	543915	544528
	Northing	100795	100785	100858
StopClassification	Stop Type	BCT (On-street bus)	BCT (On-street bus)	BCT (On-street bus)
Bus	BusStopType	FLX (Flexible)	FLX (Flexible)	FLX (Flexible)
	TimingStatus	OTH	OTH	OTH
	DefaultWaitTime	0	0	0
*FlexibleZone (multiple records to define polygon)	*GridType	UKOS	UKOS	UKOS
	*Easting	543975.	543915.	544528.
	*Northing	100795.	100785.	100858.
Notes		--	--	--
*StopAreaRefs	StopAreaRef	--	--	--
AdministrativeArea		270 (89) →Lincolnshire NPTG	270 (89) →Lincolnshire NPTG	270 (89) →Lincolnshire NPTG

9.7.2 Names in Context

Depending on the application and the other stops data present, the stop names might appear variously in context in a finder as follows. The phrase (flexible zone) would be added by an output system based on the fact that the stop type is FLX:

- → Nettleham, Nettleham (flexible zone)
- → Sudbrook, Sudbrook (flexible zone).

- → *Cherry Willingham, Cherry Willingham (flexible zone)*
- → *Reepham, Cherry Willingham (flexible zone)*

9.8 Example 8: Railway Station with Bus and Taxi

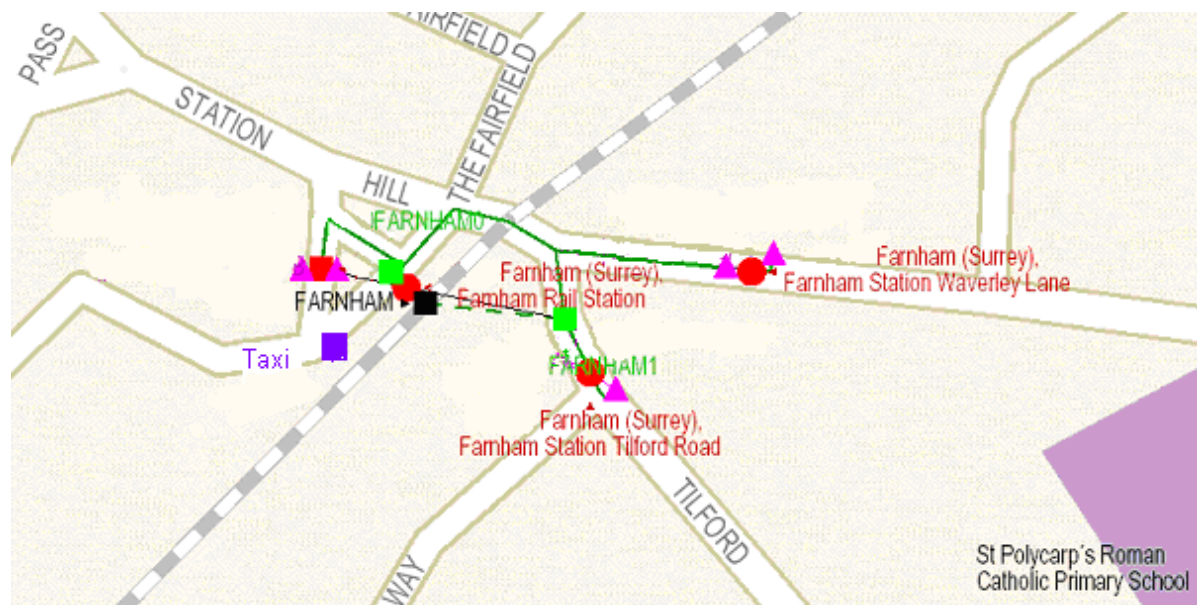

Map courtesy of Dr Hans Mentz, MDV from SELTA region data

Figure 9-17 – Example 8: Railway Station Interchange.

Railway stations are usually not only stop points in their own right, but also important interchange points. In NaPTAN a station always consists of at least of two points; a track area, and a main entrance, and very often includes also one or more adjacent bus stops and a taxi rank. *Figure 9-17* shows an example for 'Farnham Station'; there are three pairs of bus stops in the vicinity which can usefully be associated with the station. Note that the Stop Area for the station Group is created centrally as part of the 910 data set, and so has a different AtcoAreaCode to the other groups.

- Rail - 'GRLS'
 - Farnham Rail Station – Access Area 'RLY'
 - Farnham Rail Station – Main Entrance on Station Approach 'RSE'.
 - Farnham Rail Station – Tilford Road Entrance 'RSE'.
- Bus
 - 'Station Approach' Pair - 'GPBS'
 - Station Approach East
 - Station Approach West
 - 'Waverley Lane' Pair - 'GPBS'
 - Waverley Lane, E-bound.
 - Waverley Lane, W-bound
 - 'Tilford Road' Pair - 'GPBS'
 - Tilford Road, S-bound
 - Tilford Road, N-bound
- Taxi
 - Farnham Rail Station – Taxi Rank 'TXR'

Figure 9-18 shows a possible hierarchy - a stop area is used for each group of stops, and a Rail Station stop area (GRLS) clusters the whole ensemble.

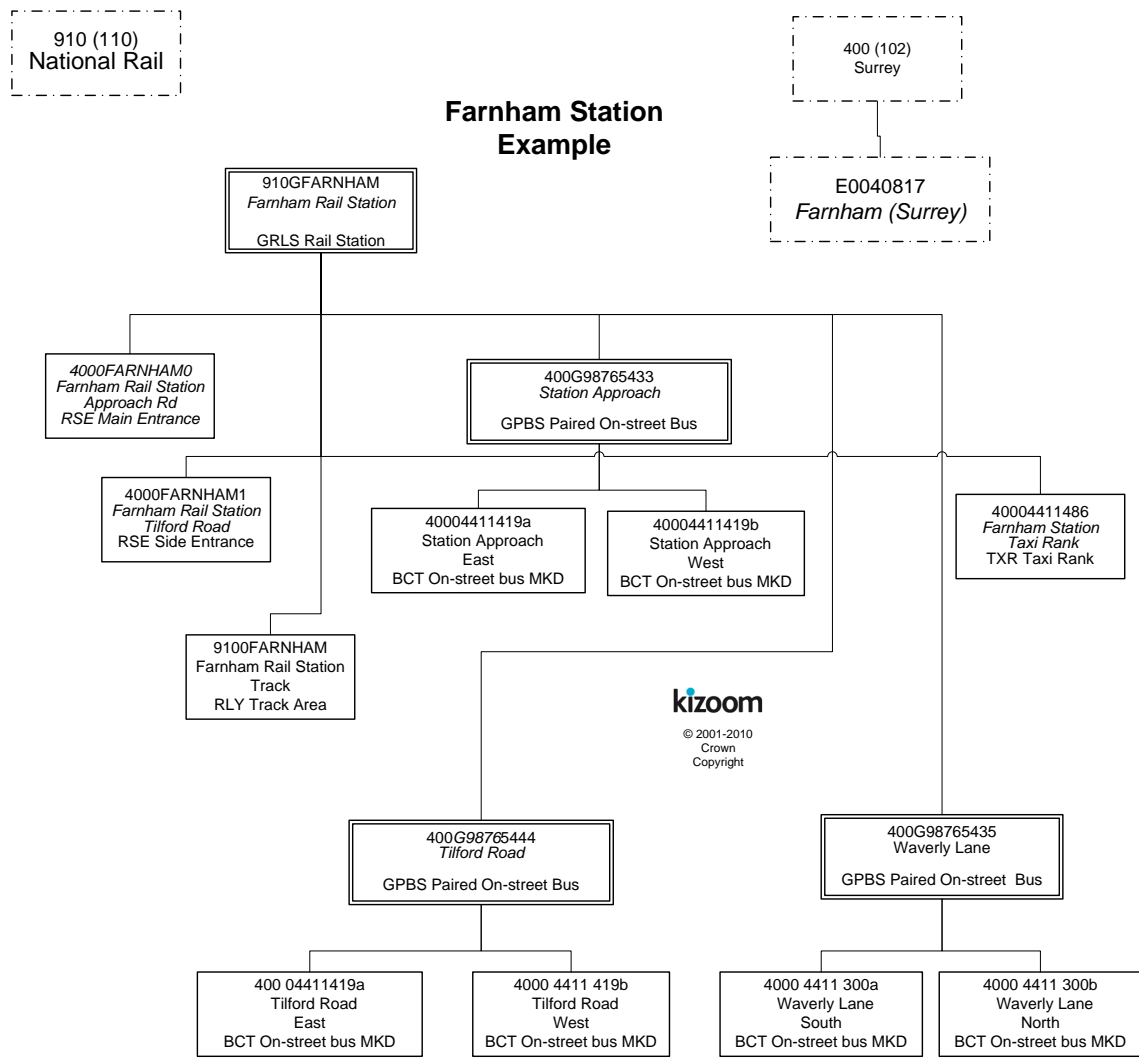

Figure 9-18 – Example 9: Stop Hierarchy for Farnham Station

NOTE: the 9100FARNHAM RLY element is the Access Area – the logical location for a passenger using the station. If the station is a major interchange, this would be where interchange takes place. If the station is mainly used for boarding and alighting, the main booking hall or its equivalent, inside the station entrance, would be appropriate. Note the GRLS and the RLY elements have national prefixes (910) and are managed nationally; all other elements have local prefixes (400 in this case) and are managed locally.

9.8.1 NaPTAN StopArea Definitions: Example 8

Element	Subelement	Stop Areas			
		Rail	Bus Pair 1	Bus Pair 2	Bus Pair 3
StopAreaCode		910GFARNHAM	400G98765433	400G9876544	400G98765435
StopArea / Name		Farnham Rail Station	Station Approach	Tilford Road	Waverley Lane
StopArea Classification		GRLS Rail Station	GPBS On-street bus	GPBS On-street bus	GPBS On-street bus
Location	Grid Type	UKOS	UKOS	UKOS	UKOS
	Easting	466312	466312	466412	466512
	Northing	105510	105511	105519	105510
ParentAreaRef		--	400GFARNHAM	400GFARNHAM	400GFARNHAM
Administrative Area		910 (NR) →National Rail	400 (102) →Surrey	400 (102) →Surrey	400 (102) →Surrey

9.8.2 NaPTAN StopPoint Definitions: Example 8

9.8.2.1 Rail Station Stop Points

Element	Subelement	Stop Points				
		Main Entrance	Side Entrance	AccessArea	Platform 1	Platform 2
AtcoCode		4000FARNHAM0	4000FARNHAM1	9100FARNHAM	9100-FARNHAM1	9100-FARNHAM2
NaptanCode						
Descriptor	CommonName	Farnham Rail Station	Farnham Rail Station	Farnham Rail Station	Platform 1	Platform 2
	Landmark	Station	Station	Station	Station	Station
	Street	Station Approach	Tilford Road	Station Approach		
	Indicator	Main Entrance	Side Entrance		1	2
Bearing	CompassPoint	--	--	--		
Place	NptgLocalityRef	E0040817→ Farnham (Surrey)	E0040817→ Farnham (Surrey)	E0040817→ Farnham (Surrey)	E0040817→ Farnham (Surrey)	E0040817→ Farnham (Surrey)
	Town	--	--	--		
	Suburb	--	--	--		
	LocalityCentre	Y	Y	Y	Y	Y
Location	GridType	UKOS	UKOS	UKOS	UKOS	UKOS
	Easting	466315	466316	466310	466315	466316
	Northing	105515	105518	105505	105515	105518
Stop-Classification	StopType	RSE	RSE	RLY	RSE	RSE
Bus	BusStopType	--	--	--	--	--
	TimingStatus	--	--	--	--	--
	DefaultWaitTime	--	--	--	--	--
Notes		--	--	--	--	
*StopArea-Refs	StopAreaRef	400GFARNHAM → Farnham Rail Station	400GFARNHAM → Farnham Rail Station	400GFARNHAM → Farnham Rail Station	400GFARNHAM → Farnham Rail Station	400GFARNHAM M → Farnham Rail Station
Administrative Area		400 (102)→Surrey	400 (102)→Surrey	910 (NR) →National Rail	910 (NR) →National Rail	910 (NR) →National Rail

9.8.2.2 Bus Stop Points- #1

Element	Subelement	Stop Points			
		Tilford Road a	Tilford Road b	Waverley Lane a	Waverley Lane b
AtcoCode		40004411419a	40004411419b	40004411300a	40004411300b
NaptanCode		surpadgm	surpjadw	surpwdgm	surpjwdw
Descriptor	CommonName	Tilford Road	Tilford Road	Waverley Lane	Waverley Lane
	Landmark	Station	Station	Station	Station
	Street	Tilford Road	Tilford Road	Station Hill	Station Hill
	Indicator	N-bound	S-bound	E-bound	W-bound
Bearing	CompassPoint	NW	SE	E	W

Place	NptgLocalityRef	E0040817→ Farnham (Surrey)	E0040817→ Farnham (Surrey)	E0040817→ Farnham (Surrey)	E0040817→ Farnham (Surrey)
	Town	Farnham	Farnham	Farnham	Farnham
	Suburb	--	--	--	--
	LocalityCentre	N	N	N	N
Location	GridType	UKOS	UKOS	UKOS	UKOS
	Easting	466315	466310	466315	466310
	Northing	105515	105505	105615	105605
StopClassification	StopType	BCT (On-street bus)	BCT (On-street bus)	BCT (On-street bus)	BCT (On-street bus)
Bus	BusStopType	MKD (Marked)	MKD (Marked)	MKD (Marked)	MKD (Marked)
	TimingStatus	TIP (Time info point)	TIP (Time info point)	TIP (Time info point)	TIP (Time info point)
	DefaultWaitTime	0	0	0	0
Notes		--	--	--	--
*StopAreaRefs	StopAreaRef	400G98765432→	400G98765432→	400G98765432→	400G98765432→
AdministrativeArea		400 (102)→Surrey	400 (102)→Surrey	400 (102)→Surrey	400 (102)→Surrey

9.8.2.3 Bus Stop Points- #2

		Stop Points	
Element	Subelement	Station Approach a	Station Approach b
AtcoCode		40004411338a	40004411338b
NaptanCode		surpadgm	surpjadw
Location	GridType	UKOS	UKOS
	Easting	466315	466310
	Northing	105515	105505
Descriptor	CommonName	Station Approach East	Station Approach West
	Landmark	Station	Station
	Street	Station Approach	Station Approach
	Indicator	on	on
Bearing	CompassPoint	S	N
Place	NptgLocalityRef	E0040817→ Farnham (Surrey)	E0040817→ Farnham (Surrey)
	Street	Station Approach	Station Approach
	Town	Farnham	Farnham
	Suburb	--	--
	LocalityCentre	N	N
StopClassification		BCT (On-street bus)	BCT (On-street bus)
BusStop	BusStopType	MKD (Marked)	MKD (Marked)
	TimingStatus	TIP (Time info point)	TIP (Time info point)
	DefaultWaitTime	0	0
Notes		--	--
*StopAreaRefs	StopAreaRef	400G98765433→	400G98765433→
AdministrativeArea		400 (102)→Surrey	400 (102)→Surrey

9.8.3 Names in Context

Depending on the application and the other stops data present, the stop names might appear variously in context in a finder as follows

- → 'Farnham, Farnham Rail Station
- → 'Farnham, Farnham Rail Station, Tilford Road
- → 'Farnham, on Station Approach East
- → 'Farnham, on Station Approach West
- → 'Farnham, Waverley Lane, E-bound
- → 'Farnham, Waverley Lane W-bound
- → 'Farnham, Tilford Road, S-bound
- → 'Farnham, Tilford Road, N-bound

9.8.4 Simple Accessibility

9.8.4.1 Rail Station Stop Points Accessibility (+Napt V2.5)

Stop data may also include Accessibility data. The following map of Farnham Station (courtesy National Rail Enquiries) shows that Farnham Station has two platforms, both of which may be reached by wheelchair and without steps. However not all areas of the station are accessible.

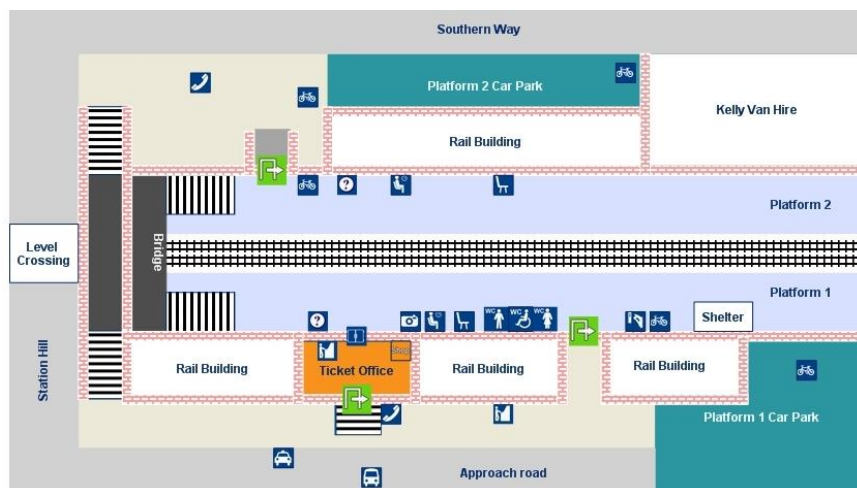

Figure 19 Farnham Rail Example (Copyright National Rail Enquiries)

The following table shows an encoding of some accessibility data for the station stop points.

Element	Subelement	Stop Points				
		Main Entrance	Side Entrance	AccessArea	Platform 1	Platform 2
AtcoCode		4000 FARNHAM0	4000 FARNHAM1	9100 FARNHAM	9100- FARNHAM1	9100- FARNHAM2
Descriptor	CommonName	Farnham Rail Station	Farnham Rail Station	Farnham Rail Station	Platform 1	Platform 2
Stop-Accessibility	MobilityImpaired-Access	true	true	true	true	true
	WheelchairAccess	true	true	partial	true	true
	StepFreeAccess	true	true	partial	true	true
	AudibleSignsAvailable	--	--	true	true	true
	VisualSignsAvailable	--	--	true	true	true
	AssistanceAvailability	available	available	available	available	available
	InfoUrl			http://www.nationalrail.co.uk/stations/FNH/details.html		
	Note			Both platforms have level access. Step free interchange is via a level crossing at the London end of the platforms		
	AccessVehicleEquipment / Ramp				true	true
	AssistanceNeeded			r	ramp-Required	ramp-Required
GuideDogsAllowed			true	true	true	
ServicesAtStopAre-NormallyAccessible			true	true	true	

The following table shows an encoding of basic accessibility data for the bus stop points.

		Stop Points			
Element	Subelement	Tilford Road a	Tilford Road b	Waverley Lane a	Waverley Lane b
AtcoCode		40004411419a	40004411419b	40004411300a	40004411300b
		surpadgm	surpjadw	surpwdgm	surpjwdw
Descriptor	CommonName	Tilford Road	Tilford Road	Waverley Lane	Waverley Lane
Stop-Accessibility	MobilityImpaired-Access	true	true	true	true
	WheelchairAccess	true	true	true	true
	StepFreeAccess	true	true	true	true
	AudibleSignsAvailable	false	false	false	false
	VisualSignsAvailable	true	true	true	true
	AssistanceAvailability	available	available	available	available
	Note	.		Both platforms have level access. Step free interchange is via a level crossing at the London end of the platforms	
	AccessVehicleEquipment / LowFloor	true	true	true	true
	AssistanceNeeded	unknown	unknown	unknown	unknown
	GuideDogsAllowed	true	true	true	true
ServicesAtStopAre-NormallyAccessible	true	true	true	true	

9.9 Example 9: Metro Station with Bus & Light Rail

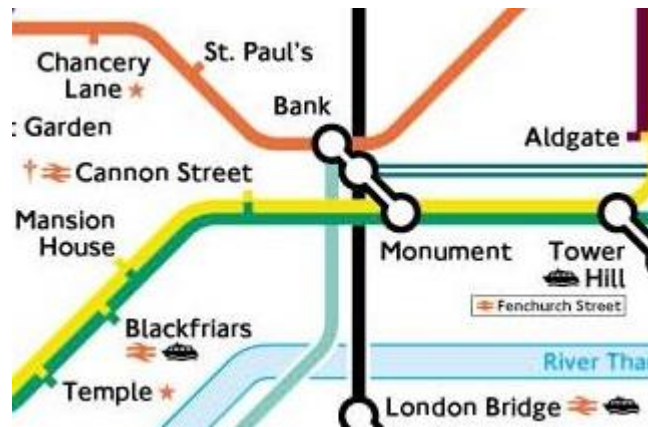

Source Transport for London Journey Planner MDV gmbh

Figure 9-20 – Example 9: Bank Tube Lines

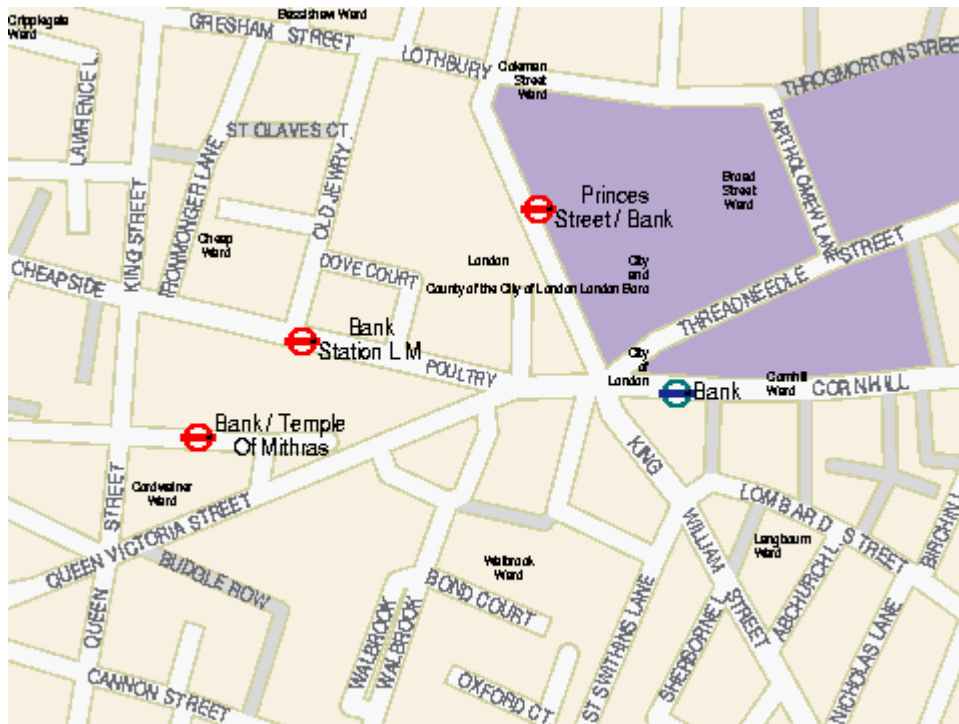

Source Transport for London Journey Planner, MDV gmbh.

Figure 9-21 – Example 9: Bank Station Street Area

This example considers 'Bank' underground station in the 'City of London', which connects two tube lines ('Northern' and 'Central') the 'Waterloo and City' (Figure 9-20) with the Docklands Light Railway. There are several bus stops in the vicinity Figure 9-21. However not all the bus stop areas are considered to be part of an interchange with Bank Station. There is a walkable tunnel connection with 'Monument' underground station.

- Metro - 'GTMU'
 - Bank – 10 different entrances 'TMU'.
 - Bank - four 'PLT' platform areas
 - Bank – DLR Access Area. ('MET')
- Bus

- *'Bank' Cluster - 'GCLS'*
 - *Bank, stop C*
 - *Bank, stop F*
 - *Bank, stop R*
 - *Bank, stop S*
- *'Princes Street' Pair - 'GPBS'*
 - *'Princes Street at Bank, stop A'*
 - *'Princes Street at Bank, stop B'*
- *'Bank Station L M' Pair - 'GPBS'*
 - *'Bank Station L M, stop K'*
 - *'Bank Station L M, stop L'*
- *'Bank Temple of Mithras' Cluster - 'GCLS'*
 - *'Bank Temple of Mithras, stop H'*
 - *'Bank Temple of Mithras, stop J'*
 - *'Bank Temple of Mithras, stop JA'*

Figure 9-22 and Figure 9-23 show a possible stop hierarchy - a 'GTMU' stop area is used for the tube station and a 'GPBS' or 'GCLS' stop area for each group of bus stops. The GTMU stop area is used as a parent for the *Bank GCLS* Bus cluster as this is deemed to be close enough to Bank Underground Station to constitute an interchange. This example shows that judgement must be exercised as to which stops constitute a true interchange.

The model in this case has only four PLT elements for the Underground station – each represents a platform used for travel in both directions. This is legacy data – ideally each platform EDGE should now be coded as a separate PLT element so that they can each have the public-facing indicator (Platform 1 or A, etc)

The link to *Monument* creates an entrance to '*Bank*' station, located at the *Monument* (and vice versa). The entrances should be at the same location to create direct connectivity (if supported); otherwise a walk link is needed, which is outside the scope of NaPTAN.

**Bank Underground
Example**

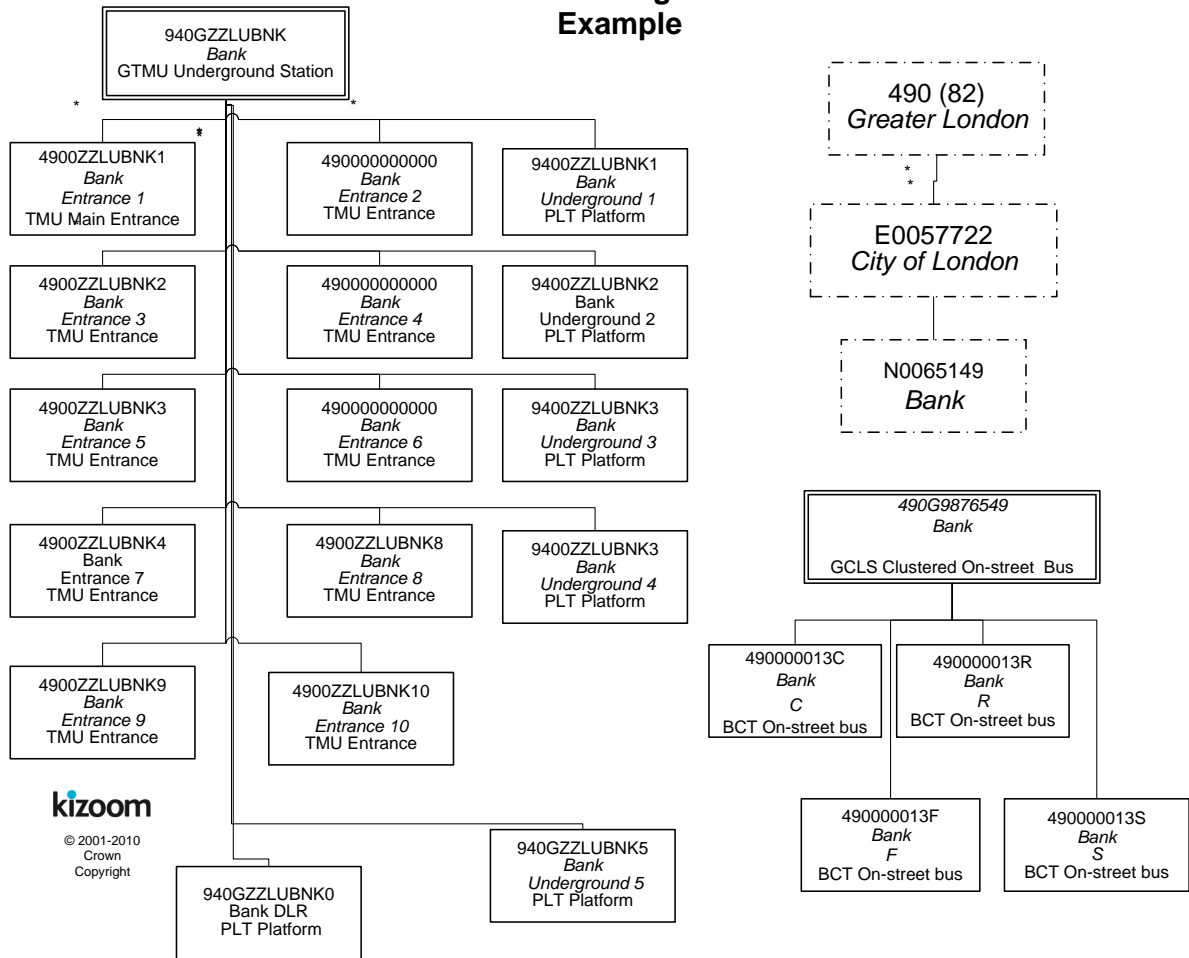

Figure 9-22 – Example 9: Stop Hierarchy for Bank Underground Station

**Bank Underground
Example Continued**

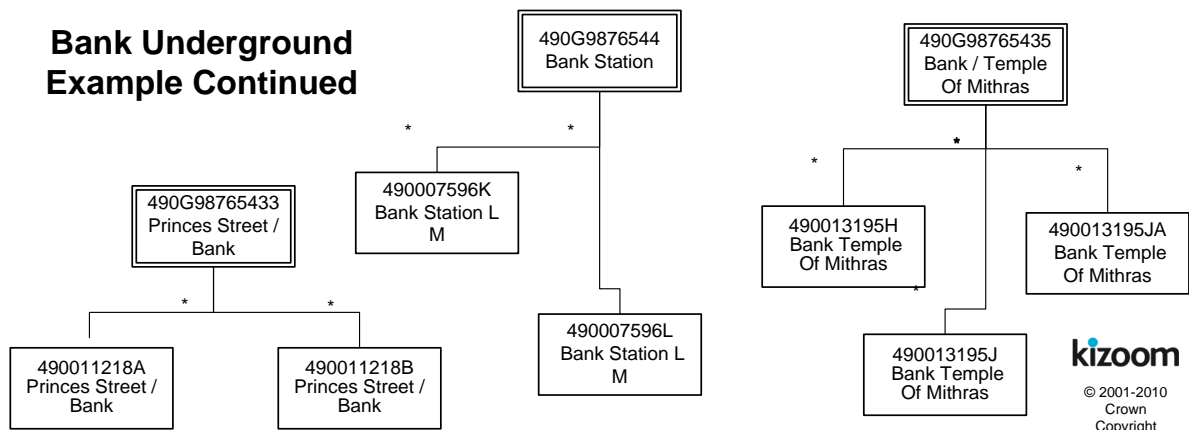

Figure 9-23 – Example 9: Bank Underground Station – Stops in Area

9.9.1 NaPTAN StopArea Definitions: Example 9

Element	Subelement	Stop Areas				
		Metro	Bus Pair 1	Bus Pair 2	Bus Cluster 3	Bus Cluster 4
StopAreaCode		940G ZZLUBNK	490G 98765433	490G 9876544	490G 9876549	490G 98765435
StopArea / Name		Bank Station	Princes Street at Bank	Bank Station LM	Bank	Bank Temple Of Mithras
StopArea Classification		GTMU Metro Station	GPBS On-street bus	GPBS On-street bus	GCLS On-street bus	GCLS On-street bus
Location	Grid Type	UKOS	UKOS	UKOS	UKOS	UKOS
	Easting	532711	532660	532537	532774	532560
	Northing	181112	181209	181139	181173	181053
ParentAreaRef		940G ZZLUBNK	940GZZLUBNK	940GZZLUBNK	940GZZLUBNK	940GZZLUBNK
Administrative Area		940(MET)→Metro National	490 (82)→Greater London	490 (82)→Greater London	490 (82)→Greater London	490 (82)→Greater London

9.9.2 NaPTAN StopPoint Definitions: Example 9

9.9.2.1 Metro Stop Points: Common Values

Element	Subelement	Common Values
Descriptor	Landmark	--
Place	NptgLocalityRef	E0057722 → City of London
	AlternativeNptgLocalityRef	N0065149 → Bank
	Town	--
	Suburb	--
	LocalityCentre	Y
*StopAreaRefs	StopAreaRef	940G98765431 → Bank Station
		490G98765433 → Bank
AdministrativeArea		490 (82) → Greater London

9.9.2.2 Metro Stop Points: Stops

AtcoCode	Stop Type	Bus Stop Type	CommonName	Landmark	Street	Indicator	Bearing	Status	Bank
9400ZZLUBNK0	PLT	--	Bank	Bank	Cornhill	DLR 1	--	ACT	Y
9400 ZZLUBNK 1	PLT	--	Bank	Bank	Cornhill	Under-ground 1	--	ACT	Y
9400 ZZLUBNK 2	PLT	--	Bank	Bank	Cornhill	Under-ground 2	--	ACT	Y
9400 ZZLUBNK 3	PLT	--	Bank-	Bank	Cornhill	Under-ground 3	--	ACT	Y
9400 ZZLUBNK 4	PLT	--	Bank	Bank	Cornhill	Under-ground 4	--	ACT	Y
9400 ZZLUBNK 5	PLT	--	Bank	Bank	Cornhill	Under-ground 5	--	ACT	Y
4900 ZZLUBNK0	TMU	--	Bank	Mansion House	Queen Victoria Street	Entrance 1	--	ACT	Y
4900 ZZLUBNK1	TMU	--	Bank	Mansion House	Poultry	Entrance 2	--	ACT	Y
4900 ZZLUBNK2	TMU	--	Bank	Mansion House	Queen Victoria Street	Entrance 3	--	ACT	Y
4900 ZZLUBNK3	TMU	--	Bank	Royal Exchange	Cornhill	Entrance 4	--	ACT	Y
4900 ZZLUBNK4	TMU	--	Bank	Mansion House	King William Street	Entrance 5	--	ACT	Y
4900 ZZLUBNK5	TMU	--	Bank	Mansion House	King William Street	Entrance 6	--	ACT	Y
4900	TMU	--	Bank	Bank Of	Threadneedle	Entrance	--	ACT	Y

ZZLUBNK6				England	Street	7			
4900 ZZLUBNK7	TMU	--	Bank	Bank Of England	Threadneedle Street	Entrance 8	--	ACT	Y
4900 ZZLUBNK8	TMU	--	Bank	Mansion House	Lombard Street	Entrance 9	--	ACT	Y
4900 ZZLUBNK9	TMU	--	Bank	Mansion House	King William Street	Entrance 10	--	ACT	Y
4900 ZZLUBNKa	TMU	--	Bank	Mansion House	King William Street	Entrance 11	--	ACT	Y
4900 ZZLUBNKb	TMU	--	Bank	Monument	King William Street	Entrance 12	--	ACT	Y
490000013C	BCT	MKD	Bank	Bank Of England	Threadneedle Street	Stop C	E	ACT	Y
490000013F	BCT	MKD	Bank	Mansion House	King William Street	Stop F	S	ACT	Y
490000013R	BCT	MKD	Bank	Royal Exchange	Cornhill	Stop R	E	ACT	Y
490000013S	BCT	MKD	Bank	Royal Exchange	Cornhill	Stop S	W	ACT	Y
490007596K	BCT	MKD	Bank Station L M	Mansion House	Cheapside	Stop K	W	ACT	N
490007596L	BCT	MKD	Bank Station L M	Mansion House	Poultry	Stop L	E	ACT	N
490011218A	BCT	MKD	Princes Street / Bank	Bank Of England	Princes Street	Stop A	N	ACT	N
490011218B	BCT	MKD	Princes Street / Bank	Bank Of England	Princes Street	Stop B	S	ACT	N
490011218N	BCT	MKD	Princes Street / Bank	Bank Of England	Princes Street	Stop N	N	DEL	N
490011218P	BCT	MKD	Princes Street / Bank	Bank Of England	Princes Street	Stop P	S	DEL	N
490013195H	BCT	MKD	Bank / Temple Of Mithras	Temple of Mithras	Queen Victoria Street	Stop H	E	ACT	N
490013195J	BCT	MKD	Bank / Temple Of Mithras	Temple of Mithras	Queen Victoria Street	Stop J	W	ACT	N
490013195JA	BCT	MKD	Bank / Temple Of Mithras	Temple of Mithras	Queen Victoria Street	Stop JA	W	ACT	N

9.9.3 Names in Context

Depending on the application and the other stops data present, some of the stop names might appear variously in context in a finder as follows:

- → 'City Of London, Bank Temple Of Mithras'
- → 'City Of London, Princes Street at Bank'
-

9.10 Example 10: Bus Station with Bays

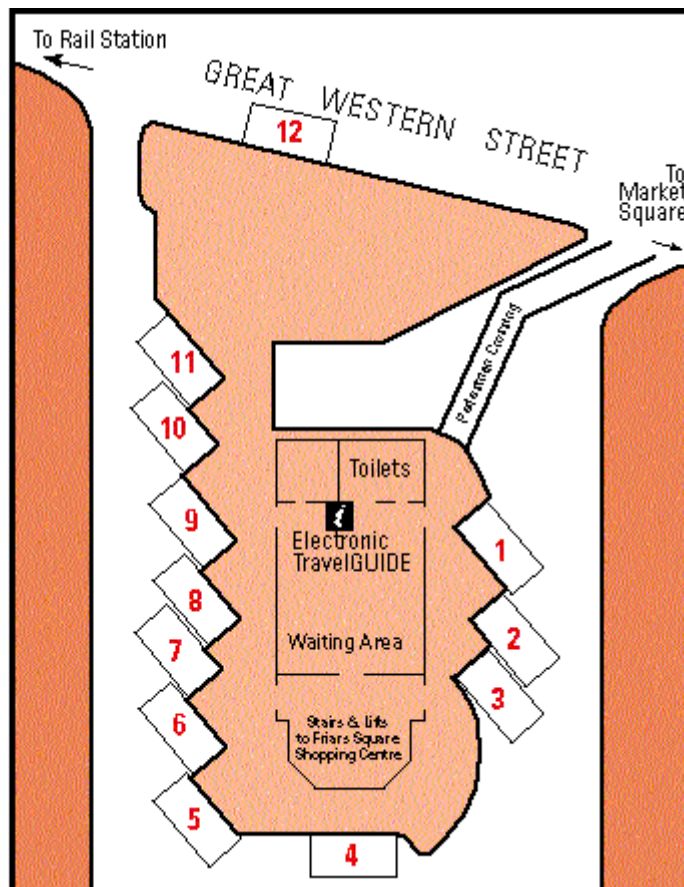

From Bucks Pindar Journey Planner web site, Digital cartography by FWT

Figure 9-24 – Example 10: Aylesbury Bus Station

This example models *Aylesbury Bus Station* which has 12 Bays – see *Figure 9-24*.

- A stop area of type *GBCS* is used to represent the station.
- There is a '*BCE*' stop for the pedestrian entrance.
- Each bay has its own NaPTAN stop of type '*BCS*'.
- If variable bay allocation is needed, there is a variable bay stop of type *BCQ* which can be used when no specific bay is assigned in advance.

There are notes attached to each stop.

	Destination
1	Bicester Road (Rural Services)
2	Town Services to Quarrendon, Haydon Hill and Elmhurst
3	Wendover Road Services
4	Town Services to Southcourt, Walton Court, Hawkslade Farm and Stoke Mandeville Hospital
5	Town Services to Fairford Leys and Southcourt
6	Services to Stoke Mandeville, Princes Risborough, High Wycombe and Reading
7	Tring Road Services to Luton, Hemel and Watford
8	Town Services to Broughton and Bedgrove
9	Services to Haddenham, Thame and Oxford
10	Services to Leighton Buzzard, Bletchley and Milton Keynes
11	Services to Watermead, Winslow and Buckingham
12	Certain school journeys, early morning and late evening departures

Table 9-1 – Example 10: Stop Notes for Aylesbury Bus Station

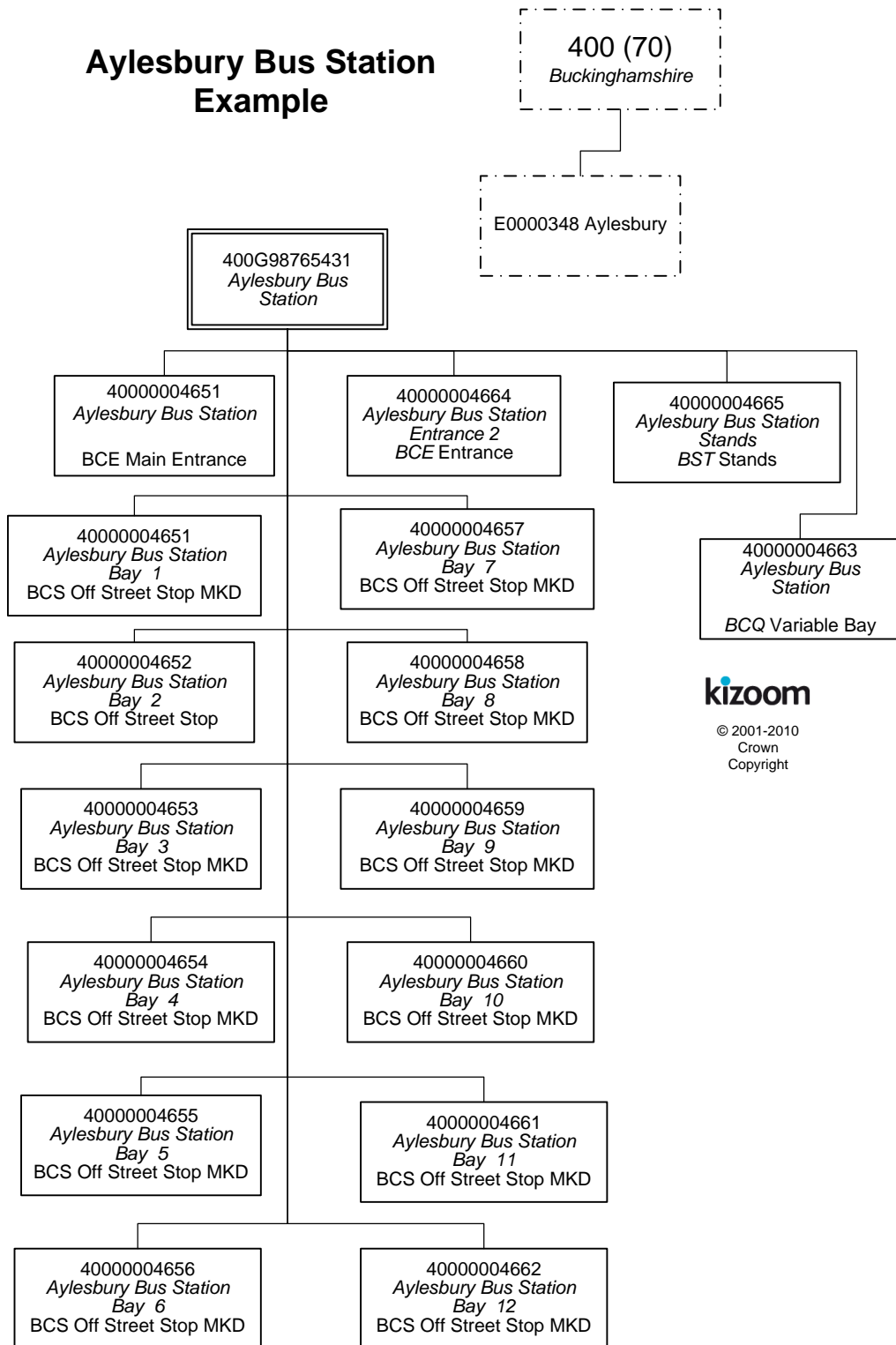

Figure 9-25 – Example 10: Stop Hierarchy for Aylesbury Bus Station

9.10.1 NaPTAN StopArea Definitions: Example 10

		StopArea
Element	Subelement	Bus
StopAreaCode		400G98765431
StopArea / Name		Aylesbury Bus Station
StopAreaType		GBCS <i>Bus Station</i>
Location	Grid Type	UKOS
	Easting	481879
	Northing	213593
ParentAreaRef		--
AdministrativeArea		

9.10.2 NaPTAN StopPoint Definitions: Example 10

9.10.2.1 Bus Station Stop Points: Common Values Example 10

		Common Values
Element	Subelement	
Descriptor	Landmark	<i>Bus Station</i>
Place	NptgLocalityRef	E0000348 → Aylesbury Town Centre
	Town	
	Suburb	
	Street	Great Western Street
	Landmark	Bus Station
	LocalityCentre	Y
*StopAreaRefs	StopAreaRef	400G98765431 → Aylesbury Bus Station
AdministrativeArea		400 (70) → Buckinghamshire

9.10.2.2 Bus Station Stop Points: Example 10

AtcoCode	Stop Type	Bus Stop Type	Easting	Northing	CommonName	Indicator	Timing Status	Status
4000004650	BCE		481881	213599	Aylesbury Bus Station	Entrance		ACT
4000004651	BCS	MKD	481881	213599	Aylesbury Bus Station	Bay 1	PTP	ACT
4000004652	BCS	MKD	481883	213597	Aylesbury Bus Station	Bay 2	PTP	ACT
4000004653	BCS	MKD	481884	213595	Aylesbury Bus Station	Bay 3	PTP	ACT
4000004654	BCS	MKD	481885	213589	Aylesbury Bus Station	Bay 4	PTP	ACT
4000004655	BCS	MKD	481881	213585	Aylesbury Bus Station	Bay 5	PTP	ACT
4000004656	BCS	MKD	481879	213587	Aylesbury Bus Station	Bay 6	PTP	ACT
4000004657	BCS	MKD	481877	213589	Aylesbury Bus Station	Bay 7	PTP	ACT
4000004658	BCS	MKD	481875	213591	Aylesbury Bus Station	Bay 8	PTP	ACT
4000004659	BCS	MKD	481873	213593	Aylesbury Bus Station	Bay 9	PTP	ACT
4000004660	BCS	MKD	481871	213595	Aylesbury Bus Station	Bay 10	PTP	ACT
4000004661	BCS	MKD	481869	213597	Aylesbury Bus Station	Bay 11	PTP	ACT
4000004662	BCS	MKD	481896	213605	Aylesbury Bus Station	Bay 12	PTP	ACT
40000046633	BCQ	MKD	481884	213595	Aylesbury Bus Station	Departures	PTP	ACT

AtcoCode	Note
4000004651	Bicester Road (Rural Services)
4000004652	Town Services to Quarrendon, Haydon Hill and Elmhurst
4000004653	Wendover Road Services
4000004654	Town Services to Southcourt, Walton Court, Hawkslade Farm and Stoke Mandeville Hospital

40000004655	Town Services to Fairford Leys and Southcourt
40000004656	Services to Stoke Mandeville, Princes Risborough, High Wycombe and Reading
40000004657	Tring Road Services to Luton, Hemel and Watford
40000004658	Town Services to Broughton and Bedgrove
40000004659	Services to Haddenham, Thame and Oxford
40000004660	Services to Leighton Buzzard, Bletchley and Milton Keynes
40000004661	Services to Watermead, Winslow and Buckingham
40000004662	Certain school journeys, early morning and late evening departures

9.10.3 Names in Context

Depending on the application and the other stops data present, some of the stop names might appear variously in context in a finder as follows:

- → *Aylesbury, Bus Station, Bay 1*
- → *Aylesbury, Bus Station, Bay 5*
- → *Aylesbury, Bus Station, Bay 8*
- → *Aylesbury, Bus Station, departures {representing the BCQ stop}*

9.11 Example 11: Major Airport

NOTE : This example describes Heathrow as it was several years ago (that is, before the addition of Terminal 5 and the closure of Terminal 2). but it still reflects the relevant principles for constructing a large interchange –

Major Airports are typically especially complex interchange points. We consider an example in summary below.

- There are two physically separate termini groups for Heathrow, with separate access by public transport: *'Heathrow Airport'* and *'Heathrow Terminal 4'*.
 - *'Heathrow Airport'* contains sub areas for *'Terminal 1'*, *'Terminal 2'*, *'Terminal 3'*, *'Terminal 123 Underground Station'*, *'Terminal 123 Heathrow Express Station'*, *'Terminal 123 Bus Station'*, *'Terminal 123 Coach Station'*, and a number of bus and coach stops and taxi ranks.
 - *'Heathrow Terminal 4'* contains sub areas for *'Underground Station'*, *'Heathrow Express Station'* and a number of bus and coach stops and taxi ranks.

To model this in *NaPTAN* we might use:

- An **NptgLocality** *'Heathrow'* to which all of the stops and stop areas can be assigned.
- Each of the four Terminals can be represented in *NaPTAN* by a **StopArea** that groups the various public entrances to each Terminal Building.
- For *'Heathrow Airport'* a **GAIR** group is used to group terminals 1, 2 and 3.
 - The *'Underground Station'* for *'Heathrow Terminal 123'* can be represented by a **GTMU StopArea** that groups the sub-surface entrances to the station.
 - The *'Heathrow Express Station'* for *'Heathrow Terminal 123'* can be represented by a **GRLS StopArea** that groups the sub-surface entrances to the rail station.
 - The Coach station for *'Heathrow Central'* can be represented by a **GBCS StopArea** that groups the individual bays in the coach station (adjacent to Terminal 3).
 - The Bus Station for *'Heathrow Central'* can be represented by a **StopArea** that groups the individual stops/bays in the bus station and the bus station entrances.
 - Outside each terminal there are a number of bus and coach stops used by local and rail-link buses. These are not considered part of the Terminal groupings as they are marked stops on the airport road network.
- For the *'Terminal 4'* area, a similar set of mode stop areas.
 - The *'Underground Station'* for *'Terminal 4'* can be represented by a **StopArea** that groups the sub-surface entrances to the station.
 - The *'Heathrow Express Station'* for *'Terminal 4'* can be represented by a **StopArea** that groups the sub-surface entrances to the rail station.

Figure 9-26 and *Figure 9-27* show a partial stop hierarchy for Heathrow.

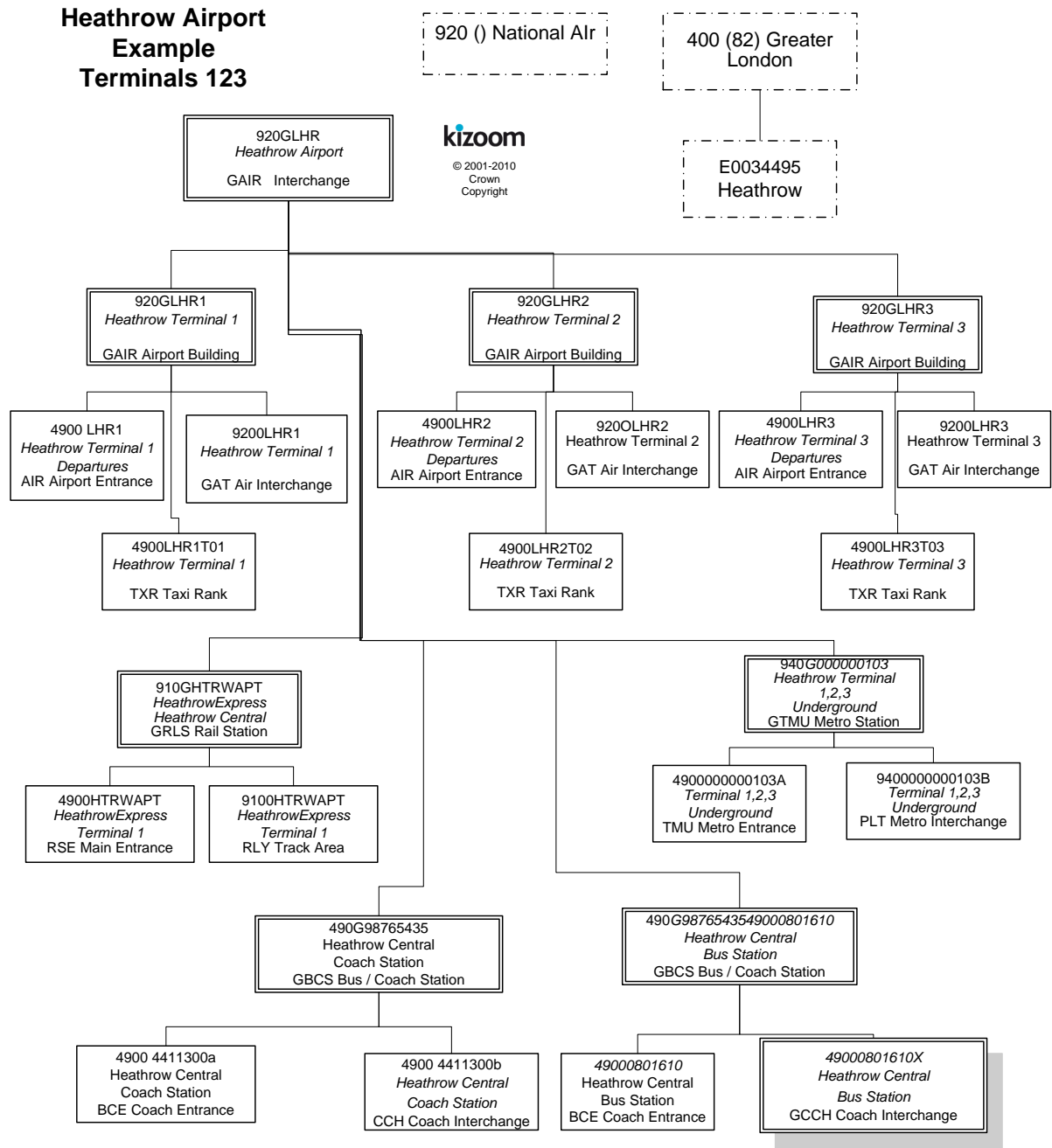

Figure 9-26 – Example 11a: Partial Stop Hierarchy for Heathrow Airport Terminals 123

**Heathrow Airport
 Example
 Terminal 4**

kizoom
 © 2001-2010
 Crown
 Copyright

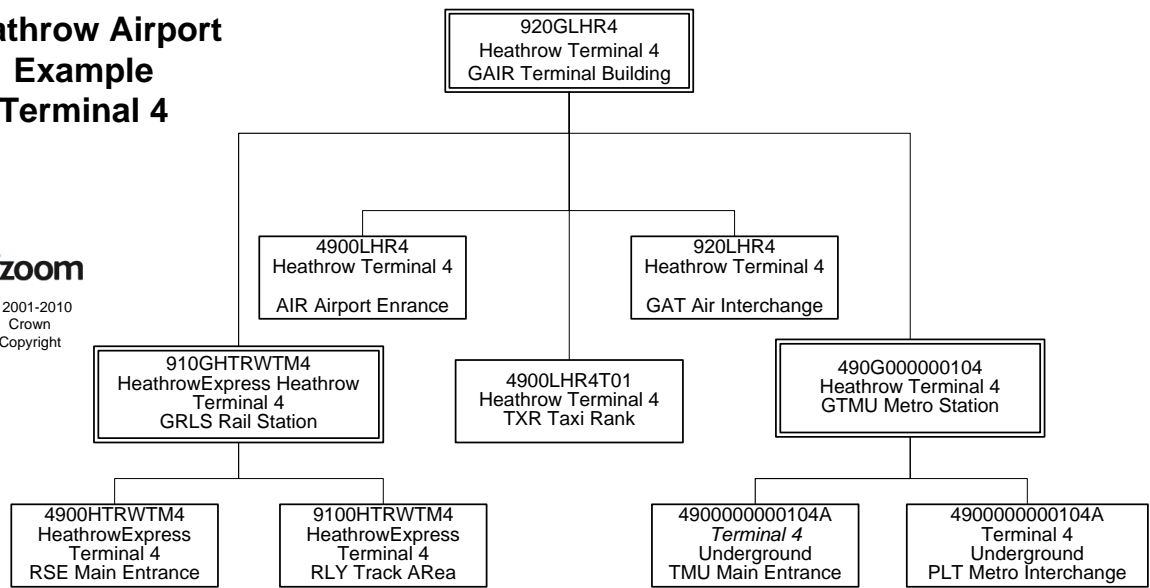

Figure 9-27 – Example 11b: Partial Stop Hierarchy for Heathrow Terminal 4

10 NAMING & CODING CONVENTIONS

Systematic naming conventions and a consistent coding style are used in the *NPTG and NaPTAN 2.x* schemas; these conventions are summarised in this section.

10.1 Naming of Elements

NPTG and NaPTAN follow consistent principles for naming schema elements:

10.1.1 Use of Camel Case

Camel case is used for all names in the XML schema:

- Upper camel case is used for elements and attributes for example **StopArea**, **HailAndRide**.
- Lower case is however used for two standard attributes: *xml:lang*, and *id*, in line with established W3C usage.
- Lower camel case is used for enumerated text values, for example '*saturdayMorning*'.
- Acronyms are treated as words for capitalisation, thus **TanCode**, not **TANCode**. This is one point where we follow common best practice but diverge from e-gif. Treating acronyms as words allows for a uniform parsing of names to derive their components, and avoids ambiguity on case of contiguous acronyms, for example **TANAPD** vs. **TanApd**, or one letter words contiguous with an acronym, for example **DialATAN** vs. **DialATan**.

10.1.2 Use of Standard Name Suffixes

NaPTAN, *NPTG* and *NaPT schema* element, type and attribute names have been revised along consistent principles:

- All simple types end with the suffix '**Type**'.
- All complex types end with '**Structure**'.
- All enumerations end with '**Enumeration**'.
- All groups end with '**Group**'.
- Externally referenced identifiers of entities are generally suffixed with '**Code**' (and represented as elements).
- Internally referenced identifiers are generally suffixed with '**id**' (and represented as attributes).
- Elements representing references to other entities are suffixed with '**Ref**'. (These are either **Code** or **id** data types)
- Externally referenced classifiers of entities are generally suffixed with '**Classification**' (rather than say '**Type**'). For example **StopClassification**
- Externally referenced names of entities are generally suffixed with '**Name**'. If the context is readily apparent they may be called just **Name**.
- Natural Language text descriptions of entities are generally termed '**Description**'.

10.1.3 Meaningful Names

Several other consistent naming principles are followed:

- Abbreviations are generally avoided – for example '**Operation**' is preferred to '**Op**'.
- A container element representing a one-to-many relationship is in the plural; for example, **StopPoints** contains one or more **StopPoint** elements.
- We avoid repeating the name of the parent element as an adjective in individual child elements, except for certain semantically important elements where it is helpful to do so. Thus for example, **Author** contains **Title**, **Position**, **Forename**, **Surname**, not **AuthorTitle**, **AuthorPosition**, **AuthorName**, **AuthorSurname**. An exception to this rule is for **Code** elements, for example **Area / AreaCode** and not **Area / Code**.
- We avoid the use in domain elements names of terms that have strong software connotations:
 - The suffixes '**Type**' and '**Group**' are avoided in element names except for internal schema elements.

10.1.4 Standardised Terminology

An attempt has been made to use the appropriate Transmodel term wherever appropriate. For example **StopPoint** rather than **Stop**, **StopArea** rather than **StopGroup**,

10.1.5 Semantically Significant Order

Several principles are used to order subelements at any given level:

- When declaring elements within a parent, subelements are placed in a consistent general order according to the nature of their role as follows:
 - a. Elements that identify the entity, such as codes or numbers.
 - b. Elements that describe the element in text, such as names or descriptions.
 - c. Principle associations of the entity with other entities.
 - d. Elements that classify the entity.
 - e. Elements describing other properties of the entity.
- Where there is an inherent temporal order, elements are placed in temporal sequence, for example '**StartDate**' before '**EndDate**'.

10.2 Typing of Elements

Some general principles are used for typing values.

- Explicit, specific types are used wherever possible, for example **Duration**:
- Complex types are declared for all significant compound elements.
- Internally referenced identifiers are generally of type NMTOKEN, or an extension.
- Elements whose content is a text string in a national language are of type **NaturalLanguageStringStructure**.

10.3 Element Constraints

Some general principles are used for constraining values.

- *Mandatory Elements are normally populated.* XML constraints are usually specified to ensure mandatory elements are populated, for example strings should contain at least one character.
- *Optional elements not empty:* Where alternative structures are available, the absence of an element is not relied upon to infer meaning. Instead an empty element or attribute value is used to make the condition explicit, or there is a default value defined that can be assumed. This principle has been generally followed for new and remodelled features.

10.4 Use of Attributes

In *NPTG and NaPTAN*, XML element attributes are generally used only for metadata, that is, data about data, such as data version tracking, to identify the data reference systems used, or to provide internal instance identifiers. *Table 10-1* summarises the attributes used in *NPTG and NaPTAN*.

Group	Element	Attribute	ver
Document Version	NaPTAN, NPTG, NptgDiscovery root elements.	CreationDateTime	2.0
		ModificationDateTime	1.2
		FileName	2.0
		Modification	2.0
		RevisionNumber	2.0
		SchemaVersion	1.2
		ChangesSince	2.4
Entity Version	StopPoint, StopArea, Network, TariffZone NptgLocality, NptgDistrict, Region, AdministrativeArea, CallCentre, WebApplication	CreationDateTime	2.0
		ModificationDateTime	1.2
		FileName	2.0
		Modification	2.0
		Status	1.2
		RevisionNumber	2.0

<i>dataRights</i>	All of the above	DataRightRef	2.4
<i>Id</i>	Location	Id	1.2
<i>Data</i>	Location	Precision	1.2
	NaPTAN, NPTG	LocationSystem	2.0
<i>Language</i>	Text elements: Name, Description , etc. See section on National Language Support	xml:lang	2.0

Table 10-1 – NaPTAN Attributes

10.5 Implementation of Model Relationships

In *NPTG* and *NaPTAN*, some stylistic conventions are used to make clear the mapping of the reference model relationships into the XML schema.

- All significant entities have a uniquely scoped identifier (always an element named **xxxCode** or **xxxNumber**, or an **id** attribute).
- Relationships are implemented by placing a reference to the identifier as a foreign key on the referencing element (shown by the navigability arrow in UML diagrams). The reference has the form **xxxRef**. For example, **StopPoint** is identified by an **AtcoCode**, and is referenced in relationships by a **StopPointRef**.
- Container elements are generally used for significant one-to-many relationships, with a name derived from the plural name of the contained or referenced element, for example:
 - To implement the aggregation relation of stops within NaPTAN, the **StopPoints** element contains a collection of **StopPoint** instances.
 - To implement the reference relationship of alternative localities from **StopPoint** to The **StopPoint /AlternativeLocalities** container element contains a collection of **NptgLocalityRef** instances.

10.6 Data Rights attribute

A new attribute **DataRightRef** is added in release 2.4 This allows each entity to be associated with a data right element to specify IPR & conditions of use. This is for use with the TransXChange 2.4 Schema – see the 2.4 Schema guide.

11 VERSIONING

NPTG and NaPTAN schemas and documents are versioned so as to manage change in a distributed computational environment, and in particular to allow inter-operability of concurrent versions at different levels.

11.1 Version Numbering Convention

NPTG and NaPTAN schemas follow the e-Gif convention for version numbering.

- *Released* schema Version numbers have the form *n.m*, (e.g. 3.1).
- Drafts have the form *n.mx* (e.g. 3.1a).
- The main version number (*n*) will be incremented when the change from the previous version of the schema will cause existing documents to fail to validate. For example if a new mandatory element is added.
- The minor version number (*m*) will be incremented when the change to the schema will allow existing documents to continue to validate. However some new documents may fail to validate against the old version (for example, if a new optional element is added).
- The draft version number (*x*) indicates that the version is still under discussion and may be subject to further changes. Generally it will be incremented to indicate a material change to a previous release or previous draft. Intermediate drafts will usually be withdrawn once they are superseded.

11.2 Resource Versions

11.2.1 Schema URI version

In line with W3C practice, a separate directory and URL will be used for each version of the schema; the schema name will remain the same.

For example:

```
http://www.naptan.org.uk/schemas/2.1/NaPTAN.xsd
http://www.naptan.org.uk/schemas/2.1/NPTG.xsd
http://www.naptan.org.uk/schemas/2.1/NPTG_Discovery.xsd
```

And:

```
http://www.naptan.org.uk/schemas/2.4/NaPTAN.xsd
http://www.naptan.org.uk/schemas/2.4/NPTG.xsd
http://www.naptan.org.uk/schemas/2.4/NPTG_Discovery.xsd
```

Different versions of the *NaPTAN* schema will coexist at the same time. Older versions will be deprecated and then be dropped altogether after a period.

11.2.2 Namespace URI version

The following unversioned URI will be used for the *NPTG and NaPTAN* namespace. This is in line with the e-GIF mandate that namespace URI must not be versioned.

```
http://www.naptan.org.uk/schemas/
```

11.2.3 Schema Version

In each XML instance document conforming to *NaPTAN* or *NPTG*, the root element (i.e. **NaPTAN** and **NationalPublicTransportGazetteer**) has a **SchemaVersion** attribute that is populated to indicate the schema version, as recommended by e-GIF. This allows any application which processes the document to decide how to handle the document. See *Table 11-1*. A standard set of metadata attributes to track the document is also included:

Attributes	Value
CreationDateTime	Date and Time stamp
ModificationDateTime	Date and Time stamp
Modification	Nature of modification: one of <i>new</i> , <i>delete</i> , <i>revise</i>
ModificationNumber	Sequentially incrementing number
SchemaVersion	Schema Version number

Table 11-1 – NPTG and NaPTAN Document Version Attributes

11.2.4 Package Versions

NPTG and *NaPTAN* embed a number of common type definition packages that are shared with other UK standards. For convenience, a separate copy of the common packages is distributed with each standard. The individual package files are given version numbers in line with the e-GIF system in order to ensure the correct version is used. This number is only incremented if the package changes and so may vary from package to package and be different from the overall schema number. For example, for the shared NaPT stop definition types file might be called *NaPT_stop-v1-0.xsd*. It is distributed in *NaPTAN* 2.1 as:

- http://www.naptan.org.uk/schemas/2.1/napt/NaPT_stop-v2-0.xsd

And if updated in *NaPTAN* 2.4 as:

- http://www.naptan.org.uk/schemas/2.4/napt/NaPT_stop-v2-1.xsd

11.2.5 Data Element Version

Data element versioning indicates the version level of the content of a particular individual item of data. See *Figure 11-1*.

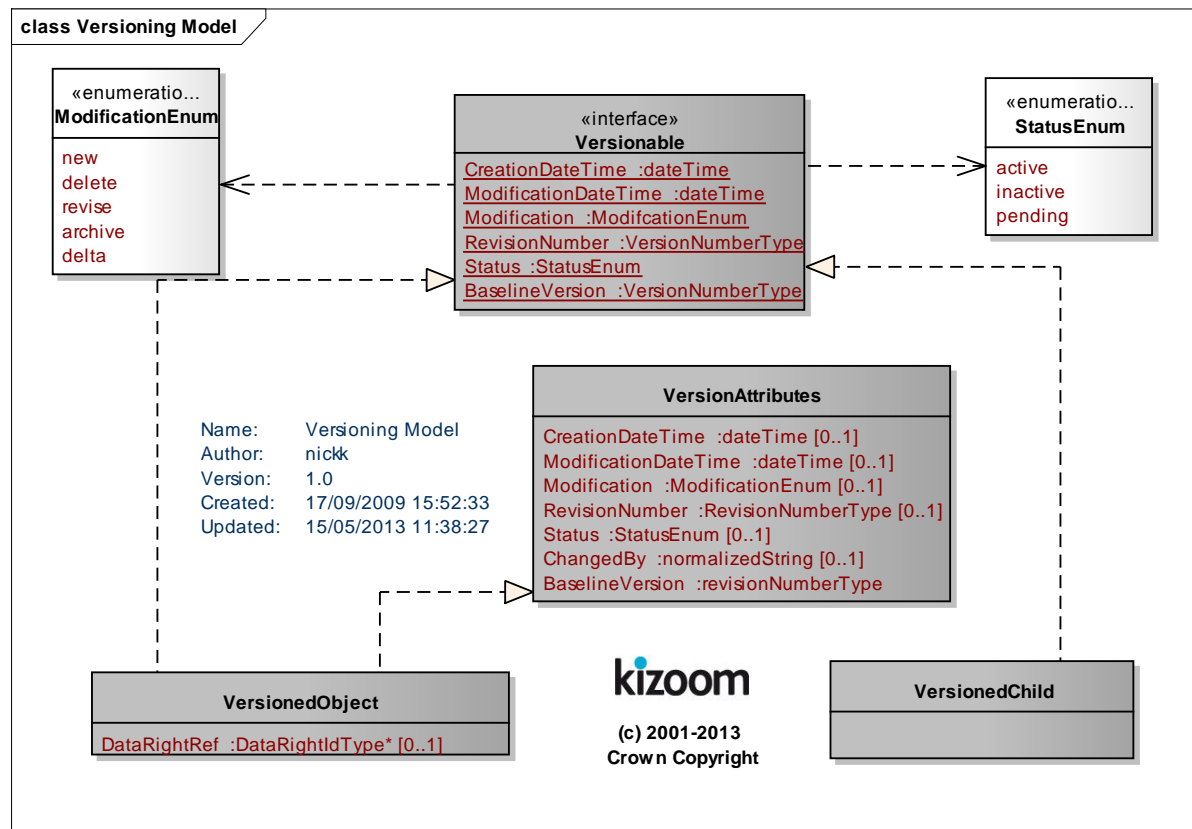

Figure 11-1 – UML Model of Element Versions

Most significant entities in *NPTG and NaPTAN* have optional change attributes on them including a modification date and revision number that can be used to specify their data version level. See *Table 11-2*.

Change Attributes	Type	Use	Intr odu ced
Creation-DateTime	Date and Time stamp in ISO format.	Should be set when the entity is first created, and not subsequently be changed.	2.0
Modification-DateTime	Date and Time stamp in ISO format	Should be changed every time an entity is changed, that is when any of its immediate attributes or any of its child entities are changed. May be omitted if Modification is new, i.e. if same as CreationDateTime otherwise must be specified.	1.2
Modification	Nature of modification: one of <i>new, delete, revise, archive</i>	The Modification status should be set as follows: <ul style="list-style-type: none"> New - If this is the first version of the element instance, created for the first time. An entity continues to have a status of <i>new</i> until it is revised. The creation date can be used to detect a recent addition. Revise - If an existing element instance is being updated, or any of its child elements that are not themselves versioned are being updated, added, or deleted. Once an element is marked as <i>revise</i> it will continue to be so unless it is marked as deleted, i.e. should not ever revert to <i>new</i>. If no value is specified, <i>revise</i> will be assumed. Delete - If the element is being rendered inactive. Records marked as <i>deleted</i> should continue to be exported in subsequent data exchanges. It is possible to reactivate deleted stops: a reactivated stop has a status of <i>revise</i>, (not <i>new</i>). Archive - If the element is archived. It will be held in the central database and the NaPTAN identifiers reserved (Both <i>AtcoCode</i> and <i>NaptanCode</i>), but will be excluded from exports. 	2.0

RevisionNumber	Sequentially incrementing number	The RevisionNumber an instance should be incremented (and its Modification value set to <i>'revised'</i>), if any of its element values, attribute values or contained values are modified by the Originating system. <ul style="list-style-type: none"> New entities should have a revision number of 0. Only the Issuer should increment this number The RevisionNumber of an instance should not be changed if there is no change to the data values or children of an element.	2.0
Status	<i>Active Inactive Pending.</i>	Indicates whether after the modification the element will be considered active, inactive, or pending, (i.e. inactive subject to verification) Stops and Stop Areas are not deleted from the NaPTAN database; instead they are given a status of inactive - see Data Deprecation.	1.2, 2.0

Table 11-2 – Entity Change Tracking & Status Attributes

11.2.6 Use of the Status Attribute

11.2.6.1 Data Deprecation

As a general principle, *referenced entities such as localities, stop points and stop areas will not be deleted from the NPTG and NaPTAN databases, merely deprecated.* This will uphold the referential integrity of systems that use the data.

StopPoint and **StopArea** instances in the *NaPTAN* database may have one of three states, as indicated by the **Status** attribute:

- 'Active'**: Stop is either in use or available to be used.
- 'Inactive'**: Stop is in database but is marked as *'inactive'* and is not currently in use or available for use. If the **StopAvailability** (see 6.9) has been used to transfer or suspend the stop for the period within which the data is published, the status of the stop must be *'active'*. This represents a change of interpretation with release 2.4 – and ensures that stops remain available for Bus Service Registration and other purposes whilst it is temporarily suspended or transferred.
- 'Pending' delete**: Stop is missing, or flagged as deleted from the most recent data upload, and may be in process of being made inactive. Will continue to be exported as if *'active'* until status is clarified.

However for practical reasons very old and unused stop data may occasionally be archived once it has been ascertained that it is no longer referenced by any currently active system (there may still be legacy data references). This may happen in particular for example where an entire area is assigned to a different code. See **Modification** element. Archive data will be omitted from the export. Archived stop identifiers will not be recycled.

Figure 11-2 and Figure 11-3 show the processing states for NaPTAN elements. Note that there are cross-constraints between the two states.

- An *active* element may have a **Modification** attribute value only of *new* or *revise*.
- Only an *inactive* element may have a **Modification** attribute value of *delete* or *archive*.



Figure 11-2 – *Status* element: State Transitions

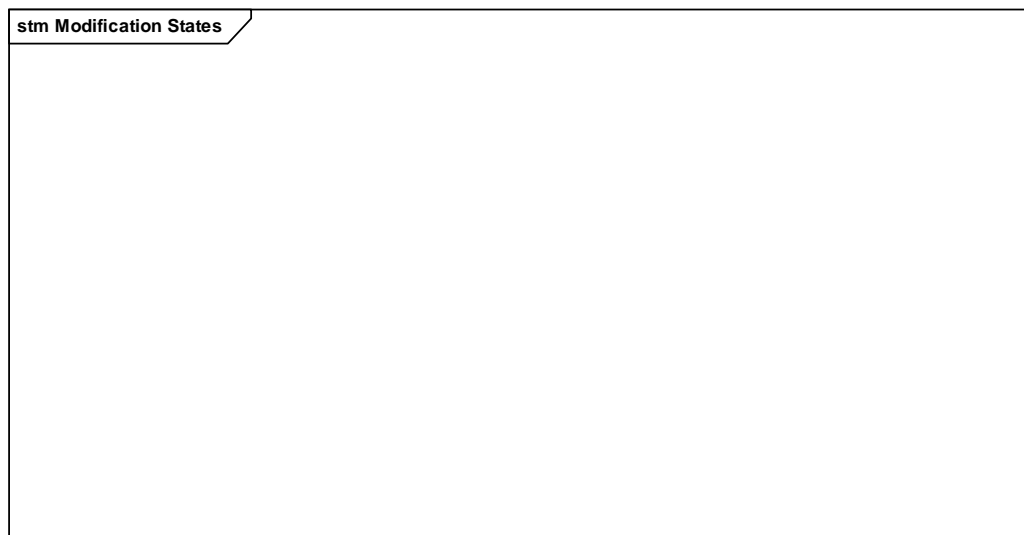

Figure 11-3 – *Modification* element State Transitions

11.2.6.2 Interaction of Status with References to elements

Where an association is used to link two elements (for example for a **StopPoint's StopArea**, **AdministrativeArea**, or **PlusbusZone**), the associated entity should be 'active' at the time the association is created. If the associated entity is subsequently made 'inactive', the association (if not explicitly removed as well) is also considered to be 'inactive' and may be ignored.

11.2.6.3 Interaction of Status with StopValidity

The **Modification** and **Status** elements are general change management attributes found on all elements. The **StopValidity** element is an additional status element found only on **StopPoint** elements.

A stop may also have a **StopValidity** of *Active*, *Suspended*, or *Transferred* as specified by the StopValidity that applies at the period specified for the individual **StopValidity**. The **StopValidity** states and transitions are shown in Figure 11-4.

The **StopValidity** is independent of the 'Status' attribute - though normally it is only useful to specify a StopValidity for an active stop. (Note that TXC v 2.4 revises the interpretation of the interaction with Status – previous to TXC v2.4 the status was required to match the **StopValidity** at the time of export).



Figure 11-4 – StopValidity State Transitions

11.2.6.4 Elements Which can be change tracked

The NaPTAN and NPTG entities which can be change tracked are shown in Table 11-3. For some of these a creation date must always be given (indicated by an 'R'); for others, all the modification attributes are optional in the schema.

	Entity	Type	Versioning	Creation date
NaPTAN	NaPTAN	Root	SchemaVersion.	R
NPTG	NationalPublicTransportGazetteer	Root	SchemaVersion.	R
NaPTAN	StopPoint	Entity	Change Attributes + Status	R
	StopArea	Entity	Change Attributes + Status.	R
	StopPoint / AlternativeDescriptor	Child	Change Attributes.	R
	StopPoint / StopAreaRef	Ref	Change Attributes.	O
	StopPoint / PlusbusRef	Ref	Change Attributes.	O
	StopPoint / AlternativerNptgLocalityRef	Ref	Change Attributes.	O
	StopPoint / MainStopForNptgLocalityRef	Ref	Change Attributes.	O
	StopPoint / HailAndRide	Child	Change Attributes.	O
	StopPoint / FlexibleZone	Child	Change Attributes.	O
	StopPoint / Marked	Child	Change Attributes.	O
	StopPoint / Unmarked	Child	Change Attributes.	O
	StopPoint / StopValidity	Child	Change Attributes.	O
	StopPoint / AnnotatedAirRef	Child	Change Attributes.	O
	StopPoint / AnnotatedFerryRef	Child	Change Attributes.	O
	StopPoint / AnnotatedMetroRef	Child	Change Attributes.	O
	StopPoint / AnnotatedRailRef	Child	Change Attributes.	O
StopPoint / AnnotatedCoachRef	Child	Change Attributes.	O	
	StopPoint / StopAccessibility	Child	Change Attributes.	O
	StopPoint / TarrifZoneRef	Child	Change Attributes.	O
	Network	Entity	Change Attributes + Status	R
	TariffZone	Child	Change Attributes + Status	R

NPTG	Region	Entity	Change Attributes.	R
	AdministrativeArea	Entity	Change Attributes.	R
	NptgLocality	Entity	Change Attributes.	R
	NptgLocality / ParentLocalityRef	Ref	Change Attributes.	O
	NptgLocality / AlternativeDescriptor	Child	Change Attributes.	O
	NptgLocality / AdjacentLocalityRef	Ref	Change Attributes.	O
NPTG Discovery	AdministrativeArea / NptgDistrict	Ent	Change Attributes.	O
	CallCentre	Ent	Change Attributes.	O
	WebApplication	Ent	Change Attributes.	O
	WebApplication / RegionRef	Ref	Change Attributes.	O
	WebApplication / AdminAreaRef	Ref	Change Attributes.	O
	WebApplication / NptgLocalityRef	Ref	Change Attributes.	O
	WebApplication / StopPointRef	Ref	Change Attributes.	O
	TrustedServer	Entity	Change Attributes.	O
	AdjacentRegion (ExchangePoint)	Entity	Change Attributes.	O
	TrunkLocality	Entity	Change Attributes.	O

Table 11-3 – Tracked Data Elements

11.2.6.5 Schema Enforcement of Required Change Attributes

In the NaPTAN schema the attributes are defined by two different attribute groups, as shown in *Table 11-3* above. For elements indicated by an 'R' in *Table 11-3*, a **CreationDateTime** is required, for the other entities a **CreationDateTime** is optional. If a **CreationDateTime** is not present, it is assumed to be the same as for the parent. *Table 11-4* summarises

Change Attributes	Entity	Other
CreationDateTime	R	O
ModificationDateTime	O	O
Modification	O	O
RevisionNumber	O	O
Status	O	O

Table 11-4 – Change Attribute Groups

As a general principle, *referenced entities such as localities, stop points and stop areas will not be deleted from the NPTG and NaPTAN databases, merely deprecated.* **StopPoint** and **StopArea** instances in the NaPTAN database may have one of three states, as indicated by the **Status** attribute:

11.2.7 Detecting Changes on Different systems - The NaPTAN Distributed Data process

The NaPTAN workflow is a distributed collaborative process: data is originated on different systems then merged and propagated to other systems. As a result different version of data be extant on different systems at the same time. Furthermore in some circumstances changes to the same data may be made in parallel on separate systems which then subsequently need reconciling.

The main NaPTAN data process typically involves three participant roles: (i) **Data Originator** (PTEs, Local Authorities and other organisations acting as Administrative Areas); (ii) **Data Distributor** (Landmark Information Group & NaPTAN Database) and; (iii) **Data Consumer** (Journey Planners and other systems).

- Data Origination is carried out by a large number of stakeholders, who collect and maintain stop data and then publish and submit it to the Distributor.
- Data Distribution is carried out as a central service by Landmark Information Group. The Distributor may augment the data, for example translating coordinates. The distributor republishes the data to send it to consumers.
- Data Consumption involves downloading the data from NaPTAN.

The roles of Originator and Consumer can be combined - thus an organisation may update its own data set with data returned by the distributor. When communicating sets of stop data, it is also possible for the central distribution step to be bypassed – for example an Originator may give a set of stop data directly to a Data Consumer, or a TransXChange Schema containing embedded NaPTAN data.

In the normal processing cycle for NaPTAN data, stop data is gathered and edited on a system of the Originating organisation, then exported to the central database as a NaPTAN document where it is integrated and then redistributed as a new NaPTAN document, both to the Originator and to other organisations. The submitting system (or indeed any other consumer of NaPTAN data) therefore may wish to have an efficient way of determining whether any of the returning data elements have changed - and so are in need of reconciliation with other changes that have been made locally on it in the meantime since the last export.

The change attributes allow the importing system to determine whether an element has changed without needing to compare the many individual attributes and children of an individual element instance.

The **modificationDateTime**, together with the **revisionNumber** provides an effective indication that a change has occurred.

- Whenever *the Originator* of the data changes a value of an element, it should update the **modificationDateTime** and the **revisionNumber** of that element.
- Whenever a participant *other than the Originator* changes a value of an element, it should update the **modificationDateTime** but *not* the **RevisionNumber** of that element.

11.2.7.1 Detecting Change when re-importing to an Originating System

An *Originating* system re-importing data may therefore deduce the following:

- If the **revisionNumber** for an element instance is lower, (it should never be higher) than the values in the importing system, the data is an earlier instance and can be ignored.
- If the **revisionNumber** and the **modificationDateTime** for an element instance are *the same* as the values the importing system holds, the content should already be the same and no reconciliation is needed.
- If the **revisionNumber** is the same as the value the importing system holds but the **ModificationDateTime** is different, the data has been augmented or modified by another system: the detailed differences for that element can be examined on a value by value basis and accepted or rejected.

11.2.7.2 Detecting Change when re-importing to an another System

Any other (i.e. non-originating) Distributor or Consumer system importing data may deduce the following:

- If the **revisionNumber** for an element instance is *lower* than the value in the importing system, the data is an earlier instance and can be ignored.
- If the **revisionNumber** for an element instance is *higher* than the value in the importing system, the data is a later instance and should be used to update the consumer's content. (Note that this policy assumes that any other intervening third party changes should be discarded in favour of the new official version – other more elaborate reconciliation policies could be used if the application wishes).
- If the **revisionNumber** and the **modificationDateTime** for an element instance are *the same* as the values the importing system holds, the system's data is already current and no reconciliation is needed.
- If the **revisionNumber** is *the same* as the value the importing system holds, but the **modificationDateTime** is *different*, the data has been augmented or modified by another system: the differences can be examined on a value by value basis and accepted or rejected.

11.2.7.3 Edge cases not currently covered

We note that the above scheme should be adequate for current NaPTAN workflow, but it is not completely foolproof: if two intermediate (i.e. non Originating systems) happened to make different changes to the same element instance of a given **revisionNumber** at exactly the same **modificationDateTime**, a consuming system that assumed equivalence between subsequent imports would be in error.

11.2.8 Summary of Use of Data Version Attributes

The set of principles to follow in using the change attributes is summarised in Table 11-5.

	Principle
1	The CreationDateTime of a data instance must be set by the Issuer (i.e. Originating Administrative Area) when an element is created and never subsequently be altered.
2	The RevisionNumber of a data instance is set only by the issuer, i.e. originating Administrative Area. It should be set to zero for a new instance and be incremented serially for subsequent updates.
3	The RevisionNumber of a data instance is only incremented monotonically (i.e. upwards by one or more at a time)
4	The RevisionNumber and ModificationDateTime of a data instance must be changed every time a data value of an element instance is changed by an Issuer i.e. Originating Administrative Area.
5	The ModificationDateTime (but not the RevisionNumber) must be changed to the current timestamp every time a data value is changed by a party other than an Issuer (e.g. the data aggregator when correcting default values). The current ModificationDateTime number should be shown every time the data is published.
6	If a child element instance is marked as changed, <i>its parent must also be marked as changed.</i>
7	If a child element instance is added, it should be marked as new, and its parent must also be marked as changed.
8	If the values of an element instance have <i>not</i> changed, its RevisionNumber and ModificationDateTime must <i>not</i> be changed.
9	The ModificationDateTime must be later than the CreationDateTime . The ModificationDateTime associated with a higher RevisionNumber must be later than that of any earlier revision number for the same element instance.
10	In a NaPTAN or NPTG document, the root instance should be treated as a parent of all other instances: if the child instances have been altered or added since the last export, the RevisionNumber and ModificationDateTime on the root instance should reflect the change.
11	Provided the above are followed, the RevisionNumber + ModificationDateTime can be used together to compare any two versions of an element instance for difference. If they are both identical then their contents will be the same.
12	In order to avoid loss or corruption of change attribute data, data submitted by the issuer (i.e. Originating Administrative Area) should be in NaPTAN v2.x format.
13	The Modification attribute value of newly created elements should be <i>new</i> . The value of modified elements should be <i>revise</i> . The value of deleted elements should be <i>delete</i> . The value of archived elements should be <i>archive</i> .

Table 11-5 – Data Element Change Versioning Principles.

11.2.9 Referential Integrity of references

In order to serialise NaPTAN data for exchange in an XML file, associations between different entities are output as references. For example, if a **StopPoint** is in a **StopArea**, it will have a **StopAreaRef** instance referencing the identifier of that **StopArea**. Each reference has individual change attributes, allowing each association instance to be individually change-tracked and/or be marked as inactive. If either the referenced or referencing entity is marked as inactive, then the associations also become inactive:

1. If a *parent element containing outward references* is marked as inactive, then its outward references are also considered inactive - and should also be marked as inactive. . For example, if a **StopPoint** is marked as inactive, then all of its child **StopAreaRef** instances should be considered as inactive.
2. If the *referenced element* is marked as inactive, then any references to it should also be treated as inactive. For example, if a **StopArea** is marked as inactive, then any

StopAreaRef held in another StopPoint should be considered as inactive, even if they have not been explicitly marked as such.

An application that holds a NaPTAN data set in a model may choose either to cascade inactivation changes automatically, or to prevent deletion until they have been done

11.3 Packages

The *NPTG* and *NaPTAN* schemas are modularised into a number of packages, with a strict linear dependency. See *Figure 11-5* to *Figure 11-6*.

11.3.1 NPTG Package & Model Dependencies

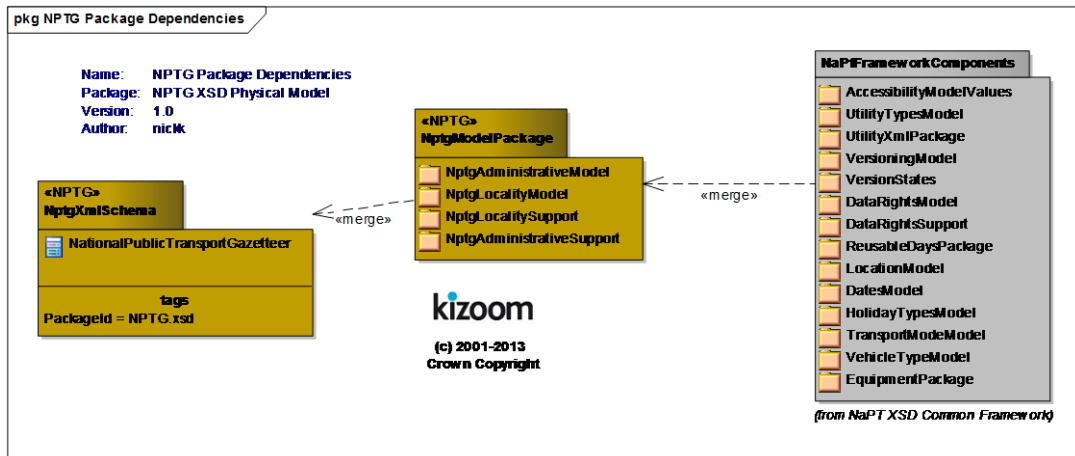

Figure 11-5 – NPTG Packages

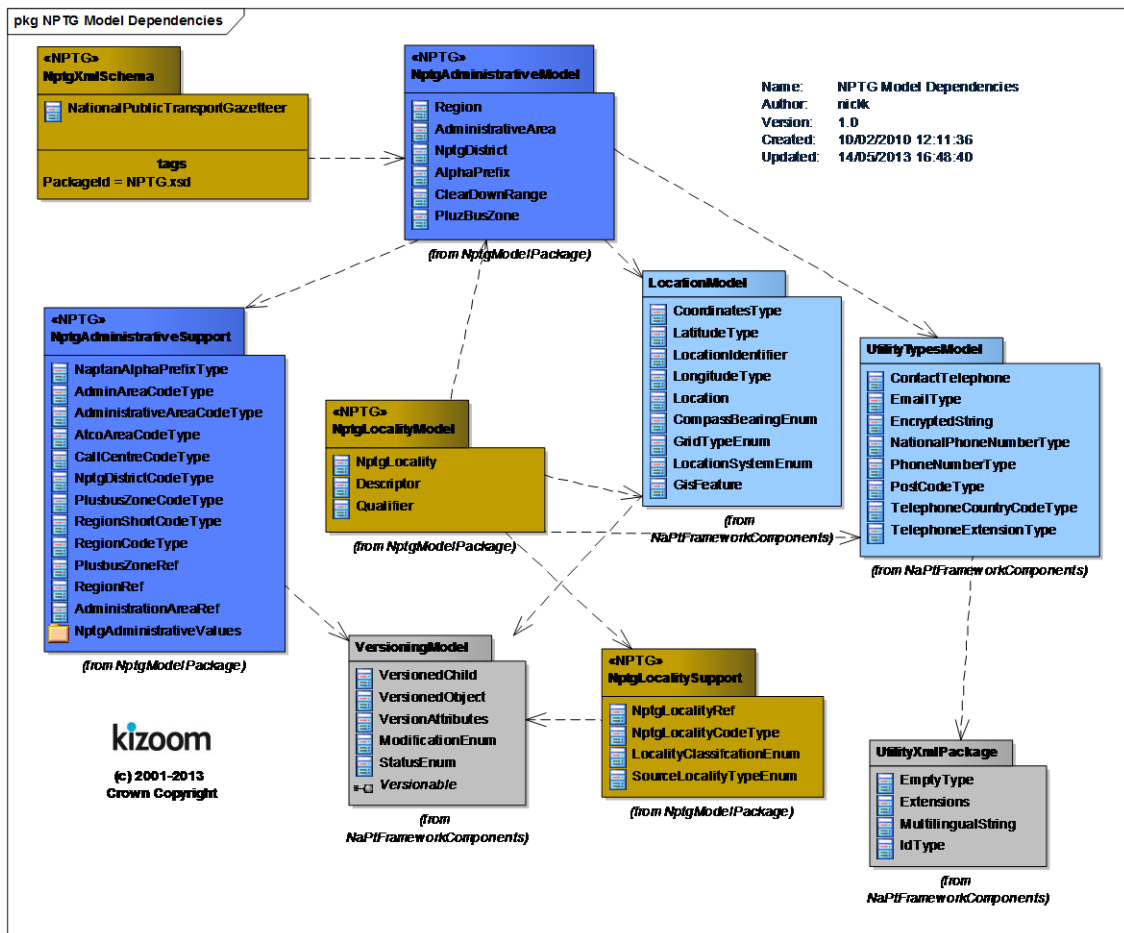

Figure 11-6 – NPTG Models

11.3.2 NPTG Discovery Package & Model Dependencies

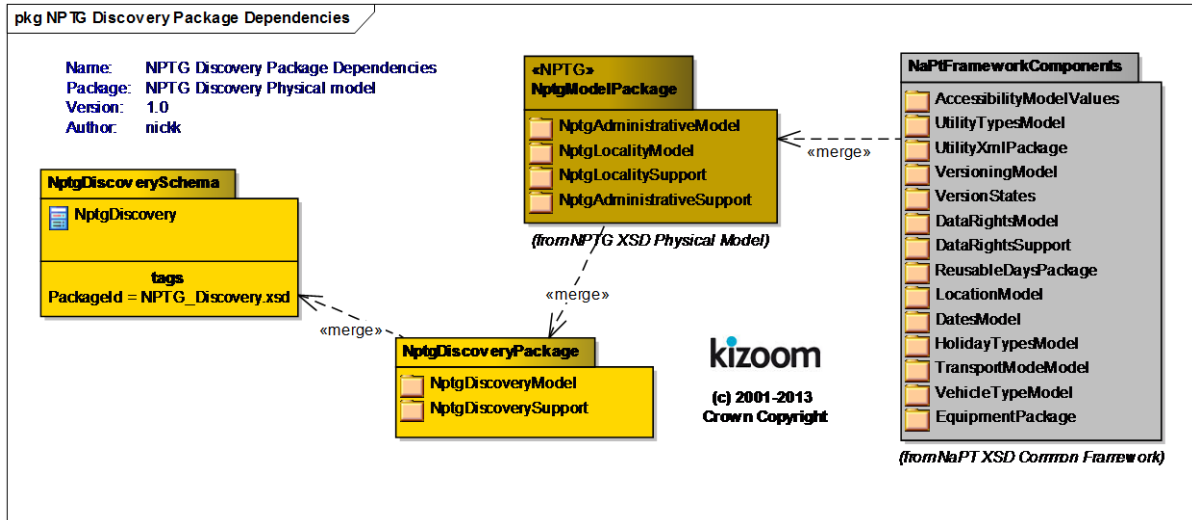

Figure 11-7 – NPTG Discovery Packages

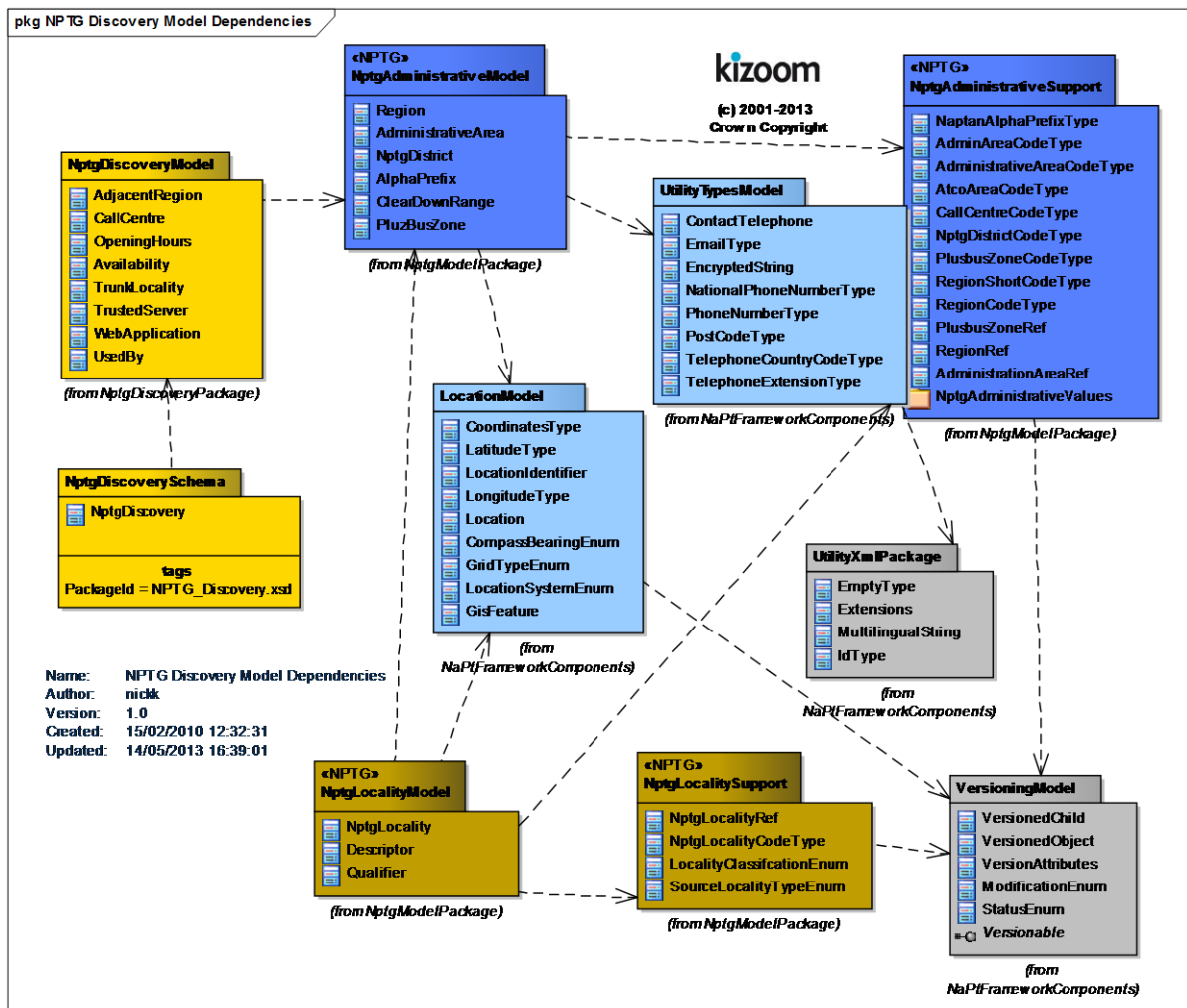

Figure 11-8 – NPTG Discovery Models

11.3.3 NaPTAN Package & Model Dependencies

The NaPTAN schema is modularised into a number of packages, with a strict linear dependency. See Figure 11-9 & Figure 11-10.

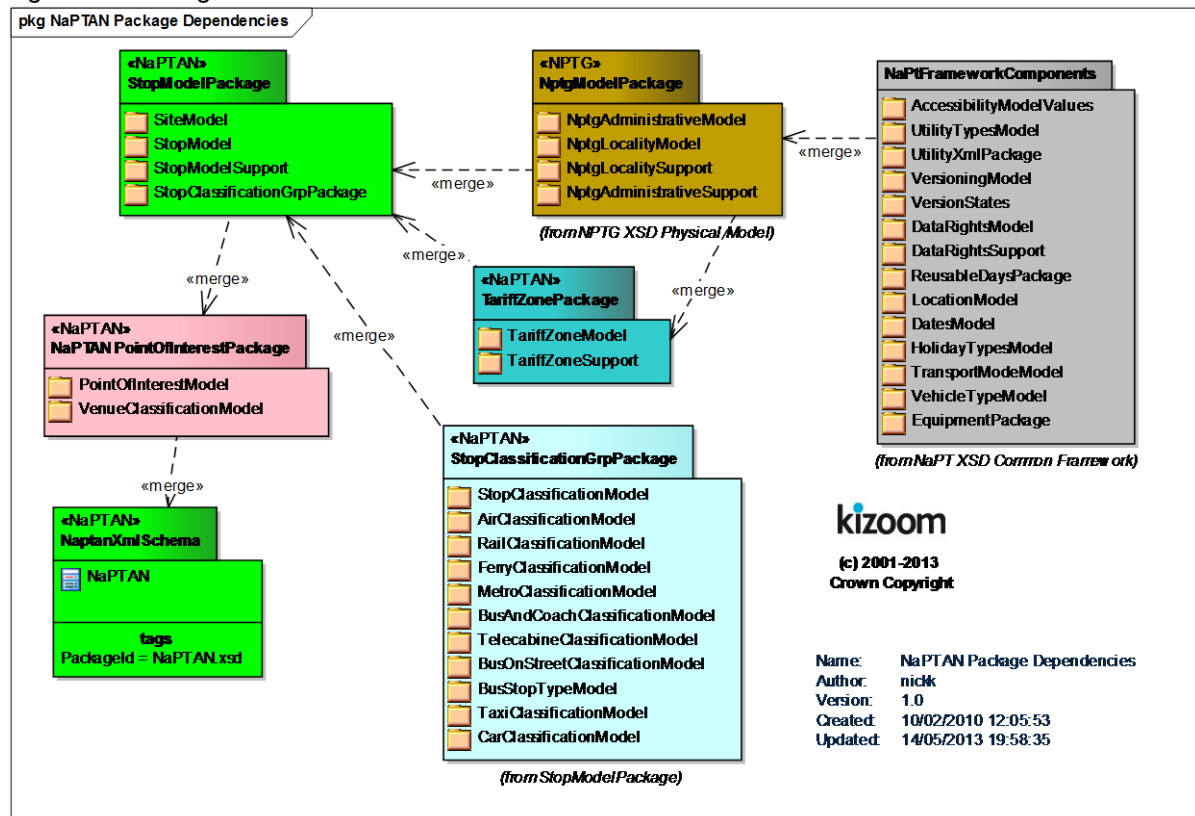

Figure 11-9 – NaPTAN Packages

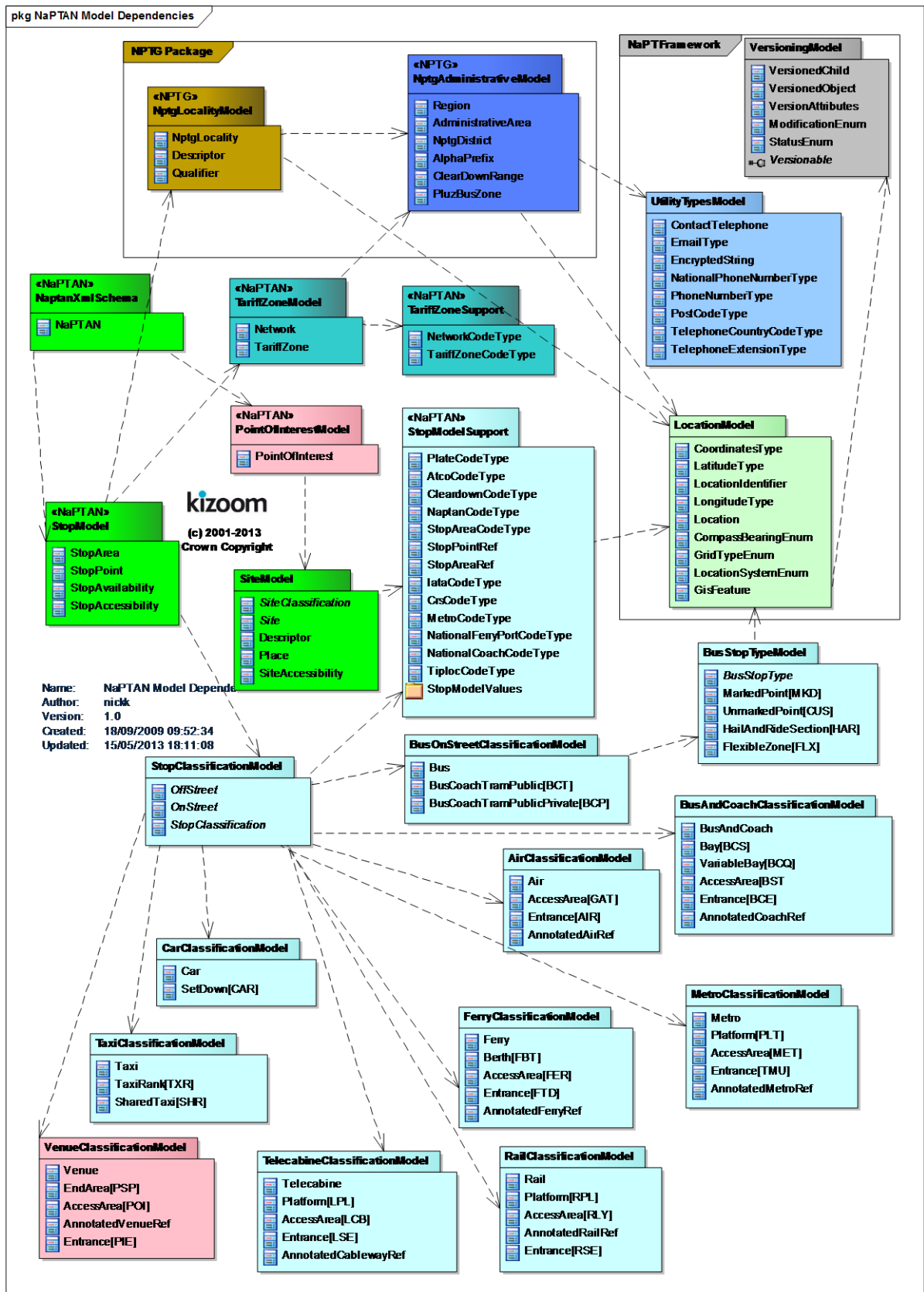

Figure 11-10 – NaPTAN Model Dependencies

The schemas are organised according to package group (see Table 11-6). NPTG and NaPTAN schemas are placed in the root folder; prerequisite shared schemas are placed in subfolders (\apd and \napt).

	folder	Schemas	Contents	
NaPTAN	root	NaPTAN.xsd	Terminal schema for NaPTAN.	Renamed in 2.0.
NPTG	root	NPTG.xsd	Terminal schema for NPTG use.	New in 2.0.
NPTG Discovery	root	NPTG_discovery.xsd	Terminal schema for NPTG discovery use.	New in 2.0.
<i>NPTG</i>	\nptg	NaPT_administrative_support-vN.N.xsd	Base data types for NPTG administration model	Modularised in 2.4
	\nptg	NaPT_administrative -vN.N.xsd	NPTG administrative model	Modularised in 2.4
	\nptg	NaPT_locality_support-vN.N.xsd	Base data types for NPTG locality model	Modularised in 2.4
	\nptg	NaPT_locality -vN.N.xsd	NPTG locality model	Modularised in 2.4
	\nptg	NaPT_discovery_adjacentPoints-vN.N.xsd	NPTG discovery adjacent region model	Modularised in 2.4
	\nptg	NaPT_discovery_applications-vN.N.xsd	NPTG discovery application model	Modularised in 2.4
<i>NaPT</i>	\napt	NaPT_accessibility-vN.N.xsd	Stop accessibility types.	New in 2.5
	\napt	NaPT_dates-vN.N.xsd	Date and time period type declarations shared with other NaPT schema.	New in 2.0.
	\napt	NaPT_dayTypes-vN.N.xsd	Common day types shared with other NaPT schema.	Modularised in 2.4
	\napt	NaPT_location-vN.N.xsd	Geographic type declarations shared with other NaPT schema.	New in 2.0.
	\napt	NaPT_modes-vN.N.xsd	Vehicle mode type declarations shared with other NaPT schema.	Modularised in 2.4
	\napt	NaPT_operator_support-vN.N.xsd	Vehicle mode type declarations shared with other NaPT schema.	Modularised in 2.4
	\napt	NaPT_stopAccessibility-vN.N.xsd	Stop accessibility definitions	New in 2.5
	\napt	NaPT_utility_types-vN.N.xsd	Low level application Type declarations shared with other NaPT schema.	Modularised in 2.4
	\napt	NaPT_utility_xml-vN.N.xsd	Common low level xml types shared with other NaPT schema.	Modularised in 2.4
	\napt	NaPT_versioningAttributes-vN.N.xsd	Common versioning types shared with other NaPT schema.	Modularised in 2.4
<i>NaPTAN</i>	\napt	NaPT_stop-vN.N.xsd	NaPTAN Stop model shared with other NaPT schema.	Modularised in 2.4
	\napt	NaPT_stopArea-vN.N.xsd	NaPTAN Stop Area model shared with other NaPT schema.	Modularised in 2.4
	\napt	NaPT_tariffZone-vN.N.xsd	NaPTAN TariffZone model shared with other NaPT schema.	New in 2.5
<i>Apd (Govtalk)</i>	\apd	AddressTypes-v1-3.xsd	UK address types.	Referenced in 2.0
	\apd	CommonSimpleTypes.xsd	UK simple types.	Referenced in 2.0
<i>W3C</i>	\xml	XML.xsd	Standard definitions of types.	Referenced in 2.0

Table 11-6 – NaPTAN 2.0 Module Names

12 RELATION TO OTHER STANDARDS

12.1 Transmodel Compliance

12.1.1 Transmodel Terminology

NaPTAN is based on *Transmodel*, a general abstract model for describing public transport information systems and uses *Transmodel* terminology where possible. *NaPTAN*'s model of interchange points precedes work to extend *Transmodel* to describe physical interchanges – IFOPT (Identification of Fixed Objects in Public Transport). A straightforward conceptual equivalence between *NaPTAN* and the IFOPT model can be established.

In *Transmodel*, a SCHEDULED STOP POINT is a point of access to transport identified in a timetable. IFOPT refines *Transmodel* 5.1 to add a physical model that describes a distinct model of the interchange (note, however, that although the physical interchange is in reality a different concept, in practice often it will have the same identifier as the SCHEDULED STOP POINT). The IFOPT model comprises a STOP PLACE and its physical components: a QUAY (any point of access to transport such as a platform), an ACCESS SPACE (an area within an interchange other than a QUAY, similar to a *NaPTAN* AccessArea) and an ENTRANCE (similar to a *NaPTAN* entrance)

The equivalences between some key *NaPTAN* elements and their corresponding *Transmodel* concepts are shown in *Table 12-1*.

<i>Transmodel/IFOPT</i>	<i>NPTG and NaPTAN v2.x</i>	<i>Previously NaPTAN v1.x</i>
ACTIVITY	Activity	
DIRECTION	Direction	JourneyDirection
LOCATION	Location	(Geocode)
LOCATING SYSTEM	LocatingSystem	--
STOP PLACE	Stop Area	
QUAY (SCHEDULED STOP POINT)	StopPoint : Platform, On street stop, Berth, Gateway, etc	Stop
ACCESS SPACE	StopPoint: AccessArea	
ENTRANCE	StopPoint: Entrance	
STOP AREA	StopArea	StopCluster
TIMING POINT	StopPoint with a timing status	
TARIFF ZONE	PlusbusZone, TariffZone	--
NETWORK	Network	

Table 12-1 – Comparison of Key Transmodel Terms

Most *NaPTAN* stop types (on-street bus and trolley stops, off-street platforms, berths, airport gates, taxi ranks, etc) are QUAYs. Note however that *NaPTAN* also includes station Entrances and AccessArea nodes of an interchange as stop points – In IFOPT these are distinguished as separate object types (but they are all Stop Place Components).

12.2 ITSO Interoperability

NaPTAN identifiers may be used as stop identifiers in ITSO conformant cards in either of two formats:

- the 12 byte **AtcoCode**
- the 8 character **NaPTANCode**: this will be stored in 4 bytes using the numeric form for each character,

13 NATIONAL LANGUAGE SUPPORT

NaPTAN is enabled to allow the coding of schemas in different National Languages, such as Welsh.

13.1 Text Content Types

The textual data of a NaPTAN document falls into three different categories:

- **Structured Text:** National Language translations of fixed encoded NaPTAN values, and terminology, for example 'Stop', 'Locality', 'Principal timing point'.
- **Free Text:** The contents of data elements that can be specified as text, for example area names, locality names and stop notes.
- **Aliased Free Text:** For certain entities, the use of alternate names is explicitly modelled in the schema. For example, a stop point can have a common name and several alternative names, allowing for bilingualism.

13.1.1 Use of Structured Text

An overall **xml:lang** attribute is specified at the schema level. This specifies the default language for the data, i.e. the default implied language that is to be used to publish the data. It defaults to English (en). Welsh is indicated by (cy)

- Translations are established for the different fixed elements.

13.1.2 Use of Free Text

Elements which may contain free text in a natural language (*Table 13-1*), such as Welsh or English, are typed **NaturalLanguageString** and have an **xml:lang** language attribute to indicate the language of the text.

- English is assumed if no attribute is specified.
- The provision of alternative names for a stop in different languages is covered by NaPTAN, which allows for multiple alternative names.
- Note that although the schema imposes no limit on the length of names, the NaPTAN database currently restricts names to a maximum of 48 characters.

13.1.3 Use of Aliased Free Text

Entities which are *aliased* may in effect have names in a number of different languages, as they allow multiple instances of a name subelement, each having an **xml:lang** language attribute to indicate the language in which it is expressed. Thus for example a stop might have its default name in Welsh, with an alternative in English.

- English is assumed if no **xml:lang** attribute is specified.

	Group	Element	Alias	NaPTAN Database length limit	Aliases in Version
NPTG	NptgLocality	Name	AlternativeDescriptor/ Name	48	2.x
	NptgDistrict	Name	No	48	
	Region	Name	No	48	
	CallCentre	Name	No	48	
	AdministrativeArea	Name	No	48	
NaPTAN	StopPoint	Descriptor / CommonName	AlternativeDescriptor / CommonName	48	1.x
		Descriptor / ShortName	AlternativeDescriptor / ShortName		2.x0
		Descriptor / Indicator	AlternativeDescriptor / Indicator	48	2.x
		Descriptor / Landmark	AlternativeDescriptor / Landmark	48	2.x
		Descriptor / Street	AlternativeDescriptor / Street	48	2.x
		Place / Suburb	No	48	
		Place / Town	No	48	
	Note	No	*		
	StopArea	Name	No	48	
	Network	Name	No		2.5
	Network	ShortName	No		2.5

	<i>TariffZone</i>	<i>Name</i>	No		2.5
	<i>TariffZone</i>	<i>ShortName</i>	No		2.5

Table 13-1 – Elements That May Contain Natural Language Free Text

14 INTEGRITY RULES

This section describes the integrity checks that should be applied to *NPTG* and *NaPTAN* data. For each schema these are divided in Syntactic and Semantic rules.

- **Syntactic Rules:** XML's inbuilt mechanisms, including *Keyrefs*, are used in the *NPTG* and *NaPTAN* schemas to enforce a number of basic integrity checks of data within *NPTG* and *NaPTAN* documents, including enforcing uniqueness. A document must satisfy these constraints, or it is not well formed and will not be processed further by applications.
 - Data types are specified for dates, times, durations and other common data types.
 - Restricted values are enforced by enumerations – see individual tables of allowed values under the schema guide entry for constrained elements.
 - Some additional rules for encoding formatted elements are enforced by regular expressions.
- **Semantic Rules:** Additional integrity rules that apply to interpreting *NPTG* & *NPTG* XML documents. These rules need to be applied by applications parsing a *NPTG* document. These are subdivided into two categories:
 - *Intrinsic Constraints (Int)* – Consistency checks that can be applied without reference to external data. For many of these, a sensible recovery action can be taken.
 - *Extrinsic Constraints (Ext)* – Checks of data values that require reference to an external source. Whether these need to be applied depends on the availability of the relevant data sets, and the purpose of the application

Semantic rules are assigned a severity (see *Table 14-1*) that indicates the likely action that an application (such as the *TransXChange Publisher*) will take if the rule is not satisfied.

Severity	Meaning	Action
1	Fundamental Inconsistency – Schedule cannot be interpreted. accurately	Report as serious error. Reject for registration.
2	Inconsistency – Default Remedial action possible, but statutory Registration requires clarification.	Report, apply remedy automatically. Reject for registration.
3	Inconsistency – Default Remedial action possible.	Report, apply remedy automatically.
4	Data reference does not exist in external source.	Report as missing.
5	Ancillary data reference does not exist.	Report as missing.
6	Minor data inconsistency.	Report, leave uncorrected.

Table 14-1 – Severity Codes for Semantic Integrity Rules

14.1 NPTG Integrity Rules

14.1.1 Syntactic Integrity Rules

Table 14-2 shows XML enforced integrity checks of data within a *NPTG* document, including uniqueness.

Group	Element	#	Scope	Reference
Code Scope	RegionCode	C1	Codes of Region declarations must be unique within NPTG document (& NPTG database).	RegionRef instances must reference a valid definition of a Region .
	AdministrativeArea-Code	C2	Codes of AdministrativeArea declarations must be unique within NPTG document (& NPTG database).	AdministrativeAreaRef instances must reference a valid definition of an AdministrativeArea .
	NptgDistrict	C3	Codes of NptgDistrict declarations must be unique within NPTG document. (& NPTG database).	NptgDistrictRef instances must reference a valid definition of an NptgLocality .
	NptgLocality	C4	Codes of NptgLocality declarations must be unique within NPTG document (& NPTG database).	NptgLocalityRef instances must reference a valid definition of an NptgLocality

	PlusbusZone		Codes of PlusbusZone declarations must be unique within NPTG document (& NPTG database).	
	AlternativeName / Name	N1	Alternative Names for a given element must be unique for parent element	
Cyclic	ParentLocalityRef	X1	NptgLocality must not reference itself.	

Table 14-2 – NPTG Syntactic Integrity Rules

14.1.2 Semantic Integrity Rules

Table 14-5 shows additional integrity rules that apply to interpreting NPTG XML documents. These rules need to be applied by applications parsing a NPTG document.

Group	#	Rule Name	Description			Recommended Error Handling
Transitive relationships	X2	ParentLocalityRef	NptgLocality 'Is part of' relationship should not be cyclic.	Ext	2	Ignore
Name uniqueness	M1	Region name uniqueness	Region names should be unique within NPTG.	Ext	2	
	M2	AdministrativeArea name uniqueness	AdministrativeArea names should be unique within NPTG.	Ext	2	
	M3	AdministrativeArea / ShortName uniqueness	Full qualified AdministrativeArea short names should be unique within NPTG.	Ext	2	
	M4	NptgDistrict name uniqueness	NptgDistrict names should be unique within NPTG.	Ext	2	
	M5	Qualified Locality / Name uniqueness	Full qualified Locality names should be unique within NPTG.	Ext	2	

Table 14-3 – NPTG Semantic Integrity Rules

14.2 NPTG Discovery Integrity Rules

14.2.1 Syntactic Integrity Rules

Table 14-4 shows XML enforced integrity checks of data within a NPTG Discovery document, including uniqueness.

Group	Element	#	Scope	Reference
Code Scope	WebApplication	C1	Codes of WebApplication declarations must be unique within NPTG document	WebApplication Ref instances must reference a valid definition of a WebApplication .
	CallCentreCode		Codes of CallCentre declarations must be unique within NPTG document. (& NPTG database).	CallCentre Ref instances must reference a valid definition of a CallCentre .

Table 14-4 – NPTG Discovery Syntactic Integrity Rules

14.2.2 Semantic Integrity Rules

Table 14-5 shows additional integrity rules that apply to interpreting NPTG Discovery XML documents. These rules need to be applied by applications parsing a NPTG document.

Group	#	Rule Name	Description	Cat	Sev	Recommended Error Handling
References	R1	RegionRef	Region Instances referenced through a RegionRef must exist in NPTG database.	Ext	2	reject
	R2	NptgLocalityRef	NptgLocality Instances	Ext	2	report

			referenced through an NptgLocalityRef must exist in the NPTG database.			
	R3	AdministrativeAreaRef	AdministrativeArea Instances referenced through an AdministrativeAreaRef must exist in NPTG database.	Ext	2	report
	R4	StopPointRef	StopPoint Instances referenced through a StopPointRef (for example from an AdjacentRegionPoint) must exist in NaPTAN database.	Ext	2	report

Table 14-5 – NPTG Discovery Semantic Integrity Rules

14.3 NaPTAN Integrity Rules

14.3.1 Syntactic Integrity Rules

Table 14-6 shows XML enforced integrity checks of data within a NaPTAN document, including uniqueness.

Group	Element	#	Scope	Reference
Versions	VersionNumber	V1	Version number of child should not be greater than that of parent element.	
	ModificationDate	V2	ModificationDate of child should not be later than that of parent	
Code Scope	AtcoCode	C1	Codes of StopPoint declarations must be unique within NaPTAN document.	
	StopAreaCode	C2	Codes of StopArea (Cluster) declarations must be unique within NaPTAN document.	
	Network	C3	Codes of Network (Fare scheme) declarations must be unique within NaPTAN document.	+NaPT v2.5
	TariffZone	C4	Codes of TariffZone (Fare zone) declarations must be unique within NaPTAN document.	+NaPT v2.5
	PointOfInterest	C4	Codes of PointOfInterest declarations must be unique within NaPTAN document.	+NaPT v2.5
Cross reference	StopAreaRef	R1	References by a Stop to a StopArea must correspond to a StopArea declared within the same NaPTAN document.	
	TariffZoneRef	R2	References by a Stop to a TariffZone (Fare zone) must correspond to TariffZone declared within the same NaPTAN document.	+NaPT v2.5
	AlternativeName / Name	N1	Alternative Names for a given element must be unique	
Cyclic	StopAreaParentRef	X1	StopArea must not reference itself through a StopAreaParentRef , either directly or indirectly. See also X2 for indirect references.	
Single reference	StopArea Unique Reference	U1	StopArea must only be referenced by a given StopPoint once.	
	NptgLocality Unique Reference	U2	StopPoint must only reference a given	

			NptgLocality through an Alternative / NptgLocalityRef once.	
--	--	--	---	--

Table 14-6 – NaPTAN Syntactic Integrity Rules

14.3.2 Semantic Integrity Rules

Transitive relationships	X2	ParentLocalityRef	NptgLocality 'Is part of' relationship should not be cyclic.	Ext	2	Ignore
---------------------------------	----	--------------------------	---	-----	---	--------

Table 14-7 shows additional integrity rules that apply to interpreting NaPTAN XML documents. These rules need to be applied by applications parsing NaPTAN documents.

Group	#	Rule Name	Description	Cat	Sev	Recommended Error Handling
NPTG refs	T3	NPTG Localities	NPTG Localities referenced by StopPoint and StopArea instances through an NptgLocalityRef must exist in NPTG database.	Ext	1	Reject
	T4	NPTG Administrative Areas	NPTG Administrative Areas referenced by StopPoint and StopArea instances through an AdministrativeAreaRef must exist in NPTG database.	Ext	1	Reject
	T5	NPTG PlusbusZones	NPTG Plusbus zones referenced by StopPoint instances through a PlusbusZoneRef must exist in NPTG database.	Ext	4	Report
	S1	NPTG Locality Status	NPTG Localities referenced by active StopPoint and StopArea instances through an NptgLocalityRef or Alternative reference should be active.	Ext	3	Report
	S2	NPTG Administrative Area Status	NPTG Administrative Areas referenced by active StopPoint and StopArea instances through an AdministrativeAreaRef should be active.	Ext	3	Report
	S3	NPTG Plusbus Status	Plusbus zones referenced by active StopPoint instances through a PlusbusZoneRef should be active.	Ext	4	Report, Ignore link
NaPTAN	N1	NaPTAN Stop Identifiers.	Stops defined as new should not exist in NaPTAN database, or be defined locally	Ext	6	Report
			Stops defined as revised should exist in NaPTAN database, or be defined locally	Ext	6	Report
	N2	NaPTAN Stop Area Identifiers.	StopArea instances referenced by a StopPoint / StopAreaRef in a document must either exist in NaPTAN database or be defined in document.	Ext	3	Ignore
	N4	NaPTAN Stop types	StopType value should correspond to OnStreet or OffStreet subtype.	Int	3	Use OnStreet or OffStreet element in preference
	N3	ShortCommonName length.	StopPoint / ShortCommonName should not exceed limit set by and for Administrative Area	Int	3	Truncate & Report
	N4	Qualified CommonName uniqueness	Full qualified stop names should be unique with Name within national context	Ext	4	Report
	X2	Stop Area hierarchy	Stop area hierarchy relationship should not be cyclic. StopArea referenced by StopArea / ParentRef should not be parent or	Ext	3	Report, ignore

			ancestor of StopArea . See also X1 for self-references.			
S5	<i>NaPTAN</i> Stop Point StopArea Status		<i>NaPTAN</i> Stop Areas referenced by active StopPoint instances through a StopAreaRef should be active.	Ext	4	Report
S6	<i>NaPTAN</i> StopArea parent Status		<i>Parent</i> Stop Areas referenced by active StopArea instances through a StopArea / ParentRef should be active.	Ext	4	Report
E3	TiplocCode		TiplocCode of AnnotatedRailRef should be valid TIPLOC.	Ext	4	Report
E4	CoachCode		CoachCode of AnnotatedCoachRef should be valid National Coach code.	Ext	4	Report
E5	IataCode		IataCode of AnnotatedAirRef declarations should be valid IATA airport code.	Ext	4	Report
E6	FerryCode		FerryCode of AnnotatedFerryRef declarations should be valid ferry port airport code.	Ext	4	Report

Table 14-7 – NaPTAN Semantic Integrity Rules

15 APPENDICES

15.1 2.0 Changes Since 1.1

The following table summarises the changes to *NaPTAN* included in Version 2.0, compared with Version 1.0:

- Addition of *NPTG* elements to a new schema.
- [NaPTAN good practice] Use of **AlternativeName** rather than whole element.
- Renamed **ATCOCode**→**AtcoCode**,
 - **Stop** → **StopPoint**,
 - **StopRef**→**StopPointRef**,
 - **StopGroup**→ **StopArea**.
 - **SMSNumber**→**NaptanCode**,
 - **AreaCode** → **StopAreaCode**,
 - **AreaType**→**StopAreaType**,
 - **BusRegistrationStatus**→**TimingStatus**
- [NaPTAN Transmodel] Renamed **Stop/Place/Direction** to be **Bearing** to avoid confusion with the direction of a vehicle journey.
- [NaPTAN] Renamed **Locality** element to be **Place**, to be **Transmodel** compliant, and to avoid confusion with **NptgLocality**, and **Location**.
- [NPTG modularisation] Moved **StopPoint** and **StopArea** structures to NaPT schema.
- [NAPT harmonisation] **Suburb, Town, Street** made **Natural Language Types**
- [NPTG harmonisation] Move NPTG **AdministrativeAreaCode** type to individual stop points. Add **AdministrativeAreaRef** to **StopPoint** and **StopArea**.
- [NaPTAN harmonisation] Added optional **CreationDateTime**, and standardised **ModificationDateTime** to modification details group attributes. Added to additional entities.
- [NAPT geographic] Add WGS geocode support. WGS84 types added to NaPT geographic. Added **LocationSystem** attribute to schema root. Modify **Location** to support both.
- [NPTG modularisation] Moved **Country** from **AdministrativeArea** to **Region**. Note also that each **AdministrativeArea** must belong to a region, so this means a national region will be required to support national **AdministrativeArea**.
- [NPTG modularisation] Add **AdministrativeArea** to **NptgDistrict**.
- [NaPTAN modularisation] Moved **Location** element to be within **Place**.
- [NPTG] Model **WebApplication** as separate element classifications.
- [NPTG] Move **ExchangePoints** to NaPTAN.
- [NPTG Discovery] Move Call centres, Region and AREPS. [NPTG Discovery]
- [NPTG] Add SMS prefixes to **AdministrativeArea**.
- [NPTG] Add **ShortName** to **AdministrativeArea**.
- [NaPTAN] Add FLX **BusStopType**, add CCH **StopType**.
- [NaPTAN] Group **CommonName, Street, Indicator, Landmark** within a **Descriptor** Element.
- [NaPTAN] Rename and extend **StopPoint AlternativeName** to be **AlternativeDescriptor**, with **CommonName, Street, Indicator, and Landmark**.
- [NaPTAN] Add **ShortCommonName** to **StopPoint / Descriptor**. Add **MaximumLengthForShortNames** to **AdministrativeArea**
- [NPTG] Add Plusbus zones.
-

CSV Renamed fields to match XML schema element names
CSV add fields for additional elements, including lang & mod types
CSV Reorganise

15.2 2.1 Changes Since 2.0

The following table summarises the changes to *NaPTAN* included in Version 2.1, compared with Version 2.0:

- NaPT_stop **Landmark** and **Street** elements made .optional.
- NaPT_stop **AnnotatedStopRef** supported on **OnStreet/Bus**
- NaPT_stop **OperatorRef** added to **AnnotatedStopRef**.

15.3 References

15.3.1.1 Transport Domain

TransXChange

TransXChange is a UK Department for Transport sponsored protocol, which defines a national data standard for the interchange of bus route registration, route and timetable information between operators, the Traffic Area Offices, Local Authorities and Passenger Transport Executives, and Traveline – the National Passenger Transport Information System.

<http://www.transxchange.dft.gov.uk/>

	TransXChange XML Schema 2.5 (http://www.transxchange.dft.gov.uk/)	2013 April	Nick Knowles
	Department for Transport TransXChange Schema Guide 2.5 http://www.transxchange.org.uk/	2013 April	Nick Knowles

NaPTAN

National Public Transport Access Nodes (*NaPTAN*) Database. *NaPTAN* seeks to assemble and maintain a single source of information on the location and naming of bus stops and other public transport access nodes in England, Wales and Scotland. <http://www.traveline.org.uk/naptan/>

	UK Department for Transport Integrated Transport CREATING THE JOURNEYWEB NETWORK Deliverable Number 04-5 NaPTAN Specification v1.0 National Public Transport Access Nodes (NaPTAN) Database http://www.traveline.org.uk/naptan/naptan-4.5-Specification-v1.0b97.doc	2002 Nov	WS Atkins
	PROJECT 783, TRANSPORT DIRECT NAPTAN HOSTING, NAPTAN - UPLOADING DATA P78324003 Issue 1 Draft A	28 October 2003	Thales

15.3.2 JourneyWeb

JourneyWeb is a UK Department for Transport sponsored protocol which defines a national data standard for the dynamic interchange of transport information, including journey plans, and timetables. It is used by the Transport Direct Portal project.

JW	UK Department for Transport JourneyWeb 2.5 Schema GUIDE http://www.kizoom.com/standards/journeyweb/schema/schemas.htm	2013 April	Kizoom
----	---	------------	--------

Transmodel CEN TC 278

Transmodel is a European Union sponsored abstract standard for describing Public Transport Information Systems.

Transmodel	French Ministry for Transport REFERENCE DATA MODEL FOR PUBLIC TRANSPORT [CEN01] CEN TC278, Reference Data Model For Public Transport, ENV12896 revised, June 2001.	2004 Jan	CEN
------------	--	----------	-----

	[CEN97] CEN TC278, Road Transport and Traffic Telematics - Public Transport -Reference Data Model, prENV 12896, May 1997 http://www.Transmodel.org		
IFOPT	Road traffic and transport telematics — Public transport — Identification of fixed objects in public transport CEN/TC 278 CEN TC 278 WI 00278207	2007 Dec	CEN

SIRI CEN TC 278

SIRI	Public transport — Service interface for real-time information relating to public transport operations — Part 1: Context & Framework: CEN/TS 00278181-1, — Part 2: Communications Infrastructure CEN/TS 00278181-2, — Part 3: Functional service interfaces: CEN/TS 00278181-3	2008 Jan 2012 V 2.0	CEN
------	---	------------------------	-----

15.3.2.2 Software & General

XML Schema

<http://www.w3.org/XML/Schema>

	XML Schema Part 0: Primer http://www.w3.org/TR/2001/REC-xmlschema-0-20010502/	2001 May 2	David C. Fallside
	XML Schema Part 1: Structures http://www.w3.org/TR/2001/REC-xmlschema-1-20010502/	2001 May 2	Various
	XML Schema Part 2: Datatypes http://www.w3.org/TR/2001/REC-xmlschema-2-20010502/	2001 May 2	Paul V. Biron and Ashok Malhotra

ISO Time Formats

	D ISO 8601 Date and Time Formats http://www.w3.org/TR/xmlschema-2/ - isoformats	2001 May 2	W3C Various
	ISO8601:2000(E) Data elements and interchange formats – Information interchange – Representation of dates and times Second edition 2000-12-15 http://lists.ebxml.org/archives/ebxml-core/200104/pdf00005.pdf	2000 Dec 15	Louis Visser

WGS 1984 Location Referencing

	World Geodetic Standard 1984 http://www.wgs84.com/		W3C Various
--	---	--	-------------

ISO 639-1 Names of Languages

	ISO 639-1:2001. Code for the representation of the names of languages http://www.oasis-open.org/cover/iso639a.html		Infoterm
--	--	--	----------

Rfc 1766 Tags for the Identification of Languages

	rfc1766 – Tags for the Identification of Languages http://www.ietf.org/rfc/rfc1766.txt		Infoterm
--	---	--	----------

GovTalk XML Coding Standards

	Office of the e-Envoy Schema Guidelines Best Practice Advice Version 2 http://www.govtalk.gov.uk/documents/Schema Guidelines 2.doc	2002 Oct 12	Paul Spencer
	e-Government Metadata Standard e-GMS 1.0 http://www.govtalk.gov.uk/documents/e-Government Metadata Standard v1.pdf	2002 Apr	Office of e-Envoy

15.4 Standard Abbreviations for Topographical Features

The following standard abbreviations for topographical features and other terms are preferred. They should be used only where it is essential that the full name be abbreviated (to meet constraints of field-lengths in a database, for instance).

15.4.1 Terms for Relationship

Relationship	Abbreviation
Adjacent	Adj
Near	Nr
Opposite	Opp
Outside	O/s
Great	Gt

Greater	Gtr
Little	Lt
Upper	Upr
Middle	Mdl
Lower	Lwr
East	E

West	W
North	N
South	S
Saint	St (1)

15.4.2 Topographical Features

Topographical Feature	Abbreviation
Alley	Al
Approach	App
Arcade	Arc
Avenue	Ave, Av
Back	Bk
Boulevard	Bvd
Bridge	Bri
Broadway	Bway
Buildings	Bldgs
Bungalows	Bglws
Business	Bsns
Causeway	Cswy
Centre	Ctr
Church	Chu, Ch
Churchyard	Chyd
Circle	Circ
Circus	Ccus
Close	Clo, Cl
College	Col
Common	Comn
Corner	Cnr
Cottages	Cotts
Court	Ct
Courtyard	Ctyd

Crescent	Cres
Cross-roads	Xrds
Drive	Dri, Dr
Drove	Dro
Embankment	Embkmt
Esplanade	Espl
Estate	Est
Gardens	Gdns
Gate	Ga
Green	Grn, Gn
Grove	Gro
Heights	Hts
Hospital	Hosp
Industrial	Ind
Infirmary	Inf
Interchange	Intc
Junction	Jct
Lane	Ln, La
Manor	Mnr
Mansions	Mans
Market	Mkt
Mews	Mws
Mosque	Msq
Mount	Mt
Orchard	Orch
Palace	Pal
Parade	Pde

Park	Pk
Passage	Pass
Place	Pl
Police Station	Pol Stn
Precinct	Prec
Promenade	Prom
Quadrant	Quad
Road	Rd
Roundabout	Rdbt
Square	Sq
Stairs	Strs
Station	Stn
Steps	Stps
Street	St (1)
Subway	Sub
Synagogue	Syng
Terrace	Ter, Terr
Temple	Tmpl
Trading	Trdg
Turn	Tn
View	Vw
Villas	Vs
Walk	Wlk
Way	Wy
Yard	Yd

(1) St as prefix means 'Saint'. St as suffix means 'Street'.

15.4.3 Common Acronyms

Term	Abbreviation
Football Club	FC
Her Majesty's Prison	HMP

Post Office	PO
Public House	PH
Royal Air Force	RAF

--	--

15.4.4 Common Adjectives

Adjective	Abbreviation
National	Ntl

British	Brt
Royal	Ryl

Scottish	Sct
----------	-----

15.5 NPTG CSV Exchange Formats

This appendix describes the *NPTG* CSV exchange format. It presents:

- A diagram of the *NPTG* 1.2 tables and their interrelationships.
- A diagram of the revised *NPTG* 2.1 tables and their interrelationships.
- A list of the *NPTG* CSV table names.
- Detailed descriptions of the contents of each *NPTG* CSV table.

For comparison purposes, *Figure 15-1* shows the previous data fields and relationships between each of the CSV exchange tables in the *NPTG* for **Version 1.2**.

The following conventions are used:

- *NaPTAN* elements are shown shaded in green. For example, '*NaPTAN Point*'.
- Fields deprecated in 1.1 have a '-' against them. For example '*Exchange Point ID*'.
- Derived Fields are shown in brackets. For example, '*(Lon)*'
- Required fields are shown in bold.
- Primary keys are indicated by a PK. Foreign keys by a FK.

Figure 15-2 shows the data fields and relationships between each of the CSV exchange tables in the *NPTG* for **Version 2.1**

Figure 15-3 shows the data fields and relationships between each of the CSV exchange tables in the *NPTG Discovery* for **Version 2.1**; the tables have been partitioned between the two schemas and some tables have been moved to the *NaPTAN* schema.

The same conventions are used. In addition:

- *NPTG* 2.x schema element names are used as the field names.
- Fields added in 2.0 have a '+' against them. For example '*LocalityClassification+*'.
- Fields whose types have been revised have a * against them – this is restricted to revising *Date* to be a *DateTime*. Fields whose enums values are not marked.

Summary of differences

- RailExchange, CoachExchange, Air Exchange moved to NaPTAN as AnnotatedRailRef.
- CallCentre and Region Traveline URLs AREP moved to NPTG Discovery
- PlusbusZones added.
- Relationship between
- ShortName added,
- Entity modification attributes standardised.
- Language attributes added

15.5.1 NPTG CSV 1.2 CSV Format Overview [Deprecated]

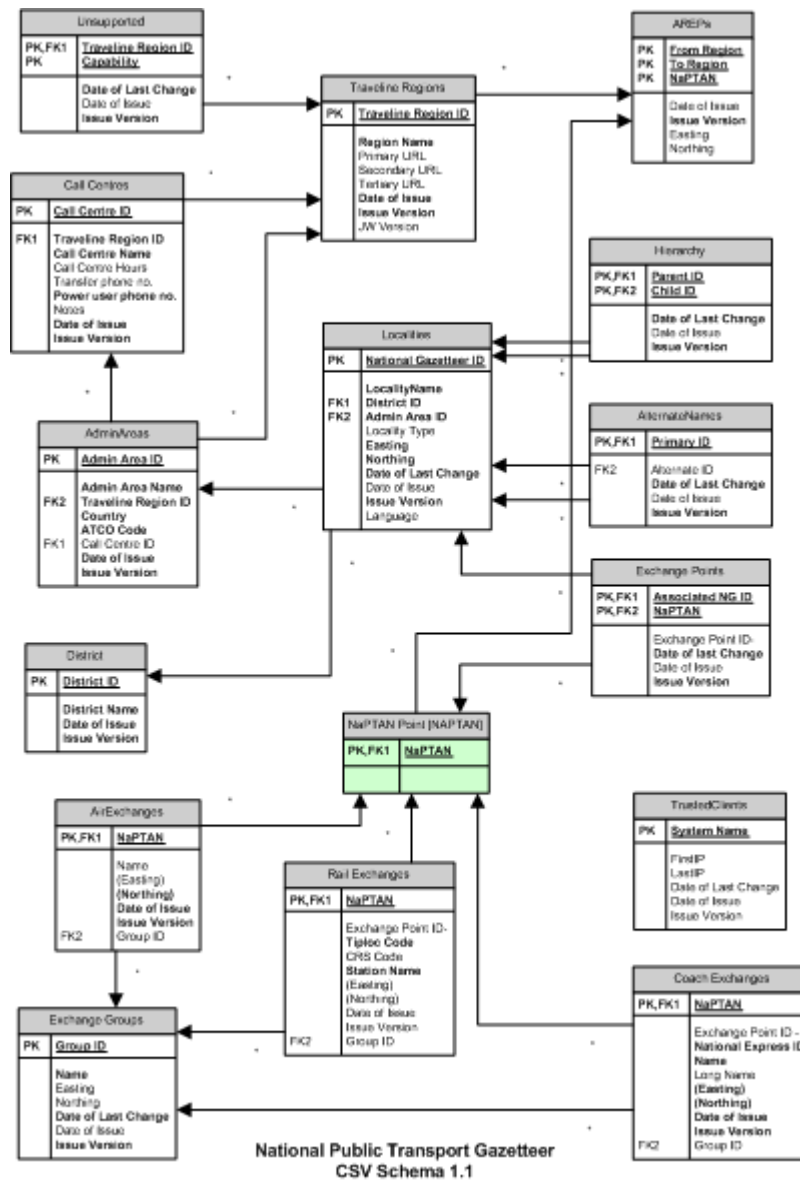

Figure 15-1 – Diagram of National Gazetteer 1.2 CSV Tables

15.5.2 NPTG CSV 2.1 CSV Format Overview

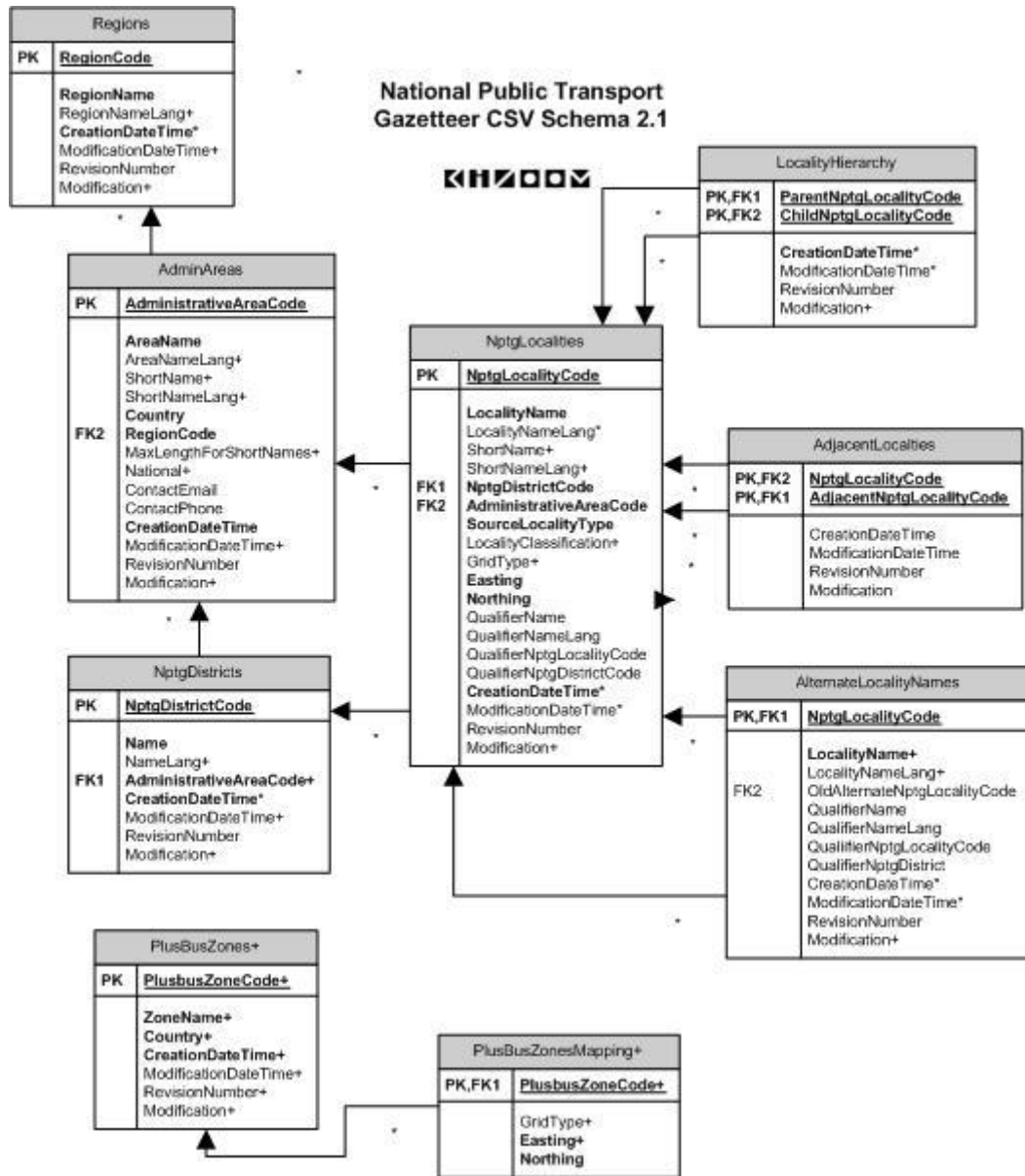

Figure 15-2 – Diagram of National Gazetteer 2.1 CSV Tables

15.5.3 NPTG Discovery CSV 2.1 CSV Format Overview

NPTG Discovery CSV Schema 2.1

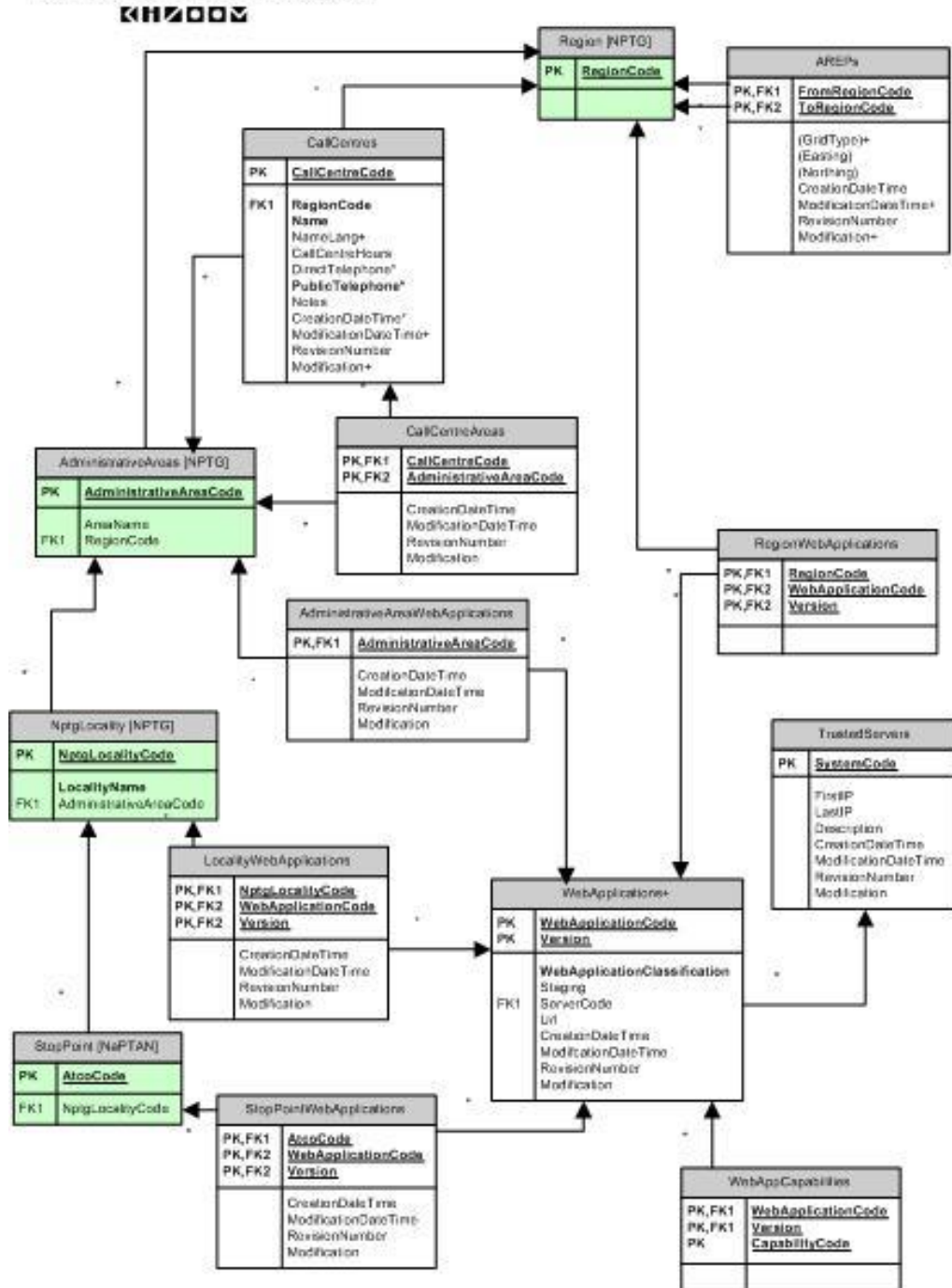

Figure 15-3 – Diagram NPTG Discovery CSV 2.1 CSV Tables

15.6 NPTG: CSV Files

	Group	Content	File name	Old File Name	Version
NPTG	Admin	Regions	Regions.csv	Traveline Regions.csv	1.0
		Administrative Areas	AdminAreas.csv	AdminAreas.csv	1.0
		NPTG Districts	Districts.csv	District.csv	1.0
	Locality	NPTG Localities	Localities.csv	Localities.csv	1.0

		Alternative Locality Names	LocalityAlternativeNames.csv	AlternateNames.csv	1.0
		Locality Hierarchy	LocalityHierarchy.csv	Hierarchy.csv	1.0
		Adjacent Localities	AdjacentLocality.csv	--	2.0+
		Plusbus	Plusbus zones	PlusbusZones.csv	--
		Plusbus zone boundaries	PlusbusMapping.csv	--	2.0+
NPTG Discovery	Exchange Resource	Adjacent Region Points	AREPs.csv	AREPs.csv	1.0
		Trusted Servers	TrustedServers.csv	TrustedClients.csv	1.0*
		Call Centres	CallCentres.csv	CallCentres.csv	1.0
		Call Centres Areas	CallCentresAreas.csv	CallCentresAreas.csv	2.0
		WebApplications	WebApplications.csv	(Regions.csv)	2.0+
		WebApplications for Region	RegionWebApplications.csv	--	2.0+
		WebApplications for Area	AdminAreaWebApplications.csv	--	2.0+
		WebApplications for Locality	LocalityWebApplications.csv	--	2.0+
		WebApplications for Stop	StopWebApplications.csv	--	2.0+

Table 15-1 – NPTG CSV files

Each CSV file must contain a header row containing the corresponding field names for each file. Some derived fields are only present in exports from the NaPTAN database. If these derived fields are included in data intended for import into the database they will simply be ignored.

15.6.1 NPTG: Regions CSV table

Parent Element	CSV Field /Element	Old CSV Field Name	Mandatory	Type	Size	V
Locality	RegionCode	Region ID	Yes	FK	8	1.0
Locality	RegionName	LocalityName	Derived	<i>nlString</i>	48	1.0
RegionName	RegionNameLang	<i>new</i>	No	<i>xml:language</i>	2	+2.0
Locality	CreationDateTime	Date of Issue	Yes	<i>xsd:dateTime</i>	25	1.0 *
Locality	ModificationDateTime	Date of Last Change	No	<i>xsd:dateTime</i>	25	1.0 *
Locality	RevisionNumber	Issue Version	No	<i>revision</i>	5	1.0 *
Locality	Modification	<i>new</i>	No	<i>new del rev</i>	3	+2.0

Table 15-2 – NPTG: Region.csv Content

15.6.2 NPTG: AdminAreas CSV table

Parent Element	CSV Field /Element	Old CSV Field Name	Mandatory	Type	Size	V
AdminArea	AdministrativeAreaCode	Admin Area ID	Yes	PK	8	1.0
AdminArea	AtcoAreaCode	Atco Code	Yes	<i>code</i>		+2.0
AdminArea	AreaName	LocalityName	Derived	<i>nlString</i>	48	1.0
AreaName	AreaNameLang	<i>new</i>	No	<i>xml:language</i>	2	+2.0
AdminArea	ShortName	<i>n new</i>	Derived	<i>nlString</i>	48	+2.0
AdminArea	ShortNameLang	<i>new</i>	No	<i>xml:language</i>	2	+2.0
AdminArea	Country	<i>same</i>	Yes	<i>enum</i>	3	1.0
AdminArea	RegionCode	Region ID	Yes	FK	8	1.0
AdminArea	MaximumLengthForShortNames		No	<i>xsd:positive-integer</i>	3	+2.0
AdminArea	National	<i>new</i>	No	<i>xsd:boolean</i>	1	+2.0
AdminArea	ContactEmail	Email for contact	No	<i>apd:email</i>	*	+2.0
AdminArea	ContactTelephone	PhoneNo for contact	No	<i>apd:phone</i>	20	+2.0
AdminArea	CreationDateTime	Date of Issue	Yes	<i>xsd:dateTime</i>	25	1.0 *
AdminArea	ModificationDateTime	Date of Last Change	No	<i>xsd:dateTime</i>	25	1.0 *
AdminArea	RevisionNumber	Issue Version	No	<i>revision</i>	5	1.0 *
AdminArea	Modification	<i>new</i>	No	<i>enum</i>	3	+2.0

Table 15-3 – NPTG: Admin.csv Content

Note: Administrative Area Cleardown Prefixes and NaptanCode prefixes may only be exchanged in XML

15.6.3 NPTG: District CSV table

Parent Element	CSV Field /Element	Old CSV Field Name	Mandatory	Type	Size	V
District	DistrictCode	District ID	Yes	PK	8	1.0
District	DistrictName	Name	Yes	PK	48	1.0

Parent Element	CSV Field /Element	Old CSV Field Name	Mandatory	Type	Size	V
DistrictName	DistrictLang	<i>new</i>	No	<i>xml:language</i>	2	+2.0
District	AdministrativeAreaCode	<i>new</i>	Yes	<i>FK</i>	8	+2.0
District	CreationDateTime	Date of Issue	No	<i>xsd:dateTime</i>	25	1.0 *
District	ModificationDateTime	Date of Last Change	No	<i>xsd:dateTime</i>	25	+2.0
District	RevisionNumber	Issue Version	No	<i>revision</i>	5	1.0 *
District	Modification	<i>new</i>	No	<i>enum</i>	3	+2.0

Table 15-4 – NPTG: District.csv Content

15.6.4 NPTG: Locality CSV table*

Parent Element	CSV Field /Element	Old CSV Field Name	Mandatory	Type	Size	V
Locality	NptgLocalityCode	NatGazID	Yes	PK	8	1.0
Locality	LocalityName	LocalityName	Yes	<i>placeName</i>	48	1.0
LocalityName	LocalityNameLang	<i>new</i>	No	<i>enum</i>	2	+2.0
Locality	ShortName	<i>new</i>	Derived	<i>placeName</i>	48	+2.0
ShortName	ShortNameLang	<i>new</i>	No	<i>xml:language</i>	2	+2.0
Locality	QualifierName	<i>new</i>	No	<i>placeName</i>	48	+2.0
QualifierName	QualifierNameLang	<i>new</i>	No	<i>xml:language</i>	2	+2.0
Locality	QualifierLocalityRef	<i>new</i>	No	FK	8	+2.0
Locality	QualifierDistrictRef	<i>new</i>	No	FK	8	+2.0
Locality	AdministrativeAreaCode	Admin Area ID	Yes	FK	8	1.0
Locality	NptgDistrictCode	District ID	Yes	FK	8	1.0
Locality	SourceLocalityType	LocalityType	Yes	<i>enum</i>	3	1.0
Location	GridType	<i>new</i>	No	<i>enum</i>	1	+2.0
Location	Easting	<i>same</i>	Yes	<i>easting</i>	6	1.0
Location	Northing	<i>same</i>	Yes	<i>northing</i>	7	1.0
Location	Longitude	<i>new</i>	Derived	<i>lon</i>		+2.0
Location	Latitude	<i>new</i>	Derived	<i>lat</i>		+2.0
Locality	CreationDateTime	Date of Issue	Yes	<i>xsd:dateTime</i>	25	1.0*
Locality	ModificationDateTime	Date of Last Change	No	<i>xsd:dateTime</i>	25	1.0 *
Locality	RevisionNumber	Issue Version	No	<i>revision</i>	5	1.0
Locality	Modification	<i>new</i>	No	<i>enum</i>	3	+2.0

Table 15-5 – NPTG: Localities.csv Content

15.6.5 NPTG: LocalityAlternativeNames CSV table*

Parent Element	CSV Field /Element	Old CSV Field Name	Mandatory	Type	Size	V
AltLocality	NptgLocalityCode	Parent ID	Yes	PK, FK	8	1.0
Locality	OldNptgLocalityCode-	Alternate ID	No	FK	8	--1.0
AltLocality	LocalityName	LocalityName	Yes	<i>placeName</i>	48	1.0
LocalityName	LocalityNameLang	<i>new</i>	No	<i>xml:language</i>	2	+2.0
AltLocality	ShortName	<i>new</i>	Derived	<i>placeName</i>	48	+2.0
AltLocality	ShortNameLang	<i>new</i>	No	<i>xml:language</i>	2	+2.0
AltLocality	QualifierName	<i>new</i>	No	<i>placeName</i>	48	+2.0
QualifierName	QualifierNameLang	<i>new</i>	No	<i>xml:language</i>	2	+2.0
AltLocality	QualifierLocalityRef	<i>new</i>	No	FK	8	+2.0
AltLocality	QualifierDistrictRef	<i>new</i>	No	FK	8	+2.0
AltLocality	CreationDateTime	Date of Issue	No	<i>xsd:dateTime</i>	25	1.0 *
AltLocality	ModificationDateTime	Date of Last Change	No	<i>xsd:dateTime</i>	25	1.0 *
AltLocality	RevisionNumber	Issue Version	No	<i>revision</i>	5	1.0 *
AltLocality	Modification	<i>new</i>	No	<i>enum</i>	3	+2.0

Table 15-6 – NPTG: LocalityAlternativeNames.csv Content

15.6.6 NPTG: LocalityHierarchy CSV table*

Parent Element	CSV Field /Element	Old CSV Field Name	Mandatory	Type	Size	
Hierarchy	ParentNptgLocalityCode	Parent ID	Yes	PK, FK	8	1.0
Hierarchy	ChildNptgLocalityCode	Child ID	Yes	PK, FK	8	1.0
Hierarchy	CreationDateTime	Date of Issue	Yes	<i>xsd:dateTime</i>	25	1.0 *
Hierarchy	ModificationDateTime	Date of Last Change	No	<i>xsd:dateTime</i>	25	1.0 *
Hierarchy	RevisionNumber	Issue Version	No	<i>revision</i>	5	1.0 *
Hierarchy	Modification	<i>new</i>	No	<i>enum</i>	3	+2.0

Table 15-7 – NPTG: LocalityHierarchy.csv Content

15.6.7 NPTG: AdjacentLocalities CSV table+

Parent Element	CSV Field /Element	Old CSV Field Name	Mandatory	Type	Size	
Locality	NptgLocalityCode	<i>new</i>	Yes	PK, FK	8	+2.0
Locality	AdjacentNptgLocalityCode	<i>new</i>	Yes	PK, FK	8	+2.0
Locality	CreationDateTime	<i>new</i>	Yes	<i>xsd:dateTime</i>	25	+2.0
Locality	ModificationDateTime	<i>new</i>	No	<i>xsd:dateTime</i>	25	+2.0
Locality	RevisionNumber	<i>new</i>	No	<i>revision</i>	5	+2.0
Locality	Modification	<i>new</i>	No	<i>enum</i>	3	+2.0

Table 15-8 – NPTG: AdjacentLocalities.csv Content

15.6.8 NPTG Plusbuszones CSV table+

Parent Element	CSV Field /Element	Old CSV Field Name	Mandatory	Type	Size	
PlusbusZone	PlusbusZoneCode	<i>new</i>	Yes	PK	12	+2.0
PlusbusZone	Name	<i>new</i>	Yes	<i>nlString</i>	48	+2.0
Name	NameLang	<i>new</i>	No	<i>xml:language</i>	2	+2.0
PlusbusZone	Country	<i>new</i>	Yes	<i>enum</i>	8	+2.0
PlusbusZone	CreationDateTime	<i>new</i>	Yes	<i>xsd:dateTime</i>	25	+2.0
PlusbusZone	ModificationDateTime	<i>new</i>	No	<i>xsd:dateTime</i>	25	+2.0
PlusbusZone	RevisionNumber	<i>new</i>	No	<i>revision</i>	5	+2.0
PlusbusZone	Modification	<i>new</i>	No	<i>enum</i>	3	+2.0

Table 15-9 – NPTG: PlusbusZones.csv Content

15.6.9 NPTG PlusbuszonesMapping CSV table+

Parent Element	CSV Field /Element	Old CSV Field Name	Mandatory	Type	Size	
Mapping	PlusbusZoneCode	<i>new</i>	Yes	PK	12	+2.0
Mapping	Sequence	<i>new</i>	Yes	<i>integer</i>	int	+2.0
Location	GridType	<i>new</i>	No	<i>enum</i>	1	+2.0
Location	Easting	<i>new</i>	Yes	<i>easting</i>	6	+2.0
Location	Northing	<i>new</i>	Yes	<i>northing</i>	7	+2.0
Mapping	CreationDateTime	<i>new</i>	Yes	<i>xsd:dateTime</i>	25	+2.0
Mapping	ModificationDateTime	<i>new</i>	No	<i>xsd:dateTime</i>	25	+2.0
Mapping	RevisionNumber	<i>new</i>	No	<i>revision</i>	5	+2.0
Mapping	Modification	<i>new</i>	No	<i>enum</i>	3	+2.0

Table 15-10 – NPTG: PlusbusMappings.csv Content

15.7 NPTG Discovery: CSV Files

15.7.1 NPTG Discovery: AdjacentRegionPoints CSV table+

Parent Element	CSV Field /Element	Old CSV Field Name	Mandatory	Type	Size	
Arep	AtcoCode	ATCOCode	Yes	PK	12	1.0

Parent Element	CSV Field /Element	Old CSV Field Name	Mandatory	Type	Size	
Arep	FromRegionCode		Yes	PK, FK	8	1.0
Arep	ToRegionCode		Yes	PK, FK	8	1.0
Location	(GridType)	<i>new</i>	No	enum	1	+2.0
Location	(Easting)	<i>same</i>	Yes	<i>easting</i>	6	1.0
Location	(Northing)	<i>same</i>	Yes	<i>northing</i>	7	1.0
Arep	CreationDateTime	Date of Issue	No	<i>xsd:dateTime</i>	25	1.0
Arep	ModificationDateTime	<i>new</i>	No	<i>xsd:dateTime</i>	25	+2.0
Arep	RevisionNumber	Issue Version	No	<i>revision</i>	5	1.0
Arep	Modification	<i>new</i>	No	enum	3	+2.0

Table 15-11 – NPTG: AdjacentRegionPoints.csv Content

15.7.2 NPTG Discovery: CallCentres CSV table+

Parent Element	CSV Field /Element	Old CSV Field Name	Mandatory	Type	Size	
CallCentre	CallCentreCode	ATCOCode	Yes	PK	12	1.0
CallCentre	RegionCode		Yes	PK, FK	8	1.0
CallCentre	Name		Yes	<i>n1String</i>	48	+2.0
Name	NameLang	<i>new</i>	No	<i>xml:language</i>	2	+2.0
CallCentre	PublicTelephone	<i>new</i>	Yes	<i>phone</i>	18	+2.0
CallCentre	DirectTelephone	<i>same</i>	No	<i>phone</i>	18	1.0
CallCentre	Notes	<i>new</i>	No	<i>xsd:string</i>	3	+2.0
CallCentre	CreationDateTime	Date of Issue	No	<i>xsd:dateTime</i>	25	1.0
CallCentre	ModificationDateTime	<i>new</i>	No	<i>xsd:dateTime</i>	25	+2.0
CallCentre	RevisionNumber	Issue Version	No	<i>revision</i>	5	1.0
CallCentre	Modification	<i>new</i>	No	enum	3	+2.0

Table 15-12 – NPTG: CallCentres.csv Content

Call centre availability / opening hours can only be exchanged in XML

15.7.3 NPTG Discovery: CallCentresAreas CSV table+

Parent Element	CSV Field /Element	Old CSV Field Name	Mandatory	Type	Size	
CallCentreArea	CallCentreCode	<i>new</i>	Yes	PK	12	1.0
CallCentreArea	AdministrativeAreaCode	<i>new</i>	Yes	PK, FK	8	1.0
CallCentreArea	CreationDateTime	<i>new</i>	No	<i>xsd:dateTime</i>	25	1.0
CallCentreArea	ModificationDateTime	<i>new</i>	No	<i>xsd:dateTime</i>	25	+2.0
CallCentreArea	RevisionNumber	<i>new</i>	No	<i>revision</i>	5	1.0
CallCentreArea	Modification	<i>new</i>	No	enum	3	+2.0

Table 15-13 – NPTG: CallCentres.csv Content

15.7.4 NPTG Discovery: TrustedServer CSV table +

Parent Element	CSV Field /Element	Old CSV Field Name	Mandatory	Type	Size	V
TrustedServer	ServerCode		Yes	PK	20	+2.0
TrustedServer	FirstIP		Yes	<i>xsd:NMTOKEN</i>	16	+2.0
TrustedServer	LastIP		Yes	<i>xsd:NMTOKEN</i>	16	+2.0
TrustedServer	Description		No	<i>xsd:string</i>	20	1.0
TrustedServer	CreationDateTime	Date of Issue	No	<i>xsd:dateTime</i>	25	+2.0
TrustedServer	ModificationDateTime	Date of Last Change	No	<i>xsd:dateTime</i>	25	+2.0
TrustedServer	RevisionNumber	Issue Version	No	<i>typed</i>	5	+2.0
TrustedServer	Modification	<i>new</i>	No	enum	3	+2.0

Table 15-14 – NPTG: TrustedServer.csv Content

15.7.5 NPTG Discovery: WebApplications CSV table +

Parent Element	CSV Field /Element	Old CSV Field Name	Mandator y	Type	Size	V
WebApp	WebApplicationCode	<i>new</i>	Yes	PK (NMTOKEN)	20	+2.0
WebApp	Version	<i>new</i>	Yes	PK (String)	20	+2.0
WebApp	WebApplicationClassification	<i>new</i>	No	<i>xsd:string</i>	20	+2.0
WebApp	Description	<i>new</i>	No	<i>xsd:string</i>	50	+2.0
WebApp	Staging	<i>new</i>	No	<i>xsd:string</i>	50	+2.0
WebApp	ServerCode	<i>new</i>	No	<i>FK</i>	20	+2.0
WebApp	WebApplication URL	JWV ersion	No	<i>xsd:string</i>	20	1.0
WebApp	CreationDateTime	Date of Issue	No	<i>xsd:dateTime</i>	25	1.0 *
WebApp	ModificationDateTime	Date of Last Change	No	<i>xsd:dateTime</i>	25	1.0 *
WebApp	RevisionNumber	Issue Version	No	<i>typed</i>	5	1.0 *
WebApp	Modification	<i>new</i>	No	<i>enum</i>	3	+2.0

Table 15-15 – NPTG: WebApplications.csv Content

15.7.6 NPTG Discovery: WebAppCapabilities CSV table +

Parent Element	CSV Field /Element	Old CSV Field Name	Mandator y	Type	Size	V
WebAppCap	WebApplicationCode	<i>new</i>	Yes	PK, FK	8	+2.0
WebAppCap	Version	<i>new</i>	Yes	PK, FK	20	+2.0
WebAppCap	CapabilityCode	<i>new</i>	Yes	<i>PK</i>	8	+2.0
WebAppCap	CreationDateTime	<i>new</i>	No	<i>xsd:dateTime</i>	25	1.0 *
WebAppCap	ModificationDateTime	<i>new</i>	No	<i>xsd:dateTime</i>	25	1.0 *
WebAppCap	RevisionNumber	<i>new</i>	No	<i>typed</i>	5	1.0 *
WebAppCap	Modification	<i>new</i>	No	<i>enum</i>	3	+2.0

Table 15-16 – NPTG: WebAppCapabilities.csv Content

15.7.7 NPTG Discovery: RegionApplications CSV table +

Parent Element	CSV Field /Element	Old CSV Field Name	Mandator y	Type	Size	V
RegionApp	RegionCode	<i>new</i>	Yes	PK, FK	8	1.0
RegionApp	WebApplicationCode	<i>new</i>	Yes	PK, FK	8	+2.0
RegionApp	Version	<i>new</i>	Yes	PK, FK	20	+2.0
RegionApp	CreationDateTime	<i>new</i>	No	<i>xsd:dateTime</i>	25	+2.0
RegionApp	ModificationDateTime	<i>new</i>	No	<i>xsd:dateTime</i>	25	+2.0
RegionApp	RevisionNumber	<i>new</i>	No	<i>typed</i>	5	+2.0
RegionApp	Modification	<i>new</i>	No	<i>enum</i>	3	+2.0

Table 15-17 – NPTG: RegionApplications.csv Content

15.7.8 NPTG Discovery: AdminAreaApplications CSV table +

Parent Element	CSV Field /Element	Old CSV Field Name	Mandator y	Type	Size	V
AdminApp	AdministrativeAreaCode	<i>new</i>	Yes	PK, FK	3	+2.0
AdminApp	WebApplicationCode	<i>new</i>	Yes	PK, FK	10	+2.0
AdminApp	Version	<i>new</i>	Yes	PK, FK	20	+2.0
AdminApp	CreationDateTime	<i>new</i>	Yes	<i>xsd:dateTime</i>	25	+2.0
AdminApp	ModificationDateTime	<i>new</i>	No	<i>xsd:dateTime</i>	25	+2.0
AdminApp	RevisionNumber	<i>new</i>	No	<i>typed</i>	5	+2.0
AdminApp	Modification	<i>new</i>	No	<i>enum</i>	3	+2.0

Table 15-18 – NPTG: AdminAreaApplications.csv Content

15.7.9 NPTG Discovery: LocalityApplications CSV table +

Parent Element	CSV Field /Element	Old CSV Field Name	Mandator y	Type	Size	V
----------------	--------------------	--------------------	------------	------	------	---

Parent Element	CSV Field /Element	Old CSV Field Name	Mandatory	Type	Size	V
LocalityApp	NptgLocalityCode	<i>new</i>	Yes	PK, FK	8	+2.0
LocalityApp	WebApplicationCode	<i>new</i>	Yes	PK, FK	10	+2.0
LocalityApp	Version	<i>new</i>	Yes	PK, FK	20	+2.0
LocalityApp	CreationDateTime	<i>new</i>	No	<i>xsd:dateTime</i>	25	+2.0
LocalityApp	ModificationDateTime	<i>new</i>	No	<i>xsd:dateTime</i>	25	+2.0
LocalityApp	RevisionNumber	<i>new</i>	No	<i>typed</i>	5	+2.0
LocalityApp	Modification	<i>new</i>	No	<i>enum</i>	3	+2.0

Table 15-19 – NPTG: LocalityApplications.csv Content

15.7.10 NPTG Discovery: StopPointApplications CSV table +

Parent Element	CSV Field /Element	Old CSV Field Name	Mandatory	Type	Size	V
StopPointApp	AtcoCode	<i>new</i>	Yes	PK, FK	12	+2.0
StopPointApp	WebApplicationCode	<i>new</i>	Yes	PK, FK	10	+2.0
StopPointApp	Version	<i>new</i>	Yes	PK, FK	20	+2.0
StopPointApp	CreationDateTime	<i>new</i>	No	<i>xsd:dateTime</i>	25	+2.0
StopPointApp	ModificationDateTime	<i>new</i>	No	<i>xsd:dateTime</i>	25	+2.0
StopPointApp	RevisionNumber	<i>new</i>	No	<i>typed</i>	5	+2.0
StopPointApp	Modification	<i>new</i>	No	<i>enum</i>	3	+2.0

Table 15-20 – NPTG: StopPointApplications.csv Content

15.8 NaPTAN CSV Format

This appendix describes the *NaPTAN* CSV exchange format. It presents:

- A diagram of the *NaPTAN* 1.2 CSV tables and their interrelationships.
- A diagram of the revised *NaPTAN* 2.1 CSV tables and their interrelationships.
- A list of the *NaPTAN* CSV table names.
- Detailed descriptions of the contents of each *NaPTAN* CSV table.

Figure 15-4 shows the previous data fields and relationships between each of the csv exchange tables in the *NaPTAN* 1.2 format.

- *NaPTAN* elements are shown shaded in green. For example, 'Nat Gaz'.
- Fields deprecated in 1.1 have a '-' against them.
- Derived Fields are shown in brackets. For example, '(Lon)'
- Required fields are shown in bold.
- Primary keys are indicated by a 'PK'. Foreign keys by an 'FK'.

Figure 15-5 shows the data fields and relationships between each of the CSV exchange tables in the *NaPTAN* 2.1 format. The same conventions are used. In addition:

- *NaPTAN* 2.x schema element names are used as the field names.
- Fields added in 2.0 have a '+' against them. For example 'Language+'.
- Fields whose types have been revised have a * against them – this is restricted to revising *Date* to be a *DateTime*. Fields whose enums values are not marked.

15.8.1 NaPTAN 1.1 CSV Exchange Format Overview

Figure 15-4 shows the previous data fields and relationships between each of the csv exchange tables in the *NaPTAN* for 1.2

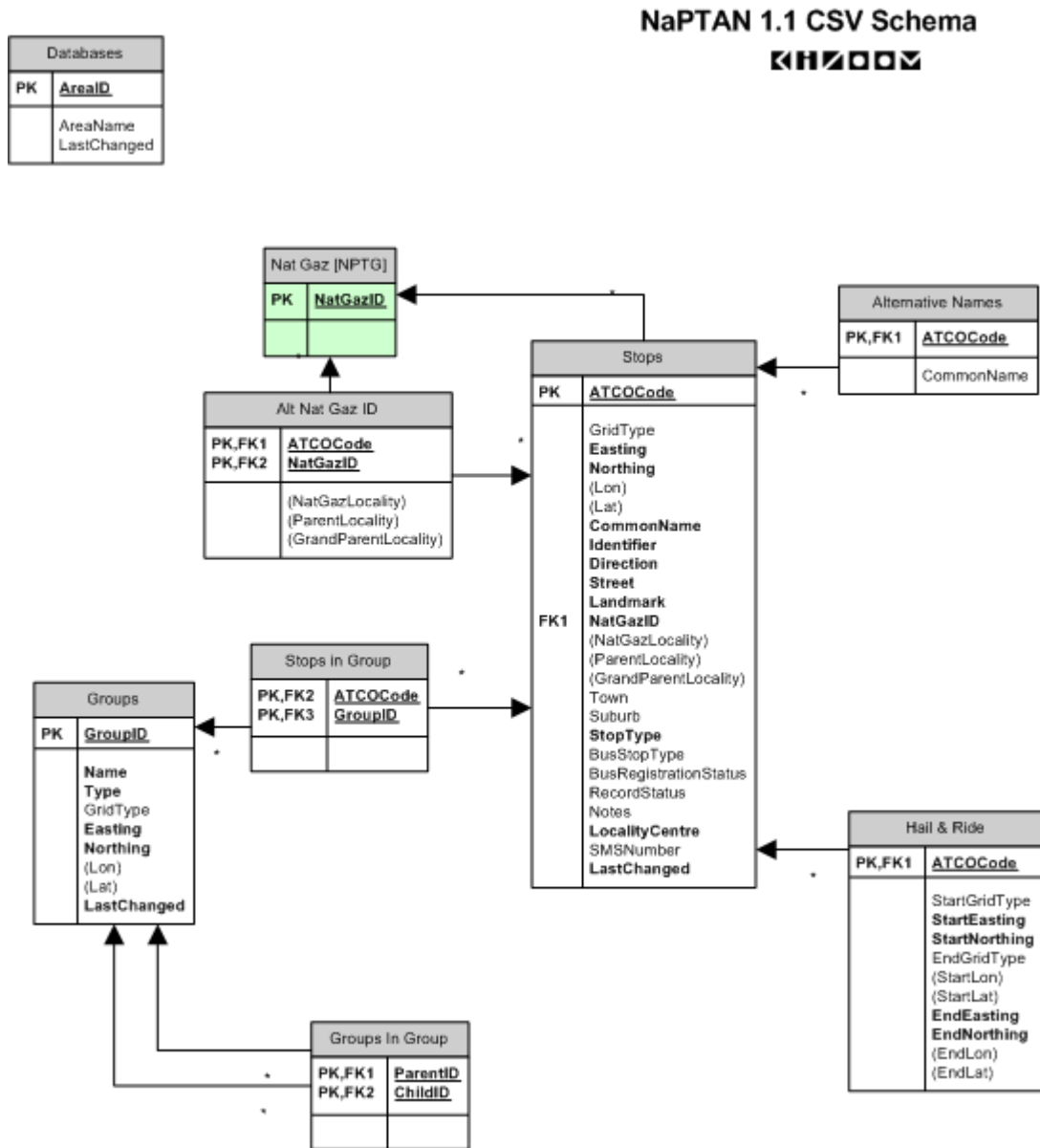

Figure 15-4 – Diagram of NaPTAN 1.1 CSV Tables

15.9 NaPTAN: CSV Files

	Content	New Name	Old File name		Version
Stop Point	Stop Point	Stops.csv	Stops.csv	Basic	1.0
	Alternative Stop Names	AlternativeDescriptors.csv	AltNames.csv	Basic	1.0
	Additional Gazetteer Entries	StopLocalities.csv	AltNatGaz.csv	Basic	1.0
	Stop Availability	StopAvailability.csv		Basic	+2.0
	Hail & Ride Stop Details	HailRide.csv	HailRide.csv	Basic	1.0
	Flexible Stop Details	Flexible.csv		Basic	+2.0
	Air Reference	AirReferences.csv	Air Exchange.csv	Full	NPTG 1.0
	Ferry Reference	Ferry References.csv		Full	+2.0
	Rail Reference	RailReferences.csv	Rail Exchange.csv	Full	NPTG 1.0
	Metro Reference	MetroReferences.csv		Full	+2.0
	Coach Reference	CoachReferences.csv	Coach Exchange.csv	Full	NPTG 1.0
	Main Stop Points for Locality	LocalityMainAccessPoints.csv		Full	+2.0
Stop Area	Stop Plusbus Zones	StopPlusbusZones.csv		Full	+2.0
	Stop Area	StopAreas.csv	Groups.csv	Basic	1.0
	Stops in Stop Area	StopsInArea.csv	StopsInGroup.csv	Basic	1.0
	Stop Area Hierarchy	AreaHierarchy.csv	GroupsInGroup.csv	Basic	1.0

Table 15-21 – NaPTAN CSV files

Table 15-21 Shows the NaPTAN 2.0 CSV files. Each CSV file must contain a header row containing the corresponding field names for each file. Some derived fields are only present in exports from the NaPTAN database. If these derived fields are included in data intended for import into the database they will simply be ignored.

15.9.1 NaPTAN: StopPoint CSV table

Parent Element	CSV Field /Element	Old CSV Field Name	Mandatory	Type	Size	V
StopPoint	AtcoCode	ATCOCode	Yes	PK	12	1.0
Identifiers	NaptanCode	SMSNumber	No	AK	12	1.0
	PlateCode	new	No	<i>nmtojen</i>	12	2.0
	CleardownCode	new	No	<i>int</i>	10	+2.0
Descriptor	CommonName	same	Yes	<i>placeName</i>	48	1.0
	CommonNameLang+	new	No	<i>xml:language</i>	2	+2.0
	ShortCommonName	new	No	<i>placeName</i>	48	+2.0
	ShortCommonNameLang+	new	No	<i>xml:language</i>	2	+2.0
	Landmark	same	No (2.1)	<i>name</i>	48	1.0
	LandmarkLang+	new	No	<i>xml:language</i>	2	+2.0
	Street	same	No (2.1)	<i>placeName</i>	48	1.0
	StreetLang+	new	No	<i>xml:language</i>	2	+2.0
	Crossing	new	No	<i>placeName</i>	48	+2.0
	CrossingLang+	new	No	<i>xml:language</i>	2	+2.0
	Indicator	Identifier	No	<i>placeName</i>	48	1.0
	IndicatorLang+	new	No	<i>xml:language</i>	2	+2.0
	Bearing	Direction	Yes	<i>bearing</i>	2	1.0
Place	NptgLocalityCode	NatGazID	Yes	FK	8	1.0
--derived	LocalityName	NatGazLocality	Derived	<i>placeName</i>	48	1.0
--derived	ParentLocalityName	ParentNatGazLocality	Derived	<i>placeName</i>	48	1.0
--derived	GrandParentLocalityName	NatGazLocality	Derived	<i>placeName</i>	48	1.0
Place	Town	same	No	<i>placeName</i>	48	1.0
	TownLang+	new	No	<i>xml:language</i>	2	+2.0
Place	Suburb	same	No	<i>placeName</i>	48	1.0
	SuburbLang+	new	No	<i>xml:language</i>	2	+2.0
	Country	new	No	<i>enum</i>		+2.5
StopPoint	LocalityCentre	same	Yes	<i>xsd:boolean</i>	1	*1.0
Place	GridType	same	No	<i>gridType</i>	1	1.0
Place	Easting	same	Yes	<i>easting</i>	6	1.0
Place	Northing	same	Yes	<i>northing</i>	7	1.0
--derived	Longitude	lon	Derived	<i>longitude</i>		1.0
--derived	Latitude	lat	Derived	<i>latitude</i>		1.0
StopPoint	StopType	StopType	Yes	<i>enum</i>	3	1.0
Bus	BusStopType	BusStopType	No	<i>enum</i>	3	1.0
Bus	TimingStatus	BusRegistrationStatus	No	<i>enum</i>	3	1.0

Parent Element	CSV Field /Element	Old CSV Field Name	Mandatory	Type	Size	V
Bus	DefaultWaitTime	DefaultWaitTime	No	duration		
StopPoint	Notes	same	No	<i>nString</i>	*	1.0
StopPoint	NotesLang+	new	No	<i>xml:language</i>	2	+2.0
StopPoint	AdministrativeAreaCode+	new	Yes	FK	8	+2.0
StopPoint	MobilityImpairedAccess	new	No	<i>enum</i>	7	+2.5
StopPoint	WheelchairAccess	new	No	<i>enum</i>	7	+2.5
StopPoint	StepFreeAccess	new	No	<i>enum</i>	7	+2.5
StopPoint	LiftFreeAccess	new	No	<i>enum</i>	7	+2.5
StopPoint	EscalatorFreeAccess	new	No	<i>enum</i>	7	+2.5
StopPoint	AssistanceService	new	No	<i>enum</i>	7	+2.5
StopPoint	ServicesNormally-Accessibles	new	No	<i>enum</i>	22	+2.5
StopPoint	AccessibilityNote	new	No	<i>xml:language</i>	*	+2.5
StopPoint	Infolr!	new	No	<i>Xsd:anyURI</i>	*	+2.5
StopPoint	CreationDateTime+	new	No	<i>xsd:dateTime</i>	10	+2.0
StopPoint	ModificationDateTime	LastChanged	No	<i>xsd:dateTime</i>	10	*1.0
StopPoint	RevisionNumber+	new	No	<i>revision</i>	5	+2.0
StopPoint	Modification	RecordStatus	No	<i>modification</i>	3	1.0
StopPoint	Status	RecordStatus	No	<i>enum</i>	3	1.0

Table 15-22 – NaPTAN: Stops.csv Content

- (1) FLX stop type is added to **BusStopType**.
- (2) PEN (Pending) status is added to **Status**.

15.9.2 NaPTAN: Hail & Ride CSV Table

Parent Element	Transfer Field	Old CSV Field Name	Mandatory	Type	Size	V
HailAndRideSection	AtcoCode	ATCOCode	Yes	PK, FK	12	1.0
StartPoint	StartGridType	same	Yes	<i>gridType</i>	1	1.0
	StartEasting	same	Yes	<i>easting</i>	6	1.0
	StartNorthing	same	Yes	<i>northing</i>	7	1.0
EndPoint	EndGridType	same	Yes	<i>gridType</i>	1	1.0
	EndEasting	same	Yes	<i>easting</i>	6	1.0
	EndNorthing	same	Yes	<i>northing</i>	7	1.0
HailAndRideSection	CreationDateTime	new	No	<i>xsd:dateTime</i>	10	+2.0
HailAndRideSection	ModificationDateTime	new	No	<i>xsd:dateTime</i>	10	+2.0
HailAndRideSection	RevisionNumber	new	No	<i>revision</i>	5	+2.0
HailAndRideSection	Modification+	new	No	<i>modification</i>	3	+2.0

Table 15-23 – NaPTAN: HailRide.csv Content

15.9.3 NaPTAN: Flexible CSV Table

Parent Element	Transfer Field	Old CSV Field Name	Mandatory	Type	Size	V
FlexibleZone	AtcoCode	new	Yes	PK, FK	12	2.0
FlexibleZone	Sequence	new	Yes	<i>xsd:integer</i>	5	2.0
Location	GridType	new	Yes	<i>gridType</i>	1	2.0
Location	Easting	new	Yes	<i>easting</i>	6	2.0
Location	Northing	new	Yes	<i>northing</i>	7	2.0
FlexibleZone	CreationDateTime	new	No	<i>xsd:dateTime</i>	10	+2.0
FlexibleZone	ModificationDateTime	new	No	<i>xsd:dateTime</i>	10	+2.0
FlexibleZone	RevisionNumber	new	No	<i>revision</i>	5	+2.0
FlexibleZone	Modification+	new	No	<i>modification</i>	3	+2.0

Table 15-24 – NaPTAN: Flexible.csv Content

15.9.4 NaPTAN: AlternativeDescriptor Table

Parent Element	Transfer Field	Old CSV Field Name	Mandatory	Type	Size	V
Descriptor	AtcoCode	ATCOCode	Yes	PK, FK	12	1.0
Descriptor	CommonName	same	Yes	<i>placeName</i>	48	1.0
CommonName	CommonNameLang+	new	No	<i>xml:language</i>	2	+2.0

Descriptor	ShortName	same	Yes	<i>placeName</i>	48	1.0
ShortName	ShortCommonNameLang+	new	No	<i>xml:language</i>	2	+2.0
Descriptor	Landmark	same	No (2.1)	<i>placeName</i>	48	1.0
LandMark	LandmarkLang+	new	No	<i>xml:language</i>	2	+2.0
Descriptor	Street	same	No (2.1)	<i>placeName</i>	48	1.0
Street	StreetLang+	new	No	<i>xml:language</i>	2	+2.0
Descriptor	Crossing	same	Yes	<i>placeName</i>	48	+2.0
Crossing	CrossingLang+	new	No	<i>xml:language</i>	2	+2.0
Descriptor	Indicator	Identifier	Yes	<i>placeName</i>	48	1.0
Indicator	IndicatorLang+	new	No	<i>xml:language</i>	2	+2.0
Descriptor	CreationDateTime	new	Yes	<i>xsd:dateTime</i>	10	+2.0
Descriptor	ModificationDateTime	new	No	<i>xsd:dateTime</i>	10	+2.0
Descriptor	RevisionNumber	new	No	<i>revision</i>	5	+2.0
Descriptor	Modification+	new	No	<i>modification</i>	3	+2.0

Table 15-25 – NaPTAN: AlternativeDescriptor.csv Content

15.9.5 NaPTAN: StopLocalities Table

Parent Element	Transfer Field	Old CSV Field Name	Mandatory	Type	Size	V
AltLocalities	AtcoCode	ATCOCode	Yes	PK, FK	12	1.0
AltLocalities	NptgLocalityCode	NatGazID	Yes	PK, FK	8	1.0
--derived	(LocalityName)	NatGazLocality	Derived	<i>placeName</i>	48	1.0
--derived	(ParentLocalityName)	ParentNatGazLocality	Derived	<i>placeName</i>	48	1.0
--derived	(GrandParent-LocalityName)	NatGazLocality	Derived	<i>placeName</i>	48	1.0
AltLocalities	CreationDateTime	new	No	<i>xsd:dateTime</i>	10	+2.0
AltLocalities	ModificationDateTime	new	No	<i>xsd:dateTime</i>	10	+2.0
AltLocalities	RevisionNumber	new	No	<i>revision</i>	5	+2.0
AltLocalities	Modification+	new	No	<i>modification</i>	3	+2.0

Table 15-26 – NaPTAN: StopLocalities.csv Content

15.9.6 NaPTAN: StopAvailabilities Table

Parent Element	Transfer Field	Old CSV Field Name	Mandatory	Type	Size	V
StopAvailability	AtcoCode	new	Yes	PK, FK	12	+2.0
StopAvailability	StartDate	new	Yes	PK, xsd:date	8	+2.0
StopAvailability	EndDate	new	No	<i>xsd:date</i>	8	+2.0
StopAvailability	AvailabilityStatus	new	Yes	<i>Enum (Active Suspended Transferred)</i>	48	+2.0
StopAvailability	Note	new	No	<i>nlString</i>	*	+2.0
Note	NoteLang+	new	No	<i>language</i>	2	+2.0
StopAvailability	TransferStopAtcoCode	new	No	FK	12	+2.0
StopAvailability	CreationDateTime	new	No	<i>xsd:dateTime</i>	10	+2.0
StopAvailability	ModificationDateTime	new	No	<i>xsd:dateTime</i>	10	+2.0
StopAvailability	RevisionNumber	new	No	<i>revision</i>	5	+2.0
StopAvailability	Modification+	new	No	<i>modification</i>	3	+2.0

Table 15-27 – NaPTAN: StopAvailabilities.csv Content

15.9.7 NaPTAN: StopsInStopArea Table

Parent Element	Transfer Field	Old CSV Field Name	Mandatory	Type	Size	V
StopAreaRef	StopAreaCode	GroupID	Yes	PK, FK	12	1.0
StopAreaRef	AtcoCode	ATCOCode	Yes	PK, FK	12	1.0
StopAreaRef	CreationDateTime+	new	No	<i>xsd:dateTime</i>	10	+2.0
StopAreaRef	ModificationDateTime+	new	No	<i>xsd:dateTime</i>	10	+2.0
StopAreaRef	RevisionNumber+	new	No	<i>revision</i>	5	+2.0
StopAreaRef	Modification+	new	No	<i>modification</i>	3	+2.0

Table 15-28 – NaPTAN: StopsInStopArea.csv Content

15.9.8 NaPTAN: AirReferences Table

Parent Element	Transfer Field	Old CSV Field Name	Mandatory	Type	Size	V
AirReference	AtcoCode	new	Yes	PK, FK	12	+2.0
AirReference	IataCode	new	Yes	code	12	+2.0
AirReference	Name	same	No	<i>nlString</i>	48	1.0
Name	NameLang	new	Yes	<i>enum</i>	2	+2.0
AirReference	CreationDateTime	new	No	<i>xsd:dateTime</i>	10	1.0*
AirReference	ModificationDateTime	new	No	<i>xsd:dateTime</i>	10	+2.0
AirReference	RevisionNumber	new	No	<i>revision</i>	5	1.0*
AirReference	Modification+	new	No	<i>modification</i>	3	+2.0

Table 15-29 – NaPTAN: AirReferences.csv Content

15.9.9 NaPTAN: RailReferences Table

Parent Element	Transfer Field	Old CSV Field Name	Mandatory	Type	Size	V
RailReference	AtcoCode	new	Yes	PK, FK	12	+2.0
RailReference	TiplocCode	Tiploc Code	Yes	code	12	1.0
RailReference	CrsCode	Crs Code	No	code	5	1.0
RailReference	StationName	Station Name	No	<i>nlString</i>	48	1.0
StationName	StationNameLang+	new	No	<i>xml:language</i>	2	+2.0
Location	GridType	new	No	<i>gridType</i>	1	+2.0
Location	Easting	same	Yes	<i>easting</i>	6	1.0
Location	Northing	same	Yes	<i>northing</i>	7	1.0
RailReference	CreationDateTime	new	No	<i>xsd:dateTime</i>	10	1.0*
RailReference	ModificationDateTime	new	No	<i>xsd:dateTime</i>	10	+2.0
RailReference	RevisionNumber	new	No	<i>revision</i>	5	1.0*
RailReference	Modification+	new	No	<i>modification</i>	3	+2.0

Table 15-30 – NaPTAN: RailReferences.csv Content

15.9.10 NaPTAN: FerryReferences Table

Parent Element	Transfer Field	Old CSV Field Name	Mandatory	Type	Size	V
FerryReference	AtcoCode+	new	Yes	PK, FK	12	+2.0
FerryReference	FerryCode	new	Yes	PK, Code	12	+2.0
FerryReference	Name	same	No	<i>nlString</i>	48	+2.0
Name	NameLang+	new	Yes	<i>enum</i>	2	+2.0
Location	GridType+	new	No	<i>gridType</i>	1	+2.0
Location	Easting	same	Yes	<i>easting</i>	6	+2.0
Location	Northing	same	Yes	<i>northing</i>	7	+2.0
FerryReference	CreationDateTime	new	No	<i>xsd:dateTime</i>	10	+2.0
FerryReference	ModificationDateTime	new	No	<i>xsd:dateTime</i>	10	+2.0
FerryReference	RevisionNumber	new	No	<i>revision</i>	5	+2.0
FerryReference	Modification+	new	No	<i>modification</i>	3	+2.0

Table 15-31 – NaPTAN: FerryReferences.csv Content

15.9.11 NaPTAN: MetroReferences Table

Parent Element	Transfer Field	Old CSV Field Name	Mandatory	Type	Size	V
MetroRef	AtcoCode+	new	Yes	PK, FK	12	+2.0
MetroRef	MetroCode	new	Yes	PK, Code	12	+2.0
MetroRef	Name	same	No	<i>nlString</i>	48	+2.0
Name	NameLang+	new	Yes	<i>enum</i>	2	+2.0
Location	GridType+	new	No	<i>gridType</i>	1	+2.0
Location	Easting	same	Yes	<i>easting</i>	6	+2.0
Location	Northing	same	Yes	<i>northing</i>	7	+2.0
MetroRef	CreationDateTime	new	No	<i>xsd:dateTime</i>	10	+2.0
MetroRef	ModificationDateTime	new	No	<i>xsd:dateTime</i>	10	+2.0
MetroRef	RevisionNumber	new	No	<i>revision</i>	5	+2.0
MetroRef	Modification+	new	No	<i>modification</i>	3	+2.0

Table 15-32 – NaPTAN: MetroReferences.csv Content

15.9.12 NaPTAN: CoachReferences Table

Parent Element	Transfer Field	Old CSV Field Name	Mandatory	Type	Size	V
CoachRef	AtcoCode+	new	Yes	PK, FK	12	+2.0
CoachRef	OperatorCode	new	No	code	12	+2.1
CoachRef	NationalCoachCode	new	Yes	PK, Code	12	1.0
CoachRef	Name	same	No	<i>nIString</i>	48	1.0
Name	NameLang+	new	Yes	<i>enum</i>	2	+2.0
CoachRef	LongName	new	No	<i>nIString</i>	48	1.0
LongName	LongNameLang+	new	No	<i>xml:language</i>	2	+2.0
Location	GridType+	new	No	<i>gridType</i>	1	+2.0
Location	Easting	same	Yes	<i>easting</i>	6	1.0
Location	Northing	same	Yes	<i>northing</i>	7	1.0
CoachRef	CreationDateTime	new	No	<i>dateTime</i>	10	1.0*
CoachRef	ModificationDateTime	new	No	<i>dateTime</i>	10	+2.0
CoachRef	RevisionNumber	new	No	<i>revision</i>	5	1.0*
CoachRef	Modification+	new	No	<i>modification</i>	3	+2.0

Table 15-33 – NaPTAN: CoachReferences.csv Content

15.9.13 NaPTAN: LocalityMainAccessPoints Table

Parent Element	Transfer Field	Old CSV Field Name	Mandatory	Type	Size	V
MainAcces	AtcoCode	new	Yes	PK, FK	12	+2.0
MainAcces	NptgLocalityCode	new	Yes	PK, FK	8	+2.0
MainAcces	CreationDateTime	new	No	<i>xsd:dateTime</i>	10	+2.0
MainAcces	ModificationDateTime	new	No	<i>xsd:dateTime</i>	10	+2.0
MainAcces	RevisionNumber	new	No	<i>revision</i>	5	+2.0
MainAcces	Modification+	new	No	<i>modification</i>	3	+2.0

Table 15-34 – NaPTAN: LocalityMainAccessPoints.csv Content

15.9.14 NaPTAN: StopPlusBusZones Table

Parent Element	Transfer Field	Old CSV Field Name	Mandatory	Type	Size	V
StopPlusbusZone	AtcoCode	new	Yes	PK, FK	12	+2.0
StopPlusbusZone	PlusbusZoneCode	new	Yes	PK, FK	10	+2.0
StopPlusbusZone	CreationDateTime	new	No	<i>xsd:dateTime</i>	10	+2.0
StopPlusbusZone	ModificationDateTime	new	No	<i>xsd:dateTime</i>	10	+2.0
StopPlusbusZone	RevisionNumber	new	No	<i>revision</i>	5	+2.0
StopPlusbusZone	Modification+	new	No	<i>modification</i>	3	+2.0

Table 15-35 – NaPTAN: StopPlusBusZones.csv Content

15.9.15 NaPTAN: StopAreas (Groups Table)

Parent Element	Transfer Field	Old CSV Field Name	Mandatory	Type	Size	V
StopArea	StopAreaCode	GroupID	Yes	PK	12	1.0
StopArea	Name	GroupName	Yes	<i>placeName</i>	48	1.0
Name	NameLang+	new	No	<i>xml:language</i>	2	+2.0
StopArea	AdministrativeAreaCode+	new	Yes	FK	8	+2.0
StopArea	StopAreaType	Type	Yes	<i>enum (1)</i>	4	1.0
Location	GridType	same	No	<i>gridType</i>	1	1.0
Location	Easting	same	Yes	<i>easting</i>	6	1.0
Location	Northing	same	Yes	<i>northing</i>	7	1.0
StopArea	CreationDateTime+	new	Yes	<i>xsd:dateTime</i>	10	+2.0
StopArea	ModificationDateTime	LastChanged	No	<i>xsd:dateTime</i>	10	1.0
StopArea	RevisionNumber+	new	No	<i>revision</i>	5	+2.0
StopArea	Modification+	new	No	<i>modification</i>	3	+2.0
StopPoint	Status	new	No	<i>enum</i>	3	+2.0

Table 15-36 – NaPTAN: StopAreas.csv Content

- (1) **StopAreaType** values as for XML schema.
- (2) GCCH added to **StopAreaType**.

15.9.16 NaPTAN: StopAreaHierarchy Table

Parent Element	Transfer Field	Old CSV Field Name	Mandatory	Type	Size	V
ParentStopArea	ParentStopAreaCode	ParentID	Yes	PK, FK	12	1.0
ParentStopArea	ChildStopAreaCode	ChildID	Yes	PK, FK	12	1.0
ParentStopArea	CreationDateTime+	new	No	<i>xsd:dateTime</i>	10	+2.0
ParentStopArea	ModificationDateTime	LastChanged	No	<i>xsd:dateTime</i>	10	+2.0
ParentStopArea	RevisionNumber+	new	No	<i>revision</i>	5	+2.0
ParentStopArea	Modification+	new	No	<i>modification</i>	3	+2.0

Table 15-37 – NaPTAN: StopAreaHierarchy.csv Content

15.10 Common CSV Types

The NaPTAN and NPTG CSV schemas use a only a small number of common data types. These are documented in Table 15-38.

Note that csv GridType enumerations are changed in 2.0 to follow the 2.0 XML – Blank or UKOS denotes UK grid (1.1 OSGR), IrishOS denotes Irish Grid (Irish Grid letter)

Data Type	Size	Default Value	Notes	Example	V
<i>placeName</i>	48	--	Extension of Natural language string. Not empty. Only characters, letters accents and ! ' - / permitted.	Westward Ho!	1.0*
<i>nString</i>	*	--	Natural language string. Not empty. Associated with a <i>language</i> field.		1.0
<i>xsd:string</i>	*	--	Any character	Hello world?	1.0*
<i>xsd:dateTime</i>	15 ??	--	Yyyy-mm-ddThh:mm:ss:nn:zz ISO format	2004-12-17T09:30:47-05:00	1.0*
<i>xml:language</i>	2	en	ISO types en or cy	en	1.0
<i>gridType</i>	1	U	Blank or U = UKOS I = IrishOS	U	1.0
<i>easting</i>	6	0	OS easting	505000	1.0
<i>northing</i>	7	0	OS northing	185000	1.0
<i>longitude</i>	8	0	WGS 84 longitude		1.0
<i>latitude</i>	8	0	WGS 84 latitude		1.0
<i>bearing</i>	2		Enum of S SE SW N NE NW E W	S	1.0
<i>BearingDegrees</i>	2		0-360	48	2.0+
<i>apd:email</i>	*		aa@bbb	me@foo.org	2.0+
<i>apd:phone</i>	18		Apd type country + code + extension	+442072699890	2.0+
<i>ipAddress</i>	15		999.999.999.999	196.168.0.1	2.0+
<i>revision</i>	5	0	Integer incrementing	00045	1.0
<i>modification</i>	3	revised	new = new del = deleted rev = revised (1)	rev	1.0*
<i>status</i>	3	OTH	act = Active, pen = Pending, del = Inactive	act	1.0*
<i>code</i>			Used for codes – no embedded blanks		

Table 15-38 – Common NPTG and NaPTAN CSV Data Types

15.11 ATCO & Administrative Area Codes

ATCO Code	Admin Area Name	Travel Rgn	Ctry	Admin Area
639	Aberdeen	S	Sct	111
630	Aberdeenshire	S	Sct	112
649	Angus	S	Sct	113
607	Argyll & Bute	S	Sct	114
18	Bath & North East Somerset	SW	Eng	1
20	Bedford	SE	Eng	69
258	Blackburn with Darwen	NW	Eng	2
259	Blackpool	NW	Eng	3
532	Blaenau Gwent	W	Wal	4
129	Bournemouth	SW	Eng	5
38	Bracknell Forest	SE	Eng	6
551	Bridgend	W	Wal	7
149	Brighton and Hove	SE	Eng	8
10	Bristol	SW	Eng	9
40	Buckinghamshire	SE	Eng	70
554	Caerphilly	W	Wal	10
50	Cambridgeshire	EA	Eng	71
571	Cardiff	W	Wal	11
522	Carmarthenshire	W	Wal	12
21	Central Bedfordshire	SE	Eng	151
523	Ceredigion	W	Wal	13
60	Cheshire East	NW	Eng	72
61	Cheshire West & Chester	NW	Eng	152
668	Clackmannanshire	S	Sct	116
513	Conwy	W	Wal	14
80	Cornwall	SW	Eng	73
90	Cumbria	NE	Eng	74
76	Darlington	NE	Eng	15
511	Denbighshire	W	Wal	16
109	Derby	EM	Eng	17
100	Derbyshire	EM	Eng	75
110	Devon	SW	Eng	76
120	Dorset	SW	Eng	77
680	Dumfries & Galloway	S	Sct	118
640	Dundee	S	Sct	119
130	Durham	NE	Eng	78
618	East Ayrshire	S	Sct	120
611	East Dunbartonshire	S	Sct	121
627	East Lothian	S	Sct	122

612	East Renfrewshire	S	Sct	123
220	East Riding of Yorkshire	Y	Eng	18
140	East Sussex	SE	Eng	79
620	Edinburgh	S	Sct	124
150	Essex	SE	Eng	80
111	Exeter *	SW	Eng	153
669	Falkirk	S	Sct	125
650	Fife	S	Sct	126
512	Flintshire	W	Wal	19
609	Glasgow	S	Sct	127
160	Gloucestershire	SW	Eng	81
490	Greater London	L	Eng	82
180	Greater Manchester	NW	Eng	83
540	Gwynedd	W	Wal	20
68	Halton	NW	Eng	21
190	Hampshire	SW	Eng	84
75	Hartlepool	NE	Eng	22
209	Herefordshire	WM	Eng	23
210	Hertfordshire	SE	Eng	85
670	Highland	S	Sct	128
613	Inverclyde	S	Sct	129
541	Isle of Anglesey	W	Wal	24
230	Isle of Wight	SE	Eng	25
240	Kent	SE	Eng	86
229	Kingston upon Hull	Y	Eng	26
250	Lancashire	NW	Eng	87
269	Leicester	EM	Eng	27
260	Leicestershire	EM	Eng	88
270	Lincolnshire	EM	Eng	89
29	Luton	SE	Eng	28
249	Medway	SE	Eng	29
280	Merseyside	NW	Eng	90
553	Merthyr Tydfil	W	Wal	30
79	Middlesbrough	NE	Eng	31
628	Midlothian	S	Sct	130
49	Milton Keynes	SE	Eng	32
533	Monmouthshire	W	Wal	33
638	Moray	S	Sct	131
920	National - National Air	GB	GB	145
900	National - National Coach	GB	GB	143
930	National - National Ferry	GB	GB	146

Department for Transport
NPTG and NaPTAN Schema Guide

Annex

Appendixes

910	National - National Rail	GB	GB	110
910	National - National Rail	GB	GB	144
940	National - National Tram	GB	GB	147
582	Neath Port Talbot	W	Wal	34
531	Newport	W	Wal	35
290	Norfolk	EA	Eng	91
617	North Ayrshire	S	Sct	132
228	North East Lincolnshire	EM	Eng	36
616	North Lanarkshire	S	Sct	133
227	North Lincolnshire	EM	Eng	37
19	North Somerset	SW	Eng	38
291	Norwich *	SW	Eng	154
320	North Yorkshire	Y	Eng	92
300	Northamptonshire	EM	Eng	93
310	Northumberland	NE	Eng	94
339	Nottingham	EM	Eng	39
330	Nottinghamshire	EM	Eng	95
602	Orkney Islands	S	Sct	134
340	Oxfordshire	SE	Eng	96
521	Pembrokeshire	W	Wal	40
648	Perth & Kinross	S	Sct	135
59	Peterborough	EM	Eng	41
118	Plymouth	SW	Eng	42
128	Poole	SW	Eng	43
199	Portsmouth	SW	Eng	44
561	Powys	W	Wal	45
39	Reading	SE	Eng	46
78	Redcar & Cleveland	NE	Eng	47
614	Renfrewshire	S	Sct	136
552	Rhondda Cynon Taff	W	Wal	48
268	Rutland	EM	Eng	49
690	Scottish Borders	S	Sct	115
603	Shetland Islands	S	Sct	137
350	Shropshire	WM	Eng	97
37	Slough	SE	Eng	50
360	Somerset	SW	Eng	98

619	South Ayrshire	S	Sct	138
17	South Gloucestershire	SW	Eng	51
615	South Lanarkshire	S	Sct	139
370	South Yorkshire	Y	Eng	99
198	Southampton	SW	Eng	52
158	Southend-on-Sea	SE	Eng	53
380	Staffordshire	WM	Eng	100
660	Stirling	S	Sct	140
77	Stockton-on-Tees	NE	Eng	54
389	Stoke-on-Trent	WM	Eng	55
390	Suffolk	EA	Eng	101
400	Surrey	SE	Eng	102
581	Swansea	W	Wal	56
468	Swindon	SW	Eng	57
359	Telford & Wrekin	WM	Eng	58
159	Thurrock	SE	Eng	59
119	Torbay	SW	Eng	60
534	Torfaen	W	Wal	61
410	Tyne & Wear	NE	Eng	103
572	Vale of Glamorgan	W	Wal	62
69	Warrington	NW	Eng	63
420	Warwickshire	WM	Eng	104
30	West Berkshire	SE	Eng	64
608	West Dunbartonshire	S	Sct	117
629	West Lothian	S	Sct	141
430	West Midlands	WM	Eng	105
440	West Sussex	SE	Eng	106
450	West Yorkshire	Y	Eng	107
601	Western Isles	S	Sct	142
460	Wiltshire	SW	Eng	108
36	Windsor & Maidenhead	SE	Eng	65
35	Wokingham	SE	Eng	66
200	Worcestershire	WM	Eng	109
514	Wrexham	W	Wal	67
329	York	Y	Eng	68

* : TABLE ALREADY INCLUDES EXETER AND NORWICH FROM APRIL 2011

15.12 Index

- &
 - In Stop Names, 74
- <odes
 - Network, 129
- 910
 - National Code, 93, 101
- 920
 - National Code, 65
- 940
 - Metro prefix, 108
- Abbreviations
 - NPTG Locality Names, 47
 - Standard list, 215
 - Use in Stop Names, 74
- Access Areas
 - Transport, 66
- AccessArea
 - Air, 64
 - Airport, 114
 - Bus & Coach, 65, 117
 - Ferry, 65
 - Ferry Port, 114
 - Metro, 65, 66, 116, 118
 - NaPTAN Model, 52
 - Point of interest, 132
 - Rail, 65, 115
- Accessibility. *See* Stop Accessibility
 - Booking, 57
- AccessVehicle
 - Accessibility, 122, 123
 - Stop Accessibility, 121
- Acronyms
 - NPTG Locality Names, 47
- Active
 - status, 191
 - Status, 191
 - Stop Status, 75
 - Stop Validity Status, 119
 - Versioning, 192
- AddressTypes-v1-3.xsd
 - Package, 202
- Adjacent Localities
 - CSV, 223
- Adjacent Region Points
 - CSV, 223
- AdjacentLocality.csv
 - Table, 220
- AdjacentLocalityRefr
 - Change Attributes, 194
- AdjacentRegionExchangePoint
 - Change Attributes, 194
- AdjacentRegionExchangePoints
 - Discovery Model, 82
- AdjacentRegionPoint
 - NPTG Discovery Element, 139
- AdjacentRegionPoints
 - Element, 135
- AdminAreas.csv
 - Table, 219
- administrative area, 28
- Administrative area
 - Export, 28
- Administrative Area
 - ATCO codes, 66
 - Boundaries, 64
 - Choosing, 43
 - Stop Types, 108
- AdministrativeArea
 - Change Attributes, 194
 - Element, 92
 - NaPTAN Model, 49
 - NPTG Locality, 95
 - NPTG Model, 34
 - NptgLocality Model, 32
 - Point of Interest**, 131
 - Region Element, 92
 - Stop points, 107
- AdministrativeAreaCode
 - Element, 92
 - Uniqueness, 206
- AdministrativeAreaName
 - Uniqueness, 207
- AdministrativeAreaRef
 - NaPTAN element, 107, 131
 - NaPTAN Integrity, 209
 - Networks, 129
 - NPTG Discovery, 208
 - Stop Areas, 128
 - WebApplication, 137
- AdministrativeAreas
 - CSV, 220
- Air
 - Air Entrance Stop Type, 108
 - NaPTAN Model, 52
 - Off-Street Stop Classification, 113
- AIR
 - Airport Entrance Stop Type, 76, 108
 - Stop Point Type, 54, 64
- Airport
 - Example, 181
- Airport
 - Names, 75
 - Stop Area, 69
 - Stop Areas, 69
 - Stop Points, 64
- Airport
 - Terminal Entrances, 113
- Airport Entrance
 - Stop Type, 76
- Airport Interchange
 - Stop Type, 76
- AlphaPrefix
 - Element, 93
 - NaptanCode, 102
- AlternativeDescriptor
 - Change Attributes, 193, 194
 - CSV, 230
 - NaPTAN Model, 48
 - NPTG Locality, 95
 - NptgLocality, 32
 - Stop Point, 105
- AlternativeName
 - NaPTAN Integrity, 209
- AlternativeName / Name
 - Uniqueness, 207
- AlternativeNptgLocalities
 - Stop Point, 105
- AlternativerNptgLocalityRef
 - Change Attributes, 193
- Ampersand
 - Administrative Areas, 43
- AnnotatedAirRef
 - Change Attributes, 193
- AnnotatedAirRef
 - Element, 114
 - NaPTAN Model, 52
- AnnotatedCablewayRef
 - Element, 118
- AnnotatedCoachRef
 - Change Attributes, 194
- AnnotatedCoachRef
 - Element, 117
 - Element, on-street, 111
 - NaPTAN Model, 52
- AnnotatedFerryRef
 - Change Attributes, 194
- AnnotatedFerryRef
 - Element, 114
 - NaPTAN Model, 52
- AnnotatedMetroRef
 - Change Attributes, 194
- AnnotatedMetroRef
 - Element, 116
 - NaPTAN Model, 52
- AnnotatedRailRef
 - Change Attributes, 194
- AnnotatedRailRef
 - Element, 115
 - NaPTAN Model, 52
- AnnotatedVenueRef
 - Element, 132
- Apostrophes
 - In Stop Names, 73
 - NPTG Locality Names, 47
- Articles
 - NPTG Locality Names, 47
- AssistanceNeeded
 - Element, 124
- AssistanceServiceAvailability
 - Stop Accessibility, 121
- AssistanceTimes
 - Stop Accessibility, 122
- AssistedBoardingLocation
 - Element, 124
- Associations
 - Status, 192
- AtcoAreaCode
 - Administrative Area element, 92
 - Stop Point, 101
- ATCO-CIF
 - Standards, 22
- AtcoCode
 - Allocating, 66
 - Identifiers, 26
 - Identifiers, 87
 - NaPTAN Integrity, 208
 - NaPTAN Stop Point, 101, 131
- Atomicity Principle
 - Stop Names, 71
- AutomaticDoors
 - Element, 123
- Availability. *See* Stop Availability
 - CallCentre, 140, 141
- Bay
 - Bus & Coach, 117
 - NaPTAN Model, 52

- BCE**
 Bus & Coach Station Entrance
 Stop Type, 76
 Example, 177
 Stop Point Type, 54, 65
- BCQ**
 Stop Point Type, 54, 65
 Variable Bus Stop Type, 108
 Variable Stop Type, 77
- BCS**
 Bus & Coach Station Stop
 Type, 76, 108
 Bus and Coach Station Bus
 Stop Type, 76
 Example, 177
 Stop Point Type, 54
- BCT**
 Bus Coach Stop Type, 108
 Stop Point Type, 54
- Bearing**
 Bus Stop Points, 111
 Element, 147
 Hail & Ride Section, 112
 Stop Naming, 70
- Berth**
 Ferry Port, 114
- BoardingHeight**
 Element, 123
- Borough**
 NptgLocality, 32
- Brackets**
 NPTG Locality Names, 46
- BST**
 Bus & Coach Access Stop
 Type, 108
 Stop Point Type, 54
- Bus**
 NaPTAN Model, 52
 On-Street, 52
 Stop Type, 76, 108
- Bus & Coach Station**
 Stop type, 76
- Bus and Coach Station**
 Stop Points, 65
- Bus Entrance**
 Stop Type, 76
- Bus Interchange**
 Example, 159
- Bus or Coach Station**
 Stop Area, 69
- Bus Station**
 Example, 177
- Bus Stop**
 Example both sides, different
 names, 149, 151
 Example one side only, 157
 Example one side only,
 landmark, 154
- Bus Stop**
 Names, 71
- Bus Stop**
 Hail & Ride, 161
- Bus Stop**
 Flexible Zones, 163
- BusAndCoach**
 Off-Street Stop Classification,
 117
- BusCoach**
 Bus & Coach Stop
 Classification, 108
- BusStopClassificationGroup**
 Group, 111
- CablewayRef**
 Element, 118
- Call Centre**
 AreasCSV, 224
 CSV, 224
- CallCentre**
 Change Attributes, 194
 Element, 135
 NPTG Discovery Element, 139
- CallCentreCode**
 Identifiers, 87
 Uniqueness, 208
- CallCentreRef**
 CallCentre, 140
- CallCentres**
 Discovery Model, 82
- Camel Case**
 Conventions, 184
- CapabilityClassification**
 NPTG Discovery Element, 136
- Capitalization**
 NPTG Locality, 45
 Stop Names, 72
- Carl Bro**
 NaPTAN Development, 15
- Category**
 Point of Interest, 133
- Change Attributes**
 NPTG Schema, 90
- Changes**
 Release 2.1, 19
 Release 2.2, 19
 Release 2.3, 19
 Release 2.4, 19
 Release 2.5, 19
- ChangesSince**
 NaPTAN Schema, 100
- Character Set**
 Allowed values, 45
 Forbidden values, 45
 Forbidden values, 45
 NPTG Locality Name, 97
 Stop Names, 72
- Choosing Stop Names, 64**
- City**
 NPTG Settlement, 95
- City Centre**
 NPTG Locality, 44
- CleardownCode**
 Identifiers, 87
 NaPTAN element, 103
- CleardownRange**
 Element, 93
- Coach**
 National Codes, 66
 Stop Area, 69
 Stop Points, 64
 Stop Type, 76
- Coach Reference**
 Stop Point, 111
- Coach station**
 Stop Point, 117, 118
- Coach Station**
 Entrances, 66
- Coach Station Entrance**
 Stop Type, 76
- CoachCode**
 NaPTAN Integrity, 210
- CoachRef**
 Element, 117
- Comma Separated Variable. See CSV**
- Commas**
 In Stop Names, 73
- Common Name**
 Presentation, 77
- CommonName**
 Maximum Length, 93
 Naming, 70
 Stop Point descriptor, 104
- CommonSimpleTypes.xsd**
 Package, 202
- CompassPoint**
 Bearing, 147
- ContactEmail**
 Administrative Area, 93
- ContactTelephone**
 Administrative Area, 93
- Cosham**
 Example, 149
- Country**
 NaPTAN place element, 105
 Plusbus, 98
 Region element, 92
- Coverage**
 Discovery Model, 82
- CreationDateTime**
 Attribute, 185, 186
 Change Attribute, 190, 194
 Discovery Schema, 134
 NaPTAN Schema, 99
 NPTG Schema, 90
 Schema attribute, 189
- Crossing**
 In Bus Stop Names, 72
 NaPTAN descriptor element,
 104
 Stop Naming, 70
- Crown Copyright**
 NaPTAN IPR, 17
- CRS**
 See. See CrsRef
- CrsRef**
 Rail Stop Point, 115
- CSV**
 Exchange format, 216
 NaPTAN, 26
 NPTG, 25
- CUS**
 Bus Stop Point Type, 54
 Custom Bus Stop Type, 76
- Custom**
 Bus Stop CUS, 76
- Data Export**
 Process, 28
- Data Import**
 Process, 28
- Data types**
 Common, 206
 CSV, 235
 principles, 185
- DataSource**
 NaPTAN Schema, 100
- DateRange**
 Stop Validity, 119
- DayOffset**
 Element, 125
- DaysOfWeek**

- Element, 125, 126
- DayType
 - Element, 125
- DayTypes
 - Call Centres, 141
- DefaultWaitTime
 - NaPTAN Element, 111
- Degrees
 - Bearing, 147
- Delete
 - Modification, 190
- Department for Transport
 - IPR, 17
 - JourneyWeb, 212
 - NaPTAN, 14
 - TransModel, 212
 - TransXChange, 212
- Descriptor
 - NaPTAN Model, 48
 - NaPTAN Stop Point, 103, 104
 - NPTG Locality, 95
 - Stop Area, 69
 - Stop Names, 70
- DirectTelephone
 - CallCentre, 140
- Disambiguation
 - Stop Names, 77
- Discovery. *See* NPTG Discovery
- District
 - NPTG, 95
- Districts.csv
 - Table, 220
- Document
 - File name, 90
- Duration
 - Data type, 145
- Easting
 - Location, 146
- Email
 - Transport of Schemas, 26
- EndArea
 - Point of interest, 132
- EndPoint
 - Hail & Ride Section, 112
- EndTime
 - Element, 125
- Entrance
 - Air, 64
 - Airport, 113
 - Bus, 65
 - Bus & Coach, 117
 - Ferry Port, 114
 - Metro, 65, 66, 116, 118
 - NaPTAN Model, 52
 - Point of interest, 132
 - Rail, 65, 115
 - Stop Point Type, 65
- EscalatorFreeAccess
 - Stop Accessibility, 121
- Example
 - Airport, 181
 - Bus Interchange, 159
 - Bus Station with Bays, 177
 - Bus Stop on One Side of a Road with No Landmark, 157
 - Flexible Zones, 163
 - Hail & Ride, 161
 - Metro Station, 172
 - Pole One Side Only with Landmark, 154
 - Poles Both Sides of the Road with Different Common Names, 151
 - Poles Both Sides of the Road with One Landmark, 149
 - Rail Station, 166
- Examples
 - Introduction, 148
- FBT
 - Stop Point Type, 54
- FER
 - Stop Point Type, 54
- Ferry
 - NaPTAN Model, 52
 - Off-Street Stop Classification, 114
 - Stop Area, 69
 - Stop Points, 65
- FerryCode
 - NaPTAN Integrity, 210
- FerryRef
 - Element, 114
- FileName
 - Attribute, 185, 186
 - Discovery Schema, 134
 - NaPTAN Schema, 99
 - NPTG Schema, 90
- Flexible
 - Bus Stop Type, 76
- Flexible Stop
 - CSV, 230
- Flexible Zones
 - Example, 163
- FlexibleZone
 - Change Attributes, 193
- FlexibleZone
 - Bus Stop Classification, 113
 - FlexibleZone Bus Stop Type, 108, 110
 - NaPTAN Model, 52
- FLX
 - Bus Stop Point Type, 54
 - Flexible Bus Stop Type, 76
- FLX'
 - Example, 163
- FromRegionRef
 - AdjacentRegionPoints, 139
- FTD
 - Ferry Entrance Stop Type, 76
 - Ferry Terminal Coach Stop Type, 108
 - Stop Point Type, 54, 65
- FTP
 - Transport of Schemas, 26
- GAIR
 - Airport Stop Area, 68
 - Stop Area Type, 54, 65, 128
- GapToPlatform
 - Element, 123
- GAT
 - Air Access Area Stop Type, 108
 - Airport Interchange Stop Type, 76
 - Stop Point Type, 54, 65
- GBCS
 - Example, 177
 - Stop Area, 69
 - Stop Area Type, 54, 65, 128
- GBPS
 - Example, 149, 151
 - Stop Area Type, 54, 128
- GCCH
 - Coach Stop Area, 69
 - Guidance, 64
 - Stop Area Type, 54, 128
- GCLS
 - Example, 159
 - Guidance, 64
 - Stop Area, 68
 - Stop Area Type, 54, 128
- geocode. *See* Location
- Geocoding
 - NPTG Localities, 47
- GFTD
 - Ferry Stop Area, 68
 - Stop Area Type, 54, 65, 128
- GMLT
 - Deprecated Stop Area Type, 128
- GOTH
 - Deprecated Stop Area Type, 128
- GovTalk
 - IPR, 17
 - NaPTAN, 16
 - Reference, 214
- GPBS
 - Example, 166
 - On-street Pole Bus Stop Area, 68
- Grid
 - Standards, 23
- GridType
 - Location, 146
 - NaPTAN Schema, 90, 100
- GRLS
 - Example, 166
 - Rail Station Stop Area, 69
 - Stop Area Type, 54, 65, 128
- GTMU
 - Example, 172
 - Stop Area Type, 54, 65, 66, 128
 - Tram Metro Underground Stop Area, 69
- Guidance
 - NaPTAN Stop Names, 64
 - NPTG Names, 43
- GuideDogsAllowed
 - Element, 124
- Hail & Ride
 - Example, 161
- Hail & Ride
 - Bus Stop, 76
 - Coordinates, 76
 - Location, 106
- Hail & Ride
 - CSV, 230
- HailAndRide
 - Change Attributes, 193
- HailAndRide
 - Bus Stop Classification, 112
 - Hail & Ride Bus Stop Type, 108, 110
- HailAndRideSection
 - NaPTAN Model, 52
- Hamlet
 - NPTG Settlement, 95
- HAR

- Bus Stop Point Type, 54
 - Example, 161
 - Hail & Ride Bus Stop Type, 76, 108, 110
- HeightOfAccessArea
 - Element, 123
- Hierarchy
 - CSV, 220
 - Locality, 44
 - Stop Areas, 69
- HoistOperatingRadius**
 - Accessibility, 123
- HolidayTypes
 - Call Centres, 141
- http
 - Transport of Schemas, 26
- Hyphenation
 - Locality Names, 46
 - Stop Names, 72
- IATA
 - Airport Names, 75
- lataCode
 - NaPTAN Integrity, 210
- lataRef
 - Element, 114
- id**
 - attribute, 87
- Id
 - Attribute, 186
- Identifiers
 - NaPTAN stop point, 102
- Inactive*, 191
 - Status, 191
 - Stop Status, 119
- Indicator
 - Naming Styles, 72
 - NaPTAN descriptor element, 104
 - Presentation*, 77
 - Stop Naming, 70
- InfoUrl
 - Stop Accessibility, 122
- Integrity checks
 - NaPTAN, 206
 - NaPTAN, 208
 - NPTG, 206
 - NPTG Discovery, 207
- Intellectual Property Rights
 - NaPTAN & NPTG, 17
- IpAddressRange
 - TrustedServer, 138
- ISO 639-1
 - reference, 213
- ITM Grid coordinates
 - NaPTAN database, 75
- Journey Planner
 - Stop Names, 77
 - Use Case, 28
- Journey Planning
 - Suppliers, 15
- JourneyWeb
 - Adjacent Regions, 82
 - NaPTAN, 15
 - Reference, 212
 - Standards, 22
- Kizoom
 - NaPTAN Development, 15
- Landmark
 - NaPTAN descriptor element, 104
- Stop naming, 70
- Language
 - NPTG Schema, 90
- Languages
 - Standards, 214
- Latitude
 - Location, 146
- LiftFreeAccess
 - Stop Accessibility, 121
- Localities.csv
 - Table, 220
- Locality
 - Main Point of Access, 49
 - NPTG, 31
- Locality Hierarchy
 - CSV, 223
- LocalityAlternativeNames.csv
 - Table, 220
- LocalityApplications
 - CSV, 225
- LocalityCentre
 - Main Point of Access, 105
 - NaPTAN Place element, 105
- LocalityClassification
 - NPTG Element, 95
- LocalityHierarchy.csv
 - Table, 220
- LocalityName
 - NPTG Descriptor, 97
- Location
 - AdjacentRegionPoints, 139
 - Air Port, 114
 - cableway Station, 118
 - Coach Station, 117
 - Coordinates, 75
 - Data type, 145
 - Ferry Port, 114
 - Flexible Zone, 113
 - Hail & Ride, 112
 - Identifiers, 87
 - Metro Station, 116
 - NaPTAN Model, 48
 - NaPTAN Place element, 106
 - NPTG Locality, 96
 - NptgLocality, 32
 - Plusbus zones, 98
 - Point of Interest, 132
 - Rail Stations, 115
 - Stop Area, 128
 - StopPoint, 75
- LocationSystem, 145
 - Attribute, 186
 - Discovery Schema, 134
 - NaPTAN Schema, 100
 - NPTG Schema, 90
- Longitude
 - Location, 146
- LongName
 - Coach Station, 117
- LowFloor
 - Accessibility, 123
- lusbusZones.csv
 - Table, 220
- Main Point of Access, 49
- Main points of access
 - NaPTAN Model, 49
- MainStopForNptgLocalityRef
 - Change Attributes, 193
- Map
 - Coordinates, 76
- Map-information
 - NaPTAN, 15
- Mapping
 - Plusbus Element, 98
- Marked
 - Bus Stop, 75
- MarkedPoint
 - Bus Stop Classification, 111
 - Marked Point Bus Stop Type, 108, 110
- MaximumLengthForShortNames
 - Administrative Area, 93
 - Stop point names, 104
- MET**
 - Example, 172
 - Metro Interchange Area Stop Type, 108
 - Stop Point Type, 54, 65, 66
- Metro
 - NaPTAN Model, 52
 - Off-Street Stop Classification, 116
- Metro & Underground Station
 - Stop Points, 65, 66
- Metro Entrance
 - Stop Type, 76
- Metro Platform
 - Stop Type, 76
- Metro Station
 - Example, 172
- Metro Station
 - Stop Area, 69
- Metropolitan PTE
 - NptgLocality, 32
- MetroRef
 - Identifier, 116
- MKD**
 - Bus Stop Type, 54
 - Marked Bus Stop Type, 76
- Mobile device
 - NaptanCode, 26
- MobilityImpairedAccess
 - Stop Accessibility, 120
- Mode
 - NaPTAN Model, 52
- Model
 - NaPTAN, 48
 - NaPTAN UML, 51
 - NPTG Discovery, 82
 - NPTG UML, 31, 32, 34
- modes of transport, 75
- Modification
 - Attribute, 185, 186
 - Change Attribute, 190, 194
 - Discovery Schema, 134
 - NaPTAN Schema, 100
 - NPTG Schema, 90
 - Schema attribute, 189
 - Versioning, 190
- ModificationDateTime
 - Attribute, 185, 186
 - Change Attribute, 190, 194
 - Discovery Schema, 134
 - NaPTAN Schema, 99
 - NPTG Schema, 90
 - Schema attribute, 189
 - Versioning, 195
- ModificationNumber
 - Schema attribute, 189
- Name

- Administrative Area, 92
- Airport, 114
- CallCentre, 140
- Coach Station, 117
- Ferry Port, 114
- Metro Station, 116
- Network, 129, 130
- NPTG District, 97
- Plusbus Zone, 98
- Stop Area, 128
- TrunkLocality**, 144
- Venue, 132
- Name Changes
 - Release 2.x, 18
- Names
 - Alternative, 105
 - Of Stops, 69
 - StopPoint Descriptors, 104
- Naming conventions
 - NaPTAN & NPTG, 184
- Naming Conventions Identifiers, 87
- NaPT_accessibility.xsd
 - Package, 202
- NaPT_dates.xsd
 - Package, 202
- NaPT_location.xsd
 - Package, 202
- NaPT_modes.xsd
 - Package, 202
- NaPT_operator.xsd
 - Package, 202
- NaPT_stopAccessibility.xsd
 - package, 202
- NaPT_stopAreas.xsd
 - Package, 202
- NaPT_stops.xsd
 - Package, 202
- NaPT_tariffZones.xsd
 - Package, 202
- NaPT_utility.xsd
 - mark, 202
- NaPT_utilityTypes.xsd
 - package, 202
- NaPT_versioningAttributes.xsd
 - mark, 202
- NaPTAN
 - CSV, 14
 - Database, 14
 - Integrity checks, 208
 - Process, 14
 - Schema, 14
- NaPTAN
 - Components, 14
 - Introduction, 14
- NaPTAN
 - IPR, 17
- NaPTAN
 - Release 2.x changes, 18
- NaPTAN
 - Purpose, 25
- NaPTAN
 - Identifiers, 25
- NaPTAN
 - Database, 26
- NaPTAN
 - Schema, 26
- NaPTAN
 - CSV, 26
- NaPTAN
 - CallCentre, 140
- Data exchange, 27
- NaPTAN
 - Data Model, 48
- NaPTAN
 - Populating Guidance, 64
- NaPTAN
 - Stop Areas, 69
- NaPTAN
 - Stop Names, 69
- NaPTAN
 - Schema, 99
- NaPTAN
 - Element, 99
- NaPTAN 1.1
 - CSV, 227
- NaPTAN 2.1
 - CSV, 228
- NaPTAN Database
 - IPR, 17
- NaPTAN Prefix
 - Discovery Model, 82
- NaPTAN.xsd
 - Package, 202
 - Schema, 202
- NaptanCode
 - Identifiers, 26
 - NaPTAN element, 102, 131
 - Prefix range, 93
- NaptanCoe
 - Identifiers, 87
- National
 - Administrative Areas, 64
 - Element, 93
 - Stop Point Area, 108
- National Coach
 - Code, 66
- National Code, 65
- national language
 - ISO639-1, 213
 - Rfc1766, 214
- National Language support
 - NaPTAN, 18
- National Languages, 204
- National Public Transport
 - Gazetteer. *See* NPTG
- NationalPublicTransportGazetteer
 - Schema, 90
- NaturalLanguageString
 - Data Type, 204
- NaturalLanguageStringStructure
 - Data type, 185
- NeTeX
 - Standards, 22
- Network
 - Element, 58
 - NaPTAN element, 129
 - NaPTAN Element, 100
 - NaPTAN Integrity, 208
- NetworkCode
 - Network identifier, 129
- New
 - Modification, 190
- Nothing
 - Location, 146
- Note
 - CallCentre Availabilit, 141
 - Stop Accessibility, 122
 - Stop Validity Status, 119
- Notes
 - CallCentre, 140
- NaPTAN element, 107, 131
- Stop Naming, 70
- NPTG
 - Components, 14
 - CSV, 25
 - CSV, 14
 - CSV 1.2, 216
 - Database, 25
 - Database, 14
 - Database Exchange. *See*
 - Integrity checks, 206
 - Introduction, 14
 - Model, 31
 - Populating Guidance, 43
 - Purpose, 25
 - Schema, 25, 90
 - Schemas, 14, 25
 - Topographical Model, 31
 - UML Diagram, 34
- NPTG & NaPTAN
 - Packages, 198, 200
- NPTG & NaPTAN Schema Guide
 - Organisation, 16
- NPTG & NaPTAN XML Schema Guide
 - Motivation, 15
- NPTG CSV
 - 1.2, 217
 - 2.1, 218
 - Discovery 2.1, 219
- NPTG Database
 - IPR, 17
- NPTG Discovery
 - CSV, 223
 - Integrity checks, 207
 - Model, 82
 - Purpose, 25
 - Schema, 134
- NPTG District
 - Choosing, 43
- NPTG Locality
 - Choosing, 43
 - CSV, 221
 - Geocoding, 47
 - Hierarchy, 44
 - Naming, 44
 - Qualifier, 44
- NPTG Locality Name
 - Stop Names, 71, 77
- NPTG Locality Names
 - Abbreviations, 47
 - Acronyms, 47
 - Apostrophes, 47
 - Articles, 47
 - Brackets, 46
 - Hyphenation, 46
- NPTG.xsd
 - Package, 202
 - Schema, 202
- NPTG_discovery.xsd
 - Package, 202
- NPTG_Discovery.xsd
 - Schema, 202
- NptgDiscovery
 - element, 135
 - Element, 134
- NptgDistrict
 - Administrative Area, 93
 - Change Attributes, 194
 - Element, 97

- NPTG Model, 34
- NptgLocality, 32
- Uniqueness, 207
- NptgDistrictCode
 - Element, 97
- NptgDistrictRef
 - Element, 95, 97
- NptgLocality
 - Change Attributes, 194
 - Definition, 31
 - Element, 95
 - Hierarchy, 31
 - NaPTAN Integrity, 209
 - NaPTAN Model, 49
 - Overview, 90
 - Primary, 75
 - Stop Areas, 49, 128
 - Stop Points, 105
 - Topographical Model, 31
 - Uniqueness, 207
- NptgLocalityCode
 - NPTG** Element, 95
- NptgLocalityRef
 - TrunkLocality**, 144
- NptgLocalityRef
 - Element, 97
 - Stop Point, 105
 - WebApplication, 137
- NptgLocalityRef
 - NaPTAN Integrity, 209
- NptgStopPointRef
 - TrunkLocality**, 145
- NptgStopPointRef
 - WebApplication, 137
- NumberOfSteps
 - Element, 123
- Off-street
 - Entrance points, 76
- OffStreet
 - NaPTAN Model, 52
 - Stop Classification, 108
 - Stop Point, 109
- On-street
 - Stops, 76
- OnStreet
 - NaPTAN Model, 52
 - Stop Classification, 108
 - Stop Point, 109
- On-street Bus
 - MKD*, 76
- On-street Cluster Bus
 - Stop Area, 69
- On-street Pair
 - Stop Area, 69
- OperatorRef
 - Stop Accessibility, 122
- OperatorRef
 - Element, 117
- OS Grid
 - Location, 106, 145
 - Location Schema, 90
- OS Grid coordinates
 - NaPTAN database, 75
- OS TOID
 - Annotation, 87
- OSGR
 - Standards, 23
- Packages
 - BPTG & NaPTAN, 198
- Paired On-Street Bus
 - Example, 149
- ParentAreaRef
 - Stop Area, 127
- ParentLocalityRef
 - Change Attributes, 194
- ParentLocalityRef
 - Cyclic references, 207
- ParentNptgLocalityRef
 - Element, 95
- ParentRef
 - NaPTAN Integrity, 210
- Passenger Transport Executives
 - NaPTAN, 15
- Pending*, 191
 - Status*, 191
- Period
 - In Stop Names, 73
- Place
 - NaPTAN element, 103, 105
 - NaPTAN Model, 48
- Place Of Interest
 - NPTG Settlement, 95
- Places of Interest
 - NPTG Locality, 44
- PlateCode
 - NaPTAN element, 103
- Platform
 - Metro, 116, 118
 - NaPTAN Model, 52
 - Rail, 115
- PLT*
 - Example, 172
 - Stop Point Type, 54
 - Stop Point Type Allocation, 66
 - Tram Metro Underground
 - Platform Stop Type, 76
 - Underground or Metro Platform
 - Stop Type, 108
- Plusbus zones
 - CSV, 223
- PlusbusZone
 - Element, 98
 - Identifiers, 87
 - NPTG Model, 34
 - Overview, 90
 - Stop points, 107
 - Uniqueness, 207
- PlusbusZoneRef
 - NaPTAN element, 107
 - NaPTAN Integrity, 209
- Point of interest
 - NaPTAN, 15
- Point of Interest
 - Element, 59
- Point of Interest
 - NPTG Locality, 44
- PointOfInterest**
 - NaPTAN element, 131
 - NaPTAN Integrity, 208
- PointOfInterest**
 - Element, 59
- PointOfInterest Types
 - NaPTAN Model, 60
- PointOfInterestClassification**
 - NaPTAN PointOfInterest, 131
 - Point of Interest Classification, 132
- PointX*
 - NPTG Locality, 44
- Port. *See* Ferry
- Position
 - WGS 84, 213
- Precision
 - Attribute, 186
- Principal Point
 - Stop Classification, 111
- PrivateCode
 - Identifiers, 87
 - NaPTAN element, 103, 131
 - Stop Area, 127
- PTAN
 - See* Stop point, 64
- PTP
 - Principal Timing Point, 110
- PublicTelephone
 - CallCentre, 140
- Qualifier
 - NPTG Locality, 44, 97
 - Stop Names, 71
- QualifierName
 - NPTG Element, 97
- Rail
 - Off-Street Stop Classification, 115
 - Rail, 52
- Rail station
 - Stop areas, 69
- Rail Station
 - Example, 166
- Rail Station
 - Stop Area, 69
 - Stop Point, 115
 - Stop Points, 65
- Rail Station Entrance
 - Stop Type, 76
- Rail Stations
 - Names, 74
- Ramp
 - Accessibility, 123
- RampBearingCapacity
 - Element, 123
- Real Time Information System
 - NaPTAN, 15
- Region
 - AdjacentRegionPoints, 139
 - Change Attributes, 194
 - Element, 92
 - NPTG Model, 34
 - Overview, 90
 - Uniqueness, 207
- RegionApplications
 - CSV, 225
- RegionCode
 - Element, 92
 - Uniqueness, 206
- RegionRef
 - NPTG Discovery, 208
 - WebApplication, 137
- Regions
 - CSV, 220
 - Discovery Model, 85
- Regions.csv
 - Table, 219
- Relationships
 - Implementation, 186
- Revise*
 - Modification, 190
- RevisionNumber
 - Attribute, 186
 - Change Attribute, 191, 195

- Discovery Schema, 134
- NaPTAN Schema, 100
- NPTG Schema, 90
- Versioning, 191
- Rfc 1766
 - national language, 214
- RLY
 - Stop Point Type, 54, 65
- RPL
 - Rail Platform Stop Type, 76
 - Stop Point Type, 54, 65
- RSE
 - Rail Entrance Stop Type, 108
 - Station Entrance Stop Type, 76
 - Stop Point Type, 54, 65
- Schema
 - Copyright, 17
 - NaPTAN, 26
 - NPTG, 25
 - Versioning, 18
 - XML, 14, 15
- Schemas
 - W3C reference, 213
- SchemaVersion
 - Attribute, 186
 - Discovery Schema, 134
 - NaPTAN Schema, 100
 - NPTG Schema, 90
 - Schema attribute, 189
- Season
 - Call Centres, 141
- Separators
 - Stop Names, 79
- ServerCode
 - TrustedServer, 138
- Service
 - Discovery, 82
- ServicesAtStopAreNormallyAccessible
 - Stop Accessibility, 122
- Severity
 - Errors, 206
- Shared
 - Taxi Rank Stop Type, 108
- Shared Taxi
 - Stop Type, 76
- SharedTaxiRank
 - On-Street Stop Classification, 113
- Shire
 - NptgLocality, 32
- ShortCommonName
 - Maximum length, 93
 - NaPTAN Integrity, 210
 - Stop Point Descriptor, 104
- ShortName
 - Network, 129, 130
- ShortName
 - Administrative Area, 92
 - NPTG Locality, 97
- SiteAccessibility
 - NaPTAN Stop Point, 122
- SiteAccessibility
 - NaPTAN element, 131
- SiteAccessibilityGroup
 - NaPTAN Stop Point, 121
 - Stop Accessibility, 120
- SiteDescriptionGroup
 - NaPTAN Stop Point, 101, 131
- Slash
 - In Stop Names, 74
- SMS
 - NaPTAN code, 102
 - NaptanCode, 26
- SourceLocalityType
 - Element, 95
- South East region
 - Journey Planner, 77
- Spatial Location. *See* Location
- Staging
 - NPTG Discovery
 - WebApplication, 136
- Stance. *See* BCS
- Standards
 - Govtalk, 214
 - ISO Time, 213
 - TransXChange, 212
 - W3C schema, 213
 - WGS 84, 213
- StartPoint
 - Hair & Ride Section, 112
- StartTime
 - Element, 125
- StationName
 - Rail Stop Point, 115
- Status
 - Attribute, 186
 - Change Attribute, 191, 195
 - In Associations, 192
 - NaPTAN Integrity, 209
 - Stop Point, 119
- StepFreeAccess
 - Stop Accessibility, 121
- Stop area
 - Choosing names, 68
- Stop Area
 - Airport Example, 181
 - Bus Station Example, 177
 - Example Rail Station, 166
 - Naming, 75
- Stop Area Types
 - NaPTAN Model, 54
- Stop Classification**
 - UML Diagram**, 56
- Stop finder
 - Stop names, 77
- Stop Name
 - Maximum Length, 93
- Stop Names
 - Capitalization, 72
 - Hyphenation, 72
 - Permitted Characters, 72
 - Presentation, 70
 - Separators, 79
 - Use of Abbreviations, 74
 - Use of Ampersand, 74
 - Use of spaces, 74
- Stop Point
 - Accessibility, 120
 - Discovery, 82
 - NaPTAN, 64
 - Types, 108
 - Validity Periods, 119
- Stop Points
 - Naming, 69
- StopAccessibility
 - Change Attributes, 194
 - Element, 57
 - NaPTAN element, 107
- NaPTAN Stop Point, 120
- StopAccessibilityGroup
 - Stop Accessibility, 120
- StopArea
 - Air, 65
 - Change Attributes, 193
 - Ferry, 65
 - Hierarchy, 69
 - Location, 49
 - NaPTAN element, 127
 - NaPTAN Element, 100
 - NaPTAN Integrity, 209
 - NaPTAN Model, 48
 - NptgLocality, 49, 128
 - Rail, 65
 - Stop points, 106
 - Types, 54
- StopAreaCode
 - NaPTAN Integrity, 208
 - Stop Area identifier, 127
- StopAreaParentRef
 - NaPTAN Integrity, 209
- StopAreaRef
 - Change Attributes, 193
 - NaPTAN Integrity, 209, 210
- StopAreaRef
 - NaPTAN element, 106
- StopAreaType
 - NaPTAN Model, 54
 - Stop Area Classification, 128
- StopAvailabilities
 - CSV, 231
- StopAvailability
 - NaPTAN element, 107
 - NaPTAN Stop Point, 119
 - Statuses, 191
- StopClassification
 - NaPTAN Stop Point, 101
- StopClassification
 - NaPTAN Model, 48, 52
- StopClassification
 - NaPTAN element, 108
- StopFurtherDetailsGroup
 - NaPTAN Stop Point, 102
- StopIdentifierGroup
 - NaPTAN Stop Point, 101
 - StopPoint element, 102
- StopPoint
 - TrunkLocality**, 145
- StopPoint
 - Model, 82
 - NaPTAN element, 100
 - NaPTAN Model, 48
 - Types, 52
- StopPoint
 - Change Attributes, 193
- StopPoint
 - Change Attributes, 194
- StopPoint
 - CSV, 229
- StopPointRef
 - AdjacentRegionPoints, 139
 - NaPTAN Integrity, 210
 - NPTG Discovery, 208
- StopReferencesGroup
 - NaPTAN Stop Point, 101
- StopType
 - NaPTAN element, 108
 - NaPTAN Model, 52
 - Stop Areas, 54

- StopValidity
 - Change Attributes, 193
- StopValidity
 - NaPTAN Stop Point, 119
 - Versioning, 192, 193
- STR
 - Guidance, 64
 - Shared Taxi Rank Stop Type, 76
 - Stop Point Type, 54
- Street
 - NaPTAN descriptor element, 104
 - Stop Naming, 70
- Suburb
 - NaPTAN place element, 105
 - NPTG Settlement, 95
 - StopPoint, 75
- SuitableFor
 - Element, 123
- Suspended
 - Stop Validity Status, 119
- TariffZone
 - Element, 58
 - NaPTAN element, 130
 - NaPTAN Integrity, 208
 - Stop points, 107
- TariffZone
 - Network, 129
- TariffZone
 - Change Attributes, 194
- TariffZone** Code
 - Network identifier, 130
- TariffZoneRef
 - NaPTAN element, 107
 - NaPTAN Integrity, 209
- TariffZoneRef
 - Change Attributes, 194
- Taxi
 - NaPTAN Model, 52
 - On-Street Stop Classification, 113
 - Stop Point, 64
 - Stop Type, 76
- TaxiRank
 - Stop Type, 108
- TelCountryCode
 - Element, 144
- TelephoneContactStructure
 - Structure, 144
- TelExtensionNumber
 - Element, 144
- TelNationalNumber
 - Element, 144
- Time Formats
 - ISO 8601, 213
 - Standards, 213
- Time Info Point
 - Stop Classification, 111
- Timeband
 - Element, 125
- Times
 - CallCentre Availability, 141
- Timing point
 - Bus Stop, 75
- TimingStatus
 - Bus & Coach point, 117
 - Stop Point, 110
- TIPLOC
 - NaPTAN Codes, 66
- Rail identifier, 115
- TiplocCode
 - NaPTAN Integrity, 210
- TiplocRef
 - Rail Stop Point, 115
- TMU
 - Example, 172
 - Stop Point Type, 54, 65, 66
 - Tram Metro Underground
 - Entrance Stop Type, 76
 - Tram Metro Underground Stop Type, 108
- Topographical Model
 - NPTG, 31
- ToRegionRef
 - AdjacentRegionPoints, 139
- Tourism
 - NaPTAN, 15
- Town
 - NaPTAN place element, 105
 - NPTG Locality, 44
 - NPTG Settlement, 95
 - StopPoint, 75
- Town Centre
 - Stop Point, 105
- Traffic Area Offices
 - NaPTAN, 15
- Tram
 - Stop Points, 66
- Tram Entrance
 - Stop Type, 76
- Transferred
 - Stop Validity Status, 119
- Translation
 - Data type, 146
- Translation
 - Location, 146
- TransModel
 - Reference, 212
 - Standards, 22
 - Terminology, 203
- Transport Direct Portal
 - Journey Planner, 78
 - NaPTAN, 15
- Transport Direct Project
 - IPR, 17
- TransXChange
 - Default Wait Times, 111
 - PrivateCode, 103
 - References, 212
 - Standards, 22
 - Stop Areas, 127
 - Use case, 28
- Traveline
 - NaPTAN, 15
 - Regions, 34
- TrunkLocalities
 - Discovery Model, 82
 - Element, 136
- TrunkLocality
 - NPTG Discovery Element, 144
- TrustedServer
 - Change Attributes, 194
 - CSV, 224
 - Element, 135
 - NPTG Discovery Element, 138
- TrustedServers
 - Discovery Model, 82
- TXR
 - Guidance, 64
- Stop Point Type, 54
- Taxi Rank Type, 108
- Taxi Stop Type, 76
- UKOS
 - NaPTAN Root, 90, 100
- UML Diagram
 - NaPTAN Model, 49
 - Notations, 20
 - NPTG Discovery Model, 82
 - NPTG Model, 34
 - Stop Classification, 56**
- Underground. *See* Metro, *See* Metro
 - Off-Street Stop Classification, 116
- Underground Entrance
 - Stop Type, 76
- Underground Platform
 - Stop Type, 76
- Unified Modelling Language (UML). *See* UML
- Unique name
 - Locality, 97
- Uniqueness
 - NPTG, 206
- Unitary Authority
 - NptgLocality, 32
- UnmarkedPoint
 - Bus Stop Classification, 112
 - Unmarked Point Bus Stop Type, 108, 110
- Uppercase
 - NPTG Locality, 45
- URL
 - WebApplication Element, 136
- Use Cases
 - NaPTAN & NPTG, 27
 - NaPTAN Compilation and Distribution, 27
 - NaPTAN Gathering and Distribution, 27
 - NaPTAN Place Finder, 28
 - NaPTAN Stop Finder, 29
 - NaPTAN TransXChange use, 28
- UsedBy
 - WebApplication, 137
- User interface
 - Stop Names, 77
- Validation
 - XML, 29
- Variable Bus & Coach
 - Stop Type, 77
- VariableBay
 - Bus & Coach, 117
 - Stop Type, 108
- VenueClassification
 - NaPTAN Model, 49
- VenueRef
 - Element, 132
- Version
 - NaPTAN Schema, 100
 - Schema, 90
 - WebApplication Element, 136
- Version numbering, 188
- Versioning
 - NaPTAN & NPTG, 18
 - Revision number, 90
- Versions
 - Overview, 188
- Vertical bar

- In Stop Names, 74
- Village
 - NPTG Settlement, 95
- W3C
 - reference, 213
 - Schemas, 15
- Web Services
 - Discovery Model, 82
- WebAppCapabilities
 - CSV, 225
- WebApplication
 - Change Attributes, 194
 - Element, 135
 - NPTG Discovery Element, 136
 - Uniqueness, 207
- WebApplicationAdminAreaRef
 - Change Attributes, 194
- WebApplicationClassification
 - NPTG Discovery Element, 136
- WebApplicationCode
 - NPTG Discovery Element, 136
- WebApplicationLocalityRef
 - Change Attributes, 194
- WebApplicationRegionRef
 - Change Attributes, 194
- WebApplications
 - Discovery Model, 82
- WebApplicationStopPointRef
 - Change Attributes, 194
- Welsh
 - NaPTAN, 204
- WGS 84
 - Location, 75, 145
 - Location System, 90
 - NaPTAN, 18
 - NaPTAN Root, 100
 - NPTG Discovery Root, 134
 - reference, 213
 - Standards, 23
- WheelchairAccess
 - Stop Accessibility, 121
- WidthOfAccessArea
 - Element, 123
- World Geodetic Standard. *See* WGS 84
- WSAtkins
 - NaPTAN development, 15
- XML
 - Correctness, 29
 - Naming Conventions, 20
 - Notations, 21
 - Validation, 29
 - Well-formedness, 29
- XML.xsd
 - Package, 202
- xml:lang
 - Attribute, 186
- xml:lang:
 - NaPTAN Schema, 100
 - NPTG Schema, 90
- xsd
 - files, 202
 - NaPTAN, 15